



BLACKHAWK!®

2013

FULL LINE CATALOG

CELEBRATING 20 YEARS

1993-2013

BLACKHAWK.com

2013 PRODUCT SPOTLIGHT



Diversion™ Line

Our new Diversion line goes beyond “discreet” or “concealed” by mimicking everyday gym bags, sports equipment bags or casual packs. See page 49 – 51.



GripBreak™ Holsters

Introducing the GripBreak Holster, offering a unique retention experience in a sturdy design. See leather and nylon models on page 132 and 138.



Epoch™ Holster

Our long-awaited light-bearing retention holster is here! The new Epoch Level 3 Light Bearing Duty Holster accommodates the most popular under-barrel lights on the market. See page 125.



Watches

Our straightforward yet remarkably reliable timepiece designs let you choose from a variety of price points, function elements and styles to help you complete your mission. See page 29 – 36.



Women's Apparel

With the number of women in law enforcement on the rise, we've recognized a need in the industry for apparel that's specifically designed for the tactical woman. See page 261 – 264.

Sportster™

Our Sportster shooting gear is designed to give novice and casual shooters exceptional quality and durability at a price that fits any budget. See page 226 – 238.



Interact with us online:



BLACKHAWK!

2013

ACCESSORIES	2	KNIVES	162
APPAREL	3	LOAD BEARING	172
ARMOR	39	LONG GUN ACCYS	173
BAGS AND PACKS	49	PATCHES	195
BELTS	81	POUCHES	196
CHEST RIGS	86	PROTECTIVE GEAR	215
DUTY GEAR	89	SPORTSTER	226
ENTRY TOOLS	94	STOCKS	239
FLASHLIGHTS	111	THIGH RIGS	250
FOOTWEAR	115	VESTS	254
HANDGUN ACCYS	119	WATCHES	261
HOLSTERS	120	ORDER FORMS	265

Founded in 1993 by a U.S. Navy SEAL, BLACKHAWK!® has been leading the charge in the tactical industry, producing durable, high-quality gear for the military, law enforcement, corporate security, shooting sports and first responder markets. What started as a small operation in a garage has transformed into an enterprise that is now widely recognized as the ops gear of choice for Special Operation units worldwide. At BLACKHAWK!, excellence isn't just an aspiration—it's a way of life.

Accessories



5 mm lanyard with detachable 3 mm rope end

C.I.A. Lanyard

The C.I.A. (Credentials Information Access) Lanyard is the perfect carrier for your CAC card or other electronic ID. Cards slide in quickly, lock into place and can be removed easily.

- Two-sided smart-card holder protects up to two access cards for security and convenient access
- 5 mm lanyard with detachable 3 mm rope end

90ID03 | BK | \$16.99

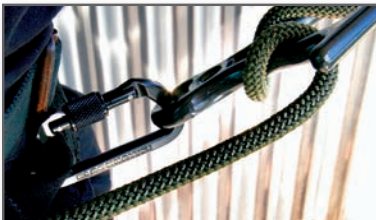

Locking and Non-Locking Carabiners

- Black anodized aluminum
- Non-packaged bulk orders available
- Working load strength force rated to 26kN in excess of 5,800 lbs.

Non-Locking | 98NC00 | BK | \$16.99
 Locking | 98LC00 | BK | NSN# 8465-01-529-6148 | \$22.99



Personal Retention Lanyard

- Tubular webbing and internal shock cord
- Locking carabiners at each end
- Five bar tacks on each end secure internal shock cord and create "biner" loops
- Third-party tested tensile strength in excess of 1500 lbs.

15" Relaxed/19" Stretched | 990453 | OD | NSN# 4240-01-502-9401 | \$25.99
 23" Relaxed/31.5" Stretched | 990802 | BK, OD | NSN# 4240-01-523-5193 (OD) | \$27.99

Caution: Test, practice and be aware of capabilities prior to "real world" use. Each situation and weight load requires proper planning and testing. For single person use only.



Includes a clear vinyl pouch for additional ID

ID-Badge Hanger

Designed for quick access, the ID-Badge Hanger can be worn around your neck or put in a jacket breast pocket.

- Lid is secured with hook & loop
- Two slip pockets for passport, ID, business cards, money, etc.
- Pen pouch for quick access
- Dimensions: 5.3"L x 3.8"W x .3"D

90ID01 | BK | NSN# 8455-01-529-5688 | \$13.99



Nalgene® Bottle

Combining the popular features of a 32-oz. polycarbonate bottle with convenient one-handed operation, the Nalgene Bottle with BLACKHAWKI® logo is the perfect companion for a long day on the job or on the trail. The large cap can be removed for cleaning or adding ice.

67NB32 | GR, GY | \$14.99



Nalgene® Canteen

Constructed of BPA-free, impact-resistant Tritan™ copolyester, the MIL-STD 1-qt. Nalgene Canteen resists unwanted tastes and smells while carrying either hot or cold beverages.

- Military thread configuration accommodates issued NBC caps
- Translucent color shows fluid level and cleanliness
- Temperature range of -40°F to 212°F (freezer and microwave safe)
- Dishwasher safe (top rack)
- Looped top for easy carrying by hand or carabiner
- Sized to military specifications to fit in issued canteen cups and pouches

With BLACKHAWKI® Logo | 67NC00 | CT, FG | \$15.99

Without Logo | 67NC01 | CT, FG | \$15.99

With Custom Logo | 67NCPL | CT, FG | \$19.99



Integrated Tourniquet System® (I.T.S.®)

With the advent of body armor, the most common cause of preventable deaths in the tactical environment can be attributed to rapid blood loss due to extremity wounds. A major arterial wound can cause the victim to become unconscious within two minutes, bleed out and expire moments later.

Thanks to the BLACKHAWK! Integrated Tourniquet System (I.T.S.), we have the solution. This revolutionary technology integrates tourniquets into the legs and arms of each BLACKHAWK! HPFU™ garment (see page 4 – 5). The tourniquets are strategically positioned and oriented to the upper and lower extremities for immediate access under existing gear and can be operated by the wearer, a buddy or a medic.

I.T.S.® benefits:

- Tourniquets are always present
- Combined weight is less than one traditional tourniquet
- Single-handed operation
- Flip/pull/twist activation
- Activation complete in seconds
- Safe and secure lockdown
- Complete occlusion of blood
- Ability to train to build muscle memory
- Useful in training scenarios

Did you know? 60% of preventable combat deaths are from extremity bleeding, and 50 – 70% of all combat injuries are extremity wounds.



High Performance Fighting Uniform (HPFU™)

The HPFU is a modern approach to the combat uniform, featuring a lean, athletic cut with no-melt, no-drip cotton/nylon ripstop construction. The original HPFU incorporates four life-saving tourniquets into the arms and legs of each garment while the HPFU V.2 features two tourniquets in each garment. The low-profile HPFU Slick omits the tourniquets altogether.

Materials:

- Black, Olive Drab & Desert Digital: 70% cotton/30% nylon ripstop
- MultiCam®: 50% nylon/50% cotton ripstop

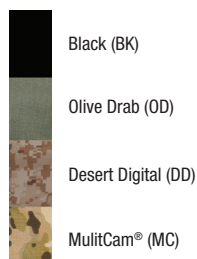



HPFU™ Pants

- Four tourniquets built into upper and lower legs (HPFU™ Pants, 87HP07)
- Two tourniquets built into upper legs (HPFU™ V.2 Pants, 87HP27)
- No tourniquets included (HPFU™ Slick, 87HP17)
- Padded, adjustable waistband for increased comfort and mobility when wearing fully loaded tactical belt
- Vertically mounted zippered pocket on top of cargo pocket for easy access while seated
- Reinforced belt loops accommodate BLACKHAWK!® CQB/Rigger's Belt (sold separately, see page 81) or other belts up to 1.75" wide
- Gusseted crotch and reinforced seat
- Blousing ties on leg cuffs
- Integrated knee pad pockets with cinch straps on back of knees to stabilize pads (pads sold separately, see page 225)
- Externally mounted guide loops stabilize BLACKHAWK!® or other knee pads for outside-the-pants wear (1" or 2" width)

HPFU™ Pants | 87HP07 | BK, OD, DD | 28" – 44" Even Waist, 30" – 36" Even Inseam | \$159.99

HPFU™ V.2 Pants | 87HP27 | BK, OD, DD, MC | 28" – 44" Even Waist, 30" – 36" Even Inseam; 46" – 54" Even Waist, 39" Inseam | \$139.99 (MC = \$179.99)

HPFU™ Slick Pants | 87HP17 | BK, OD, DD, MC | 28" – 44" Even Waist, 30" – 36" Even Inseam; 46" – 54" Even Waist, 39" Inseam | \$129.99 (MC = \$169.99)

MultiCam® is designed to camouflage the wearer in a wide range of environmental conditions in both visual and near infrared (night vision) spectrums.

HPFU™ Combat Shirts

Sleeves:

- Four tourniquets built into upper and lower arms (HPFU™ Combat Shirt, 87HP02)
- Two tourniquets built into upper arms (HPFU™ V.2 Combat Shirt, 87HP22)
- No tourniquets included (HPFU™ Slick Combat Shirt, 87HP12)
- Raglan-style sleeves for full range of motion
- Snug tapered cuffs with wrist adjustment
- Horizontal hook & loop mounting on sleeves

Torso:

- Zippered mock neck for added ventilation
- Comfortable cotton/modacrylic/spandex blend
- Superior breathability and moisture-wicking comfort especially for wear under plated armor
- Antimicrobial technology prevents growth of odor-causing microbes

HPFU™ Combat Shirt | 87HP02 | BK, OD, DD | SM – 2XL | \$159.99

HPFU™ V.2 Combat Shirt | 87HP22 | BK, OD, DD, MC | SM – 3XL | \$129.99 (MC = \$159.99)

HPFU™ Slick Combat Shirt | 87HP12 | BK, OD, DD, MC | SM – 3XL | \$109.99 (MC = \$139.99)



HPFU™ Vests

- No tourniquets included
- Can be worn over Combat Shirt for warmth and protection or for a full-jacket look for acceptable appearance in garrison
- Tuxedo-cut is shorter in front for easy access to belt-mounted items
- Hook & loop mounting points for ID patches, etc.

HPFU™ Vest | 87HP05 | BK, OD, DD | SM – 2XL | \$59.99

HPFU™ V.2 Vest | 87HP25 | BK, OD, DD, MC | SM – 3XL | \$59.99 (MC = \$79.99)

HPFU™ Slick Vest | 87HP15 | BK, OD, DD, MC | SM – 3XL | \$59.99 (MC = \$79.99)



HPFU™ Jackets

- Four tourniquets built into upper and lower arms (HPFU™ Jacket, 87HP04)
- Two tourniquets built into upper arms (HPFU™ V.2 Jacket, 87HP24)
- No tourniquets included (HPFU™ Slick Jacket, 87HP14)
- Can be worn instead of Combat Shirt and Vest combination or as a final layer jacket
- Tuxedo-cut is shorter in front for easy access to belt-mounted items
- Hook & loop mounting points for ID patches, etc.
- Integrated elbow pad pockets (pads sold separately, see page 225)
- Horizontal VELCRO® loop on flap of upper pockets

HPFU™ Jacket | 87HP04 | BK, OD, DD | SM – 2XL | \$159.99

HPFU™ V.2 Jacket | 87HP24 | BK, OD, DD, MC | SM – 3XL | \$139.99 (MC = \$169.99)

HPFU™ Slick Jacket | 87HP14 | BK, OD, DD, MC | SM – 3XL | \$119.99 (MC = \$149.99)



Modern Dress Uniform (MDU)

Set the standard with our Modern Dress Uniform! Featuring a sleek, multifunctional design, the MDU Field Shirt delivers a generous fit that can be worn as a jacket over other shirts or cinched at the waist for a tighter contoured fit. Wear the MDU Field Shirt with the athletic-fit MDU Pants to complete the two-piece uniform.



Inverted pleat back



MDU Field Shirt

- Constructed of 5.1 oz. 65% polyester/35% cotton ripstop blend
- DWR (Durable Water Repellent) treatment resists stains and dries quickly
- Structured VELCRO® tabbed waistband can be cinched for tighter fit
- Traditional notched collar and collar stand
- Full-buttoned placket center-front opening
- Colorfast, high-temperature-resistant buttons
- Long sleeves with sleeve roll-up tabs, hidden elbow pad pockets and adjustable cuffs (pads sold separately, see page 225)
- Expandable, top-opening front pockets with zippered side-entry mesh pocket
- Dual pencil pockets near placket
- Inverted pleat back for comfort and range of motion
- No tourniquets included

87MD14 | BK, OD | SM – 3XL | \$69.99

MDU Pants

- Constructed of a 6.1 oz. 65% polyester/35% cotton ripstop blend
- DWR (Durable Water Repellent) treatment resists stains and dries quickly
- Structured VELCRO® tabbed waistband can be cinched for tighter fit
- Front fly tab with hook & loop for extra security
- High-quality YKK® zippers and Prym® snaps
- Gusseted crotch for increased movement
- Side hand pocket with partial mesh pocket bags
- Rear VELCRO® flap pockets with mesh pocket bags
- Large expandable, top-opening cargo pockets with zippered side entry
- Double layering in seat and knees for added wear and protection
- Integrated knee pad pockets (pads sold separately, see page 225)
- Drawstring-adjustable blousing leg openings
- No tourniquets included

87MD17 | BK, OD | 28" – 44" Even Waist, 30" – 36" Even Inseam; 46" – 54" Even Waist, 39" Unhemmed Inseam without Blousing | \$69.99

Men's Pants

Our men's pants are designed to give you everything you need for extreme performance—durability, comfort and utility. From our popular Lightweight Tactical Pants to the rugged Performance Cotton Pants, each pair comes equipped with the following standard features:

- High-quality YKK® zippers and Prym® snaps
- Gusseted crotch for increased movement
- Silicone grip strip in waistband keeps shirt tucked in during extreme maneuvers
- Reinforced belt loops accommodate BLACKHAWK!® CQB/ Rigger's Belt (sold separately, see page 81) or other belts up to 1.75" wide
- Hidden expandable waistband slides to increase waist size for improved mobility and ease of holster placement
- Angle-cut hand pockets with flat edges for proper placement and orientation of knives, pens, etc.

Performance Cotton Pants

These rugged tactical pants are designed with high-performance materials and come equipped with a number of innovative features for optimum performance.

- Traditional fit
- Includes all standard pant features (see top of page)
- Constructed of durable, wrinkle- and fade-resistant 8.5 oz. cotton canvas
- Double layering in seat and knees for added wear and protection
- Easy-access, top-opening mag pouch on each leg
- Large top-opening cargo pockets with segmented 2" elastic webbing inside for intelligent storage of up to three mags, flashlights, knives or other items for quick access
- Vertical zippered storage pocket outside each cargo pocket for easy access while seated
- Zippered rear hip pocket keeps wallet secure and separate from large rear pockets
- 550 cord loop on front waistband for attaching carabiners or other items
- Reinforced hems on leg cuffs and hand pockets for increased durability
- Integrated knee pad pockets (pads sold separately, see page 225)

86TP03 | BK, KH, OD, NA | 28" Waist, 30" – 32" Inseam; 30" Waist, 30" – 34" Even Inseam; 32" – 44" Even Waist, 30" – 36" Even Inseam, 46" – 54" Even Waist, 39" Unhemmed Inseam | \$64.99

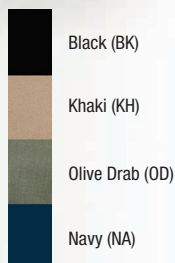

Large hidden zippered pocket behind right-hand pocket





Lightweight Tactical Pants

The Lightweight Tactical Pants combine all the features you look for in a multifunctional tactical pant but are made with a lightweight, water-resistant 6.5 oz. polyester/cotton ripstop blend for warmer climates.

- Traditional fit
- Includes all standard pant features (see page 7)
- Constructed of durable 6.5 oz. 65% polyester/35% cotton ripstop fabric
- DWR (Durable Water Repellent) treatment resists stains and dries quickly
- Double layering in seat and knees for added wear and protection
- Easy-access, top-opening mag pouch on each leg
- Large top-opening cargo pockets with segmented 2" elastic webbing inside for intelligent storage of up to three mags, flashlights, knives or other items for quick access
- Vertical zippered storage pocket outside each cargo pocket for easy access while seated
- Large hidden zippered pocket behind right-hand pocket keeps valuable items secure but quickly accessible
- 550 cord loop on front waistband for attaching carabiners or other items
- Reinforced hems on leg cuffs and hand pockets for increased durability



86TP02 | BK, KH, OD, NA, CB | 28" Waist, 30" – 32" Inseam; 30" Waist, 30" – 34" Even Inseam; 32" – 44" Even Waist, 30" – 36" Even Inseam, 46" – 54" Even Waist, 39" Unhemmed Inseam | \$64.99



Vertical zippered storage pocket outside each cargo pocket



Zippered pocket and angle-cut hand pocket

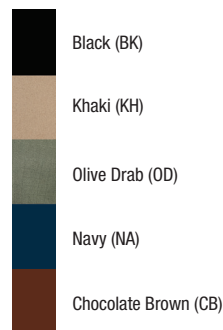

LT2 Tactical Pants **NEW!**

Being prepared means having the right tools with you at any given moment. Featuring multiple pockets and intelligent storage options, the LT2 Tactical Pants let you keep your tactical necessities nearby for quick access—anywhere, anytime.

- Traditional fit
- Includes all standard pant features (see page 7)
- Constructed of durable 6.5 oz. polyester/cotton ripstop
- DWR (Durable Water Repellent) treatment resists stains and dries quickly
- Double layering in seats and knees for added wear and protection
- Two deep front and back pockets
- Large top-opening cargo pockets with segmented 2" elastic webbing inside for intelligent storage of up to three mags, flashlights, knives or other items for quick access

86TP06 | BK, KH, OD, NA, CB | 28" – 44" Even Waist, 30" – 36" Even Inseam; 46" – 54" Even Waist, 39" Unhemmed Inseam | \$49.99



Ultralight Tactical Pants **WHILE SUPPLIES LAST**

Constructed of a sleek cotton/nylon blend, the Ultralight Tactical Pants' woven fabric is slightly brushed on the face surface while a smooth underside provides next-to-skin comfort, making them perfect for casual wear or performance-oriented tasks.

- Modern fit
- Includes all standard pant features (see page 7)
- Constructed of lightweight 5.5 oz. cotton/nylon blend
- DWR (Durable Water Repellent) treatment resists stains and dries quickly
- Double layering in knees for added wear and protection
- Large back patch pockets
- Reinforced hems on leg cuffs and hand pockets for increased durability
- Integrated knee pad pockets (pads sold separately, see page 225)

86TP05 | BK, KH, NA | 28" Waist, 30" – 32" Inseam; 30" Waist, 30" – 34" Even Inseam; 32" – 44" Even Waist, 30" – 36" Even Inseam, 46" – 54" Even Waist, 39" Unhemmed Inseam
\$79.99

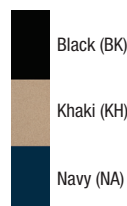

Dress Pants **NEW!**

Wear these multifunctional pants to official events, for court assignments or while working undercover. No matter where you choose to take them, the sleek design will keep you looking sharp—even when carrying concealed.

- Traditional fit
- Includes all standard pant features (see page 7)
- Constructed of quick-dry, wrinkle- and fade-resistant 93% nylon/7% spandex two-way stretch twill with UV protection (UPF40+)
- DWR (Durable Water Repellent) treatment resists stains and dries quickly
- Hidden pockets on side seams

86TP071 BK, KH, NA, GR | 28" Waist, 30" – 32" Inseam; 30" Waist, 30" – 34" Even Inseam; 32" – 44" Even Waist, 30" – 36" Even Inseam, 46" – 54" Even Waist, 39" Unhemmed Inseam | \$69.99



Lightweight Tactical Shorts

The Lightweight Tactical Shorts are a short version of our popular Lightweight Tactical Pants with the same durable polyester/cotton ripstop fabric.

- Traditional fit
- Includes all standard pant features (see page 7)
- Constructed of durable 6.5 oz. 65% polyester/35% cotton ripstop fabric
- DWR (Durable Water Repellent) treatment resists stains and dries quickly
- Double layering in seat for added wear and protection
- Easy-access, top-opening mag pouch on each leg
- Large top-opening cargo pockets with segmented 2" elastic webbing inside for intelligent storage of up to three mags, flashlights, knives or other items for quick access
- Vertical zippered storage pocket outside each cargo pocket for easy access while seated
- Large hidden zippered pocket behind right-hand pocket keeps valuable items secure but quickly accessible
- 550 cord loop on front waistband for attaching carabiners or other items

86TS02 | BK, KH, OD, NA | 28" – 54" Even Waist | \$59.99

- Black (BK)
- Khaki (KH)
- Olive Drab (OD)
- Navy (NA)





Lightweight Tactical Shirt

The Lightweight Tactical Shirt comes equipped with water-resistant fabric treatment and mesh detailing, making it the perfect option for warm weather.

- Traditional cut for a roomier fit
- Constructed of durable polyester/cotton ripstop
- DWR (Durable Water Repellent) treatment resists stains and dries quickly
- Concealed collar-stay buttons and anti-roll collar inserts
- Sewn eyelets on yoke for ventilation
- Mesh pocket bags and back yoke panel for increased ventilation
- Roll-up sleeves with button fasteners (Long Sleeve, 88TS01)
- Large, hook & loop-secured, top-opening, gusseted chest pockets
- Internal mesh catch-pocket secures a cell phone
- Slit in top of pocket flap allows pens to be inserted without opening
- Snap-down media player pocket on left sleeve with buttonhole for cord routing
- Hidden zipper pocket inside left pocket keeps items separate from large pocket
- Elastic cord loop on pocket flap to hang sunglasses, pens, etc.
- Hidden vertical zipper pocket underneath main pocket
- Additional zippered pocket hides below waistband when shirt is tucked in

Long Sleeve | 88TS01 | BK, KH, OD, NA, CB | SM - 3XL | \$59.99
Short Sleeve | 88TS02 | BK, KH, OD, NA, CB | SM - 3XL | \$56.99



-  Black (BK)
-  Khaki (KH)
-  Olive Drab (OD)
-  Navy (NA)
-  Chocolate Brown (CB)



Additional zippered pocket hides below waistband when shirt is tucked in

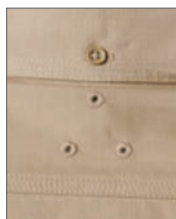

Strategically placed eyelets on back



Elastic cord loop on pocket flap

Performance Cotton Tactical Shirt

Our Performance Cotton Tactical Shirt has a clean-cut look while maintaining the function you would expect from a tactical shirt.

- Main body constructed of wrinkle-, fade- and stain-resistant 100% cotton canvas
- DWR (Durable Water Repellent) treatment resists stains and dries quickly
- Underarm constructed of breathable mesh knit polyester with moisture-wicking and antimicrobial finishes
- Traditional notched collar
- Colorfast, high-temperature-resistant buttons
- Saddle shoulder eliminates hot spots when layering or carrying a backpack
- Collar-stay bones inside tip of collar for professional look
- Button-down tabs keep collar in place
- Expandable, angled, top-opening flap chest pockets with hook & loop
- Discreet pen slots at top of chest pocket double as cord-routing holes for media player
- Small mesh pocket inside right chest pocket holds personal items, media player, etc.
- Hidden zipper pocket inside left pocket keeps items separate from large pocket
- Hidden vertical zipper pocket underneath main pocket

Long Sleeve | 88TS03 | BK, KH, OD, NA | SM - 3XL | \$59.99
Short Sleeve | 88TS04 | BK, KH, OD, NA | SM - 3XL | \$56.99

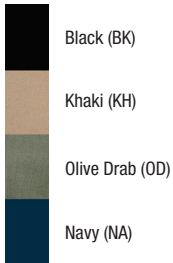

Breathable mesh knit underarms



Hidden zipper pocket inside left pocket



Hidden vertical zipper pocket underneath main pocket

LT2 Tactical Shirt **NEW!**

Be ready for anything that comes your way with the LT2 Tactical Shirt! This utilitarian shirt gives you the functionality you need in a lightweight, water-repellent package.

- Constructed of durable 5.1 oz. polyester/cotton ripstop
- DWR (Durable Water Repellent) treatment resists stains and dries quickly
- Concealed collar-stay buttons and anti-roll collar inserts
- Set-in sleeves with gusseted underarms for full range of motion
- Snap-down media player pocket on left sleeve with button hole for cord routing
- Two front pockets with tabs
- Elastic cord loop on pocket flap to hang sunglasses, pens, etc.

Long Sleeve | 88TS05 | BK, KH, OD, NA, CB | SM - 3XL | \$49.99

Short Sleeve | 88TS06 | BK, KH, OD, NA, CB | SM - 3XL | \$49.99



Long Sleeve Casual Shirt **NEW!**

Need the functionality of a tactical shirt but don't necessarily want to look like an operator? Combining a stylish plaid design with water-repellent finish, this is the perfect casual shirt for everyday wear.

- Traditional cut for a roomier fit
- Constructed of durable, wrinkle- and fade-resistant nylon/polyester or polyester/rayon blends
- DWR (Durable Water Repellent) treatment resists stains and dries quickly
- Mesh back yoke panel for increased ventilation
- Hidden front pocket under left chest pocket
- Available in Tan/White (TW), Navy (NB), Charcoal/Gray (CG) Burgundy (BG), Black (BK) and Black/Charcoal (BC)

88CS04-LS | TW, NB, CG, BG, BK, BC | SM - 3XL | \$49.99





Short Sleeve Casual Knit Shirt **NEW!**

The short-sleeve Casual Knit Shirt gives you all the utility you need but in a relaxed knit design.

- Relaxed Fit
- Constructed of lightweight, quick-dry, shrink- and wrinkle-resistant tencel blend
- Sandwashed for soft texture
- Pleated back yoke for ease of motion
- Low side slits for easy pant pocket and belt access
- Left side entry zippered chest pocket for quick access to passports, documents, etc.
- Available in Gray Tropical (YT), Green Tropical (GT) and Wine Tropical (WT)

88CS05 | YT, GT, WT | SM – 3XL | \$69.99

Tencel is a man-made fiber that's constructed with natural cellulose found in wood pulp. It's fully biodegradable and has a low impact on energy use and natural resources.



CCW Tech Hoodie **NEW!**

There's no better way to blend in when carrying concealed than by wearing the ever-popular hoodie! In this clever design, we've given you a discreet handgun access point in the hand-warmer pocket.

- Constructed of 100% polyester (BK, NA) or polyester blend (GH, HH)
- Access point behind front pocket for easy access to belt holster
- Hidden pocket on front pouch pocket
- Drawstring-adjustable hood for comfortable fit
- Clear resin print on elbows for added durability
- Drop shoulder seams for better fit
- Available in Black (BK), Navy (NA), Gray Heather (GH) and Hunter Green Heather (HH)

82FH00 | BK, NA, GH, HH | SM – 3XL | \$49.99

X-Ray view



Performance Polo NEW!

Work hard or play hard in our Performance Polo! Its lightweight nylon blend wicks moisture and keeps you cool in practically any environment.

- Modern fit
- Constructed of a proprietary 98% nylon blend with moisture-wicking treatment and SPF30
- Pique knitted back collar for added comfort and increased airflow at back neck
- Three-button placket
- Hanging loop at bottom of placket to hang sunglasses, pens, etc.
- Raglan-style sleeves with gusseted underarms for full range of motion
- Flat-knit collar with anti-roll inserts
- Extended tuxedo-style shirt tails
- Makes a great Class B uniform shirt

88PP02 | BK, NA, RB, GW, RR, WH | SM - 3XL | \$49.99



Available Colors:
Black (BK)
Navy (NA)
Royal Blue (RB)
Gray Stripe (GW)
Range Red (RR)
White (WH)



Call about our
custom embroidery program!
800.694.5263



Cotton Polo NEW!

The Cotton Polo Shirt combines classic styling, moisture-wicking treatment and lightweight materials to provide all-around comfort in the field, on the range or in the office.

- Modern fit
- Constructed of lightweight, fade-resistant 100% cotton pique knit
- Pique knitted back collar for added comfort and increased airflow at back neck
- Three-button placket
- Hanging loop at bottom of placket to hang sunglasses, pens, etc.
- Raglan-style sleeves with gusseted underarms for full range of motion
- Flat-knit collar with anti-roll inserts
- Extended tuxedo-style shirt tails
- Makes a great Class B uniform shirt

88CP02 | BK, NA, HG, RR, RB, WH | SM - 3XL | \$39.99



Available Colors:
Black (BK)
Navy (NA)
Hunter Green (HG)
Range Red (RR)
Royal Blue (RB)
White (WH)

1700 Shirt

Our breathable, easy-care 1700 Shirt is ideal for warm-weather concealed carry. The roomy fit lets you move freely while a textured plaid design helps minimize weapon print.

- Constructed of wrinkle-resistant, quick-dry polyester blend with UV protection (UPF30+)
- Left side-entry zippered chest pocket for quick access to passports, boarding passes, etc.
- Pleated back yoke for ease of motion
- Notched collar
- Low side slits for easy pant pocket and belt access
- Pattern options include:
 - Flat weave solid (Slate or Clay)
 - Textured medium plaid to discreetly conceal weapon (Blue, Green, Khaki Blue or Gray Green)

88CS03 | GN, BL, CL, SL, KB, GG | SM - 3XL | \$49.99

Slate
(SL)

Clay
(CL)

Blue Plaid
(BL)

Green Plaid
(GN)

Gray Green
(GG)

Khaki Blue
(KB)

Fun Fact: The plaid 1700 Shirt chest pocket is cut on a diagonal to draw attention to the chest and away from the concealed firearm at your waist.



Flag T-Shirt

Nothing says "patriotism" like a star-spangled T-shirt. Constructed of 100% cotton, this simple short-sleeve design features the BLACKHAWK!® logo on the front with an American flag on the back.

90ST00 | WH | MD - 2XL | \$14.99

Logo T-Shirt

Nothing says "patriotism" like a star-spangled T-shirt. Constructed of 100% cotton, this simple short-sleeve design features the BLACKHAWK!® logo on the front with an American flag on the back.

90ST01 | WH | MD - 2XL | \$14.99



Dynamic Entry® Knock Knock T-Shirt

Constructed of 100% cotton, this clever short-sleeve T-shirt makes a big impact.

90KK01 | BK | MD - 2XL | \$14.99



Dirtbag T-Shirt

This cotton short-sleeve T-shirt says it all: "Making the world a safe place...one dirtbag at a time."

90DB02 | WH | MD - 2XL | \$14.99



Memory Graphic T-Shirt with Color Flag (90GT04)



Patrol Graphic T-Shirt (90GT01)



Memory Graphic T-Shirt with Gray Flag (90GT00)



Scope Graphic T-Shirt (90GT02)



Crest Graphic T-Shirt (90GT03)



Graphic T-Shirts **NEW!**

Rock the BLACKHAWK! logo in style with these casual T-shirts, featuring edgy graphics and tactical-inspired designs.

- Constructed of 50/50 ringspun cotton
- Modern graphics
- Short sleeves

Memory Graphic T-Shirt with Gray Flag | 90GT00 | BK, GH, WH | SM – 3XL | \$14.99

Memory Graphic T-Shirt with Color Flag | 90GT04 | BK, GH, WH | SM – 3XL | \$14.99

Patrol Graphic T-Shirt | 90GT01 | BK, NA, WH | SM – 3XL | \$14.99

Scope Graphic T-Shirt | 90GT02 | BK, GH, WH | SM – 3XL | \$14.99

Crest Graphic T-Shirt | 90GT03 | BK, GH, WH | SM – 3XL | \$14.99



Graphic Hoodie **NEW!**

This traditional-fit 100% cotton design has everything you want in a casual hoodie—full-zipper opening, front pockets and long sleeves.

- Constructed of 100% cotton (BK, WH) or cotton blend (HG)
- Long sleeves
- Traditional-fit design
- Front pockets
- Available in Black (BK), Heather Gray (HG) and White (WH)

82GH00 | BK, HG, WH | SM – 3XL | \$39.99

Men's Athletic Shirts

Constructed of a soft, ultra-lightweight polyester/bamboo blend, our athletic shirts give you everything you need for a long PT session or day at the shooting range. We incorporated bamboo into the fabric to make each shirt naturally antibacterial, antifungal, anti-static, hypoallergenic, moisture wicking and absorbent. All three athletic shirts include the following standard features:

- Constructed of lightweight polyester/bamboo blend fabric
- Double knit pique
- Raglan-style sleeves for full range of motion
- Moisture-wicking and antimicrobial finishes
- Tagless labels at neck for comfort
- Solid colors with contrast color inserts at shoulder, back neck, underarm and sides:
 - Black with Gray (BK)
 - Navy with Gray (NA)
 - Gray with Navy (GY)

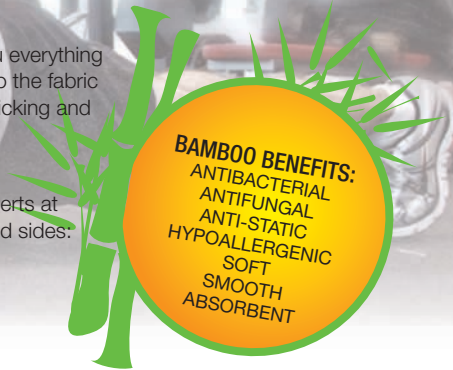

Athletic Polo – Short Sleeve

Featuring classic styling with a modern twist, the high-performance Athletic Polo gives you the best of both worlds. Wear it on the range, golf course, boat or sidelines!

- Includes all standard athletic shirt features (see top of page)
- Short raglan-style sleeves for full range of motion
- Self fabric collar with anti-roll inserts
- Three-button placket front
- Snap-down media player pocket on left sleeve with button hole for cord routing

88AP00 | BK, NA, GY | SM – 3XL | \$39.99



Athletic 1/4-Zip Mock Top – Long Sleeve

Wear the long-sleeve Athletic 1/4-Zip Mock Top at the gym or shooting range. A mock neckline with quarter-zip placket gives you the option of added ventilation while a moisture-wicking finish helps you stay dry and cool when the heat is on.

- Includes all standard athletic shirt features (see top of page)
- Long raglan-style sleeves for full range of motion
- Protective inside zipper cover and chin guard
- Quarter-zip placket

88AZ01 | BK, NA, GY | SM – 3XL | \$42.99



Athletic Crew Top – Short Sleeve

Kick off your workout in our Athletic Crew Top. Featuring breathable, moisture-wicking, odor-fighting materials, this short-sleeve shirt delivers weightless comfort for the hardcore athlete.

- Includes all standard athletic shirt features (see top of page)
- Short raglan-style sleeves for full range of motion
- Crew neck pullover

88AT00 | BK, NA, GY | SM – 3XL | \$36.99





Men's Athletic Shorts

Whether you're gearing up for Crossfit, P90X, Insanity or a tough PT session, our athletic shorts are the perfect companion for any workout addiction. Both shorts include the following standard features:

- Constructed of lightweight, woven 100% polyester
- Quick-drying fabric with UV protection (UPF 40+)
- Fabric-covered elastic and drawstring waistband
- Discreet envelope coin pocket inside
- Birdseye knit panels on lower back and lower side leg
- Zippered pocket at upper right hip
- Available in solid colors (Black or Gray)



Short Athletic Shorts

Featuring quick-drying fabric and UV protection, these shorts will take your performance to new heights without weighing you down.

- Includes all standard athletic shorts features (see top of page)
- Knit liner brief with elastic leg openings
- Ample 5" inseam

86AS00 | BK, GY | SM – 3XL | \$34.99

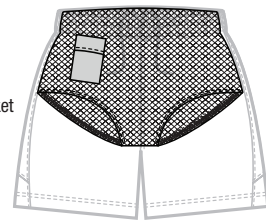

Built-in brief short liner and key pocket



Long Athletic Shorts

Combining a compression-fit liner with a comfortable 9" inseam outer short, our Long Athletic Shorts are designed to help you go that extra mile.

- Includes all standard athletic shorts features (see top of page)
- Long compression-fit liner
- Generous 9" inseam

86AS01 | BK, GY | SM – 3XL | \$38.99



Built-in compression short liner and key pocket

Thermostatic Base-Layer™ Garments

Engineered Fit™ Series

Designed for maximum comfort and freedom of movement, our Thermostatic Base-Layer™ Garments regulate body temperature, wick moisture, dry quickly and control odor. The Engineered Fit™ Series allows you to choose between a body-contoured Standard Fit and full Compression Fit simply by size selection. Select one size down from your normal size to achieve a Compression Fit—a true next-to-skin, no-movement fit—which eliminates potential friction-related “hot spots” and helps reduce muscle fatigue. Each garment comes equipped with the following standard features:

- Body: Jersey knit 92% nylon/8% spandex
- Panels: 82% polyester/18% spandex
- Modern athletic fit
- Antimicrobial treatment inhibits growth of bacteria and prevents odor
- Smooth matte-finish face surface reduces drag and bulk when layering
- Soft jacquard elastic waistband
- Fast drying



Mesh Panel Construction:
Strategically placed mesh panels enhance freedom of movement and heat dissipation.



Flat-Seam Technology:
Innovative flat-seam stitching technique minimizes irritation in the seam areas



Moisture Wicking:
Brushed interior fabric breaks up fibers to enhance moisture-wicking performance via capillary action. Additional moisture-wicking treatment helps repel moisture.



Engineered Fit™
Unique material technology allows you to choose between a body-contoured Standard Fit and full Compression Fit simply by size selection.

Size Selection:

To find your size, look up your measurements in the chart below. As demonstrated in the chart, if your chest measures from 42” – 44” and you prefer a body-contoured Standard Fit, choose size Large. If you prefer a full Compression Fit, simply size down to a size Medium.

FITTING CHART (In inches, using chest size for tops and waist size for bottoms)						
SHIRT SIZE	34"-36"	38"-40"	42"-44"	46"-48"	50"-52"	54"-56"
Standard Fit	SM	MD	LG	XL	2XL	3XL
Compression Fit	N/A	SM	MD	LG	XL	2XL
BOTTOM SIZE (BOXER BRIEFS, ETC.)	28"-30"	32"-34"	36"-38"	40"-42"	44"-46"	48"-50"
Standard Fit	SM	MD	LG	XL	2XL	3XL
Compression Fit	N/A	SM	MD	LG	XL	2XL



- For Standard Fit: select exact size
- Compression Fit: select one size down from your normal size



Engineered Fit™ Long Sleeve 1/4-Zip Mock Neck

- Includes all standard Engineered Fit™ features (see top of page)
- Sleek quarter-zip front with mock neck for ventilation
- Protective zipper flap and chin guard

84BS01 | BK, CT, FG, WH | SM – 3XL | \$54.99





Engineered Fit™ Short Sleeve Crew Neck

- Includes all standard Engineered Fit™ features (see page 21)
- Crew neck is form-fitting and comfortable

84BS05 | BK, CT, FG, WH | SM – 3XL | \$39.99



Engineered Fit™ Short Sleeve V-Neck

- Includes all standard Engineered Fit™ features (see page 21)
- V-neck design for wear under button-down shirt

84BS03 | BK, CT, FG, WH | SM – 3XL | \$39.99



Engineered Fit™ Long Sleeve Crew Neck

- Includes all standard Engineered Fit™ features (see page 21)
- Crew neck is form-fitting and comfortable

84BS04 | BK, CT, FG, WH | SM – 3XL | \$49.99



Engineered Fit™ Long Bottoms

WHILE SUPPLIES LAST

- Includes all standard Engineered Fit™ features (see page 21)
- Comfortable 1" elastic waistband

84BB02 | BK, CT, FG, WH | SM – 3XL | \$49.99



Engineered Fit™ Boxer Briefs

- Includes all standard Engineered Fit™ features (see page 21)
- Comfortable 1" elastic waistband
- 6" inseam

84BB01 | BK, CT, FG, WH | SM – 3XL | \$24.99

Advanced Waterproof Jacket **NEW!**

The Advanced Waterproof Jacket provides outstanding coverage thanks to its impermeable construction, strategically placed storm flaps and sleek articulated hood. When not in use, the hood can be unzipped and stored inside a pocket.

- Constructed of 100% nylon three-layer waterproof, breathable fabric (plus additional 2.5-layer waterproof, breathable fabric)
- Adjustable waist for comfortable fit
- Front storm flaps keep water out
- Adjustable hood zips into back collar and snaps into front collar (right and left side)
- Pop-out flaps with VELCRO® to attach badges or shields
- Zippered side seams for ventilation
- Gusseted cuff opening
- Discreet hidden pockets at bicep and right front

82WJ00 | BB, NB, GG | SM – 3XL | \$299.99



Advanced Waterproof Pants **NEW!**

Whether you wear them alone or as an over-pant, these breathable, waterproof pants are uniquely designed to repel the elements—perfect for working in the rain or hitting the slopes.

- Constructed of 100% nylon three-layer waterproof, breathable fabric (plus additional 2.5-layer waterproof, breathable fabric)
- VELCRO® straps at hem and articulated knees for adjustable fit
- Reinforced hems on leg cuffs for increased durability
- Zippered side seams for ventilation
- Double layering in seat and knees for added wear and protection

82WP00 | BB, NB, GG | SM – 3XL | \$169.99



Advanced Soft Shell Jacket **NEW!**

This streamlined soft-shell jacket keeps your valuables secure and in place while shielding you from chilly weather. With seamless shoulders, underarms and sides, it helps prevent water penetration and is your best option for bulk-free warmth.

- Constructed of three-layer 100% polyester soft shell with sealed outer seams
- DWR (Durable Water Repellent) treatment resists stains and dries quickly
- Provides wind and water resistance with excellent breathability
- Bonded fleece interior
- YKK® center-front zipper with semi-auto locking slider and windproof back flap
- Hidden, locking drawstring waist adjustment in hand pockets
- YKK® zipper-sealed waterproof outer pockets: two front pockets, one breast pocket, left bicep pocket, right lower arm pocket, large rear “tailbone” pocket with left or right (two-side) access

82FJ09 | BK, NA, BL | SM – 3XL | \$224.99



Jacket System

This unique jacket system consists of three jackets designed to be used separately or layered in combination with each other depending on the temperature, elements and wearer's need for insulation, ventilation, wind protection or water resistance. Jackets are sold separately only.

Training Jak – Layer 1

The lightweight soft-shell Training Jak is the first layer in our versatile jacket system. Designed for moderate warmth while training or in the field, it provides excellent protection in mild conditions.

- Water-resistant, windproof, breathable 100% polyester three-layer laminate
- DWR (Durable Water Repellent) treatment resists stains and dries quickly
- Comfortable microfleece brushed tricot collar lining
- Stretch panels for lean, athletic fit
- Raglan-style sleeves for full range of motion
- YKK® center-front zipper with semi-auto locking slider
- Zippered chest pocket

82TJ00 | BK, FG, NA | SM – 3XL | \$99.99

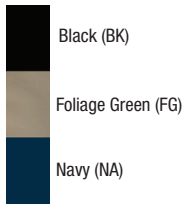

Ops Jak – Layer 2

The rugged Ops Jak is the second layer in our jacket system, providing substantial warmth and element protection in a lean, high-performance package. This windproof, water-repellent soft-shell jacket is perfect for cold conditions.

- Water-resistant, windproof, breathable 100% nylon (outer shell)/100% polyester (inner shell) three-layer laminate
- DWR (Durable Water Repellent) treatment resists stains and dries quickly
- Brushed tricot and brushed mesh collar and inner lining
- Sealed outer seams lock out the elements
- Scuff-resistant panels protect elbow and forearm
- YKK® center-front zipper with semi-auto locking slider and windproof back flap
- Hidden locking drawstring waist adjustment in hand pockets
- Three large YKK® zippered interior pockets
- YKK® waterproof zippered outer pockets:
 - Two hand pockets
 - One breast pocket
 - One large rear "tailbone" pocket with left or right (two-side) access

82OJ00 | BK, FG, NA | SM – 3XL | \$229.99

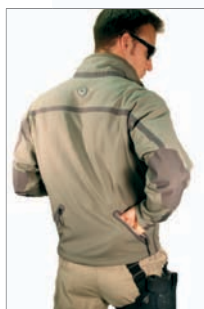
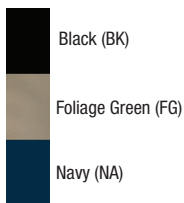

Large rear "tailbone" pocket



Shell Jak – Layer 3

Get extreme protection from the elements with the impermeable Shell Jak—the third layer in our multifunctional jacket system. This rugged jacket delivers long-lasting resilience thanks to its hard-shell laminate construction, sealed outer seams and rugged face fabric in high-abrasion areas.

- Constructed of waterproof, windproof, breathable 100% nylon three-layer laminate
- DWR (Durable Water Repellent) treatment resists stains and dries quickly
- Waterproof sealed seams throughout entire jacket and hood interior
- Comfortable microfiber brushed tricot collar lining and chin guard
- Rugged face fabric in high-abrasion areas
- Drawstring-adjustable waist and bottom hem keep elements out
- Stow-away hood with extended visor, face opening and crown drawstring adjustments for secure fit and unrestricted vision
- Hook & loop-adjustable cuffs
- Waterproof center-front storm flaps with dual-direction zipper
- Waterproof YKK® zippered external pockets
- Adjustable pit-zips for ventilation
- Internal zipper accommodates full-zip BLACKHAWK!™ fleece jackets (sold separately, see page 26 – 27) for additional warmth



Adjustable pit-zips

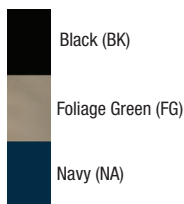

82ES00 | BK, FG, NA | SM – 3XL | \$299.99

Shell Pants – Layer 3

The Shell Pants are a waterproof over-pant designed for use with our Shell Jak to keep you dry and warm in extreme weather conditions. High-quality fabrics, design and construction ensure top performance.

- Traditional fit
- Constructed of waterproof, windproof, breathable three-layer laminate
- Waterproof sealed seams
- Rugged face fabric in high-abrasion areas
- Reinforced knees for increased durability
- Elasticized waist with built-in nylon web belt for secure fit
- Gusseted crotch for increased movement
- Zippered openings on legs for access to pockets on pants worn underneath
- Zippered leg cuffs with hook & loop adjustment open wide for easy donning and doffing



Zippered openings on legs for access to pockets on pants worn underneath



Zippered leg cuffs with hook & loop adjustment

86EP00 | BK, FG, NA | SM – 3XL | \$159.99

Size	Waist Measurement
SM	28" – 30"
MD	32" – 34"
LG	36" – 38"
XL	40" – 42"
2XL	44" – 46"
3XL	48" – 50"

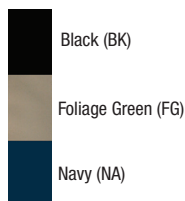

Bonded Microfleece Jacket **NEW!**

Whether you're hauling luggage, coaching little league baseball or rappelling down a building, the highly functional microfleece jacket is designed to protect you from biting wind thanks to its dual-layer bonded fleece construction.

- Constructed of two-layer bonded 100% polyester fleece
- Brushed finish prevents pilling
- Articulated elbows for unencumbered range of motion
- Dropped tail for additional coverage
- Seamless shoulder for comfortable fit and reduced bulk
- Forward-shifted side seams help prevent abrasion
- Front zipper garage protects neck/chin from zipper head

82FJ07 | BC, NC, BG, GG | SM - 3XL | \$69.99



Fleece Liner **WHILE SUPPLIES LAST**

The Fleece Liner features contemporary styling and plenty of warmth for wear alone, but it is especially designed to provide insulating comfort for our waterproof Shell Jak.

- Plush, wind-blocking 100% polyester fleece
- Raised collar keeps wind out and warmth in
- High-quality YKK® zippers and easy-grip pull tabs
- Hand pockets
- Compatible with BLACKHAWK!™ Shell Jak (sold separately, see page 25) via full-zippered front opening and securing tabs at back collar and sleeve cuffs

82FL01 | BK | SM - 3XL | \$72.99



Heavyweight Fleece Jacket **NEW!**

Layer the multifunctional Heavyweight Fleece Jacket under our BLACKHAWK! Advanced Waterproof Jacket for additional warmth, or wear it as a final-layer jacket on cool fall days.

- Constructed of 100% polyester fleece
- Brushed finish prevents pilling
- Elastic binding on cuffs, waist and pockets for snug fit
- Forward-shifted side seams help prevent abrasion
- Seamless shoulder for comfortable fit and reduced bulk
- Front zipper garage protects neck/chin from zipper head

82FJ06 | BK, NA, BL | SM - 3XL | \$79.99



Windproof Fleece Jacket NEW!

Featuring bonded microfleece construction, the Windproof Jacket is designed with functionality and comfort in mind. It effectively blocks cold air while offering a slim fit to prevent extra material from slowing you down.

- Constructed of windproof bonded 100% polyester microfleece
- Brushed finish prevents pilling
- Elastic binding on cuffs, waist and pockets for snug fit
- Dropped tail for additional coverage
- Seamless shoulder for comfortable fit and reduced bulk
- Forward-shifted side seams help prevent abrasion
- Front zipper garage protects neck/chin from zipper head

82FJ08 | BK, NA, BL | SM - 3XL | \$89.99



Windproof Fleece Vest NEW!

This stylish yet functional vest gives you a windproof barrier in a slim-fitting package. Featuring multiple pockets, it gives you plenty of storage options while you're on the go.

- Constructed of windproof bonded 100% polyester microfleece
- Brushed finish prevents pilling
- Internal chest pocket
- Front chest pocket and side seam pockets
- Back side seams with discreet pockets
- Drop shoulder seams for better fit
- Dropped tail for additional coverage
- Front zipper garage protects neck/chin from zipper head

82FV00 | BK, NA, GN | SM - 3XL | \$69.99



Rad Vest WHILE SUPPLIES LAST

This wind-blocking, breathable soft-shell vest with comfortable fleece lining provides ample warmth and wind protection to the torso. Its lean, contour-cut design with adjustable waist and medium-height collar keeps the heat in and the cold out.

- High-quality YKK® zippers and easy-grip pull tabs
- Drawstring-adjustable waist
- Zippered hand, chest and interior pockets
- Compatible with BLACKHAWK!™ Shell Jak (sold separately, see page 25) via full-zippered front opening

82VS04 | BK, SB | SM - 3XL | \$89.99

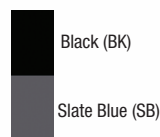

Job Shirt with Reflective Piping

The Station Wear Job Shirt is designed for station duty or casual off-duty wear.

- Constructed of 80% cotton/20% polyester heavyweight fleece
- Heavy woven duck elbow patches for abrasion resistance
- Reflective piping on outer seams, down inner arms and sides of body
- Raglan-style sleeves for full range of motion
- Designed to carry small duty items and accessories
- Quarter-zip mock neck with chin guard
- Easy-grip reflective zipper pull tabs
- Locker loop, clip tabs on shoulders and convenient eyeglass tab
- Easy-access right chest radio pocket with mesh lining
- Snap-down media player pocket on left sleeve
- Dual side-entry pouch pocket with complete pass-through

88SS00 | NA | SM – 3XL | \$79.99



Fun Fact: Woven duck is a durable, heavy woven cotton fabric that's used for a number of common applications like tents or sandbags. Various weights are used for different applications.

Performance Cotton Pants with Reflective Piping

Featuring the same rugged durability as our popular Performance Cotton Tactical Pants, the Station Wear Pants with Reflective Piping are designed especially for fire/EMS professionals.

- Traditional fit
- Includes all standard pant features (see page 7)
- Constructed of durable 8.5 oz. 100% cotton canvas
- Generous, deep pockets for placement of knives, radios, tools, etc.
- Reinforced hems on leg cuffs and hand pockets for increased durability
- Double layering in seat for added wear and protection
- Integrated knee pad pockets (pads sold separately, see page 225)
- Reflective piping on outer seam

86TP04 | NA | 28" – 44" Even Waist, 30" – 36" Even Inseam; 46" – 48" Even Waist, 39" Unhemmed Inseam without Cuff Reinforcement | \$79.99





Women's Apparel

For years, women in the industry have struggled to find tactical apparel that actually fits, so we decided to do something about it. After countless hours of research and a whole a lot of TLC, we designed our first-ever BLACKHAWK!® women's apparel line. From duty and tactical to off-duty and athletic wear, each piece offers the same quality of our men's apparel but is uniquely tailored for the tactical woman.



Available colors: Khaki (KH), Black (BK), Olive Drab (OD), Navy (NA) and Chocolate Brown (CB)

Women's Lightweight Tactical Pants





These tactical pants are rugged, lightweight and provide "intelligent" storage options for the tactical woman. We didn't just shrink down our men's pants. We designed them for you!

- Includes all standard pant features (see page 7)
- Constructed of wrinkle-, fade- and stain-resistant 6.5 oz. polyester/cotton blend
- DWR (Durable Water Repellent) treatment resists stains and dries quickly
- Double layering in seat and knees for added wear and protection
- Easy-access, top-opening mag pouch on each leg

- Large top-opening cargo pockets with segmented 2" elastic webbing inside for intelligent storage of up to three mags, flashlights, knives or other items for quick access
- Vertical zippered storage pocket outside each cargo pocket for easy access while seated
- Large hidden zippered pocket behind right-hand pocket keeps valuable items secure but quickly accessible
- 550 cord loop on front waistband for attaching carabiners or other items
- Reinforced hems on leg cuffs and hand pockets for increased durability

92TP02 | KH, BK, OD, NA, CB | 26" – 40" Even Waist, 31" and 35" Inseam | \$64.99



-  Black (BK)
-  Khaki (KH)
-  Olive Drab (OD)
-  Navy (NA)
-  Chocolate Brown (CB)

Women's LT2 Tactical Pants NEW!

The Women's LT2 Tactical Pants are designed exclusively for the female operator, resulting in a stylish yet functional design with all the high-performance features you need in a pair of tactical pants.

- Includes all standard pant features (see page 7)
- Constructed of durable 6.5 oz. polyester/cotton ripstop
- DWR (Durable Water Repellent) treatment resists stains and dries quickly
- Double layering in knees for added wear and protection
- Internal knee pad pockets
- Two deep front and back pockets
- Large top-opening cargo pockets with segmented 2" elastic webbing inside for intelligent storage of up to three mags, flashlights, knives or other items for quick access

92TP03 | BK, KH, OD, NA, CB | 26" – 40" Even Waist, 31" and 35" Inseam | \$49.99

Women's Off Duty Pants

Perfect for concealed carry, undercover work or court day assignments, the casual Off Duty Pants have a low-key look but are built to perform.

- Constructed of 100% nylon
- DWR (Durable Water Repellent) treatment resists stains and dries quickly
- High-quality YKK® zippers and Prym® snaps
- Gusseted crotch for increased movement
- Silicone grip strip in waistband keeps shirt tucked in during extreme maneuvers
- Sturdy belt loops support holster and mags
- Fashionable midrise design helps with holster stability and alignment
- Double front pocket design for extra storage
- Covert, attractive rear pocket design

92NT02 | BK, KH | 26" – 40" Even Waist, 31" and 35" Inseam | \$64.99

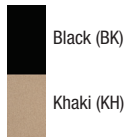

Did you know? To date, women make up about 13% of the law enforcement workforce in the United States.



Women's Lightweight Tactical Shirt

Designed for extreme performance in warm climates, the Women's Lightweight Tactical Shirt provides ample storage, functionality and comfort.

- Constructed of wrinkle-, fade- and stain-resistant 5.1 oz. polyester/cotton blend
- DWR (Durable Water Repellent) treatment resists stains and dries quickly
- Button-down tabs keep collar in place
- Sewn eyelets on yoke for ventilation
- Mesh pocket bags and back yoke panel for increased ventilation
- Reverse-pleat pockets expand when needed
- Right chest pocket with separate mesh compartments:
- One accessed by hidden zipper on vertical seam
- Catch pocket inside for cell phone in main pocket
- Left chest pocket with zippered hidden pocket and sunglasses loop
- Hidden pocket under beltline for additional storage options
- Gussets under arms for uninhibited range of motion
- Roll-up sleeves with internal button fasteners (Long Sleeve only, 92TS01)

Long Sleeve | 92TS01 | BK, KH, OD, NA, CB | SM – 2XL | \$59.99
Short Sleeve | 92TS02 | BK, KH, OD, NA, CB | SM – 2XL | \$56.99



Women's LT2 Tactical Shirt NEW!

Featuring multiple storage compartments and lightweight, water-repellent construction, this utilitarian shirt is specifically tailored to fit the female body, giving you the style, comfort and function you deserve.

- Constructed of durable 5.1 oz. polyester/cotton ripstop
- DWR (Durable Water Repellent) treatment resists stains and dries quickly
- Concealed collar-stay buttons and anti-roll collar inserts
- Set-in sleeves with gusseted underarms for full range of motion
- Snap-down media player pocket on left sleeve with button hole for cord routing
- Two front patch pockets
- Elastic cord loop on pocket flap to hang sunglasses, pens, etc.

Long Sleeve | 92TS03 | BK, KH, OD, NA, CB | SM - 2XL | \$49.99
 Short Sleeve | 92TS04 | BK, KH, OD, NA, CB | SM - 2XL | \$49.99

Women's Strenia Top

Constructed of a durable, wrinkle-resistant polyester blend, the easy-care Strenia Top provides lightweight comfort while on or off duty and is designed to help conceal a weapon without tenting.

- Constructed of wrinkle-resistant, moisture-wicking polyester blend
- Engineered cut provides concealment without tenting
- Quick-dry and SPF sun protection treatments
- Pleated, ventilated back yoke for ease of motion and ventilation
- Hidden zippered pockets at waist on both sides for quick access
- Low side slits for easy pant-pocket and belt access

92CC0 | BG, GW, WN | SM - 2XL | \$49.99



Burgundy (BG)

Gray/White (GW)

White/Navy (WN)

Strenia was the Roman goddess of strength and endurance.





Women's Long Sleeve Strenia Top NEW!

Made with moisture-wicking and wrinkle-resistant treatments, the breathable Long Sleeve Strenia Top is the perfect casual performance shirt for your days off.

- Relaxed fit
- Constructed of lightweight, durable, quick-dry polyester/nylon or polyester/rayon blends
- Wrinkle-resistant, moisture-wicking
- Hidden zippered pockets on side seams
- Mesh back vents for breathability
- Low side slits for easy pant pocket and belt access
- Available in Rose/Red (RR), Burnt Orange/Orange (OR), Navy/Gray (NG) and Green/White (GW)

92CC04-LS | RR, OR, NG, GW | SM - 2XL | \$49.99



Women's Performance Polo

Work hard or play hard in the Women's Performance Polo! Its unique nylon blend wicks moisture and feels cool in almost any environment.

- Modern fit with cap sleeves
- Constructed of lightweight proprietary 90% nylon blend with moisture-wicking treatment
- Provides sun protection factor of 30 (SPF 30)
- Pique knitted back collar for comfort and increased airflow at back neck
- Collar with anti-roll inserts
- Three-button placket
- Hanging loop at bottom of placket to hang sunglasses, pens, etc.

92PP02 | BO, BK, NA, RR, PB, WH | SM - 2XL | \$49.99



Available colors: Burnt Orange (BO), Black (BK), Navy (NA), Range Red (RR), Periwinkle Blue (PB) and White (WH)

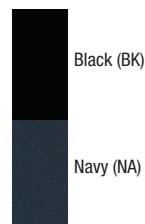

Women's Compression Bra

Built for the gym or trail, the Compression Bra provides support and breathability even when worn as a base layer. Strategically placed mesh panels on the front and back deliver maximum airflow, keeping you cool and dry.

- Constructed of polyester/spandex blend fabric
- Built for moderate impact activity
- Antimicrobial technology prevents growth of odor-causing microbes
- Snug compression fit
- Moisture-transport system wicks sweat and regulates core temperature
- Soft double-layer fabric is smooth against skin
- Classic mesh racer back for enhanced range of motion and airflow
- Plush elastic band for added comfort and support

92CB02 | BK, NA | SM – 2XL | \$39.99

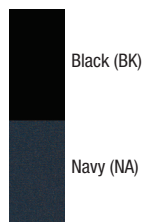

Women's Compression Shorts

The Compression Shorts are constructed of a polyester/spandex blend fabric with moisture-wicking and antimicrobial treatments—perfect for the gym, trail or as a base layer.

- Constructed of 80% polyester/20% spandex
- Snug second-skin compression fit with a wide midrise waistband
- Lightweight power-stretch construction for ultimate maneuverability
- Moisture-wicking treatment keeps you cool and dry
- Antimicrobial technology prevents growth of odor-causing microbes
- Flat seams for comfort and easy layering
- Gusseted crotch for increased movement
- 7-inch inseam

92CS02 | BK, NA | SM – 2XL | \$29.99





Women's Technical V-Neck

We know how hard you work to stay in shape for your job and for your health. So gear up for a workout or a day on the trail with the high-performance Technical V-Neck!

- Polyester blend with moisture-wicking treatment keeps you cool and dry
- Antimicrobial technology prevents growth of odor-causing microbes
- Tagless label at neck for increased comfort
- Cap sleeves provide excellent range of motion

92TT02 | BK, WH, HB | SM – 2XL | \$36.99

Available colors: Black (BK), White (WH) and Heather Blue (HB)



X-Ray view

Women's CCW Tech Hoodie NEW!

When it comes to carrying concealed, nothing says “discreet” like the everyday hoodie. We’ve taken this ever-popular design and given it a modern twist, incorporating a handgun access point in the hand-warmer pocket for your belt-mounted holster.

- Constructed of 100% polyester fleece (BK, NA) or polyester blend (GH)
- Access point behind front pocket for easy access to belt holster
- Hidden pocket on front pouch pocket
- Drawstring-adjustable hood for comfortable fit
- Clear resin print on elbows for added durability
- Drop shoulder seams for better fit

92FH00 | BK, NA, GH | SM – 2XL | \$49.99



Women's Waterproof Jacket NEW!

Designed to give you outstanding coverage and weather protection, the Waterproof Jacket features a zip-in hood that can be stowed neatly inside the jacket to prevent bulk in the collar.

- Constructed of 100% polyester three-layer fabric plus additional 2.5-layer waterproof, breathable fabrics
- Adjustable waist for comfortable fit
- Front storm flaps keep water out
- Adjustable hood zips into back collar and snaps into front collar (right and left side)
- Zippered side seams for ventilation
- Contoured cuffs with VELCRO® straps for adjustable fit
- Accommodates BLACKHAWK!™ Women's WR Quilted Jacket (sold separately, see page 36) via snap-in connection points
- Available in Black (BK), Navy (NA), Burgundy (BG) and Green (GN)

92WJ01 | BK, NA, BG, GN | SM – 2XL | \$299.99



Women's WR Quilted Jacket NEW!

Designed to keep you warm during colder months, this quilted jacket is perfectly shaped for the female figure. Wear it alone as a water-repellent barrier or snap it into our Women's Waterproof Jacket for a little extra warmth.

- Constructed of water-repellent 100% nylon shell with 100% polyester fleece underarms
- Recycled content
- Front storm flaps keep water out
- Front zipper garage protects neck/chin from zipper head
- Dropped tail for additional coverage
- Side back seams with discreet pockets
- Drop shoulder seams for better fit
- Can be integrated into BLACKHAWK!™ Women's Waterproof Jacket (sold separately, see page 35) via snap-in connection points
- Available in Black (BK), Navy (NA), Burgundy (BG) and Green (GN)

92WJ00 | BK, NA, BG, GN | SM – 2XL | \$109.99



Bold Graphic T-Shirt (92GT01)



Strenia Graphic T-Shirt (92GT00)

Women's Graphic T-Shirts NEW!

Designed to complement the female form, these modern Graphic T-Shirts with short sleeves are a great choice for your days off.

- Constructed of 100% cotton (BK, WH) or cotton blend (HG)
- Modern graphics
- Short sleeves
- Bold Graphic T-Shirts (92GT01) available in Black (BK) with "Strong" graphic, Heather Gray (HG) with "Driven" graphic and White (WH) with "Bold" graphic
- Strenia Graphic T-Shirts (92GT00) available in Black (BK), Heather Gray (HG) and White (WH)

Bold Graphic T-Shirt | 92GT01 | BK, HG, WH | SM – 2XL | \$14.99

Strenia Graphic T-Shirt | 92GT00 | BK, HG, WH | SM – 2XL | \$14.99



Women's Crest Hoodie NEW!

This traditional-fit 100% cotton hoodie lets you rock the BLACKHAWK!® logo in style while giving you all the comfort of a casual hoodie.

92GH00 | BK, HG, WH | SM – 2XL | \$39.99

- Constructed of 100% cotton (BK, WH) or cotton blend (HG)
- Long sleeves
- Traditional-fit design
- Front pockets
- Available in Black (BK), Heather Gray (HG) and White (WH)



Performance Fleece Watch Cap

Keep the chill out and the warmth in with this low-profile fleece watch cap!

- Constructed of soft polyester fleece
- Low-profile design fits easily under helmets
- Accessory pocket with YKK® zipper securely holds iPod® or other small items
- Buttonhole underneath pocket for convenient cord routing
- Wear inside out to avoid seam irritation when wearing a helmet
- One size fits all

808001 | BK, OD, CT | \$14.99

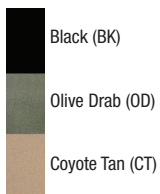

ECW Low-Profile Watch Cap

Featuring plush fleece construction, this sleek watch cap offers substantial warmth without the itching and irritation associated with wool or poly/cotton caps.

- Constructed of 100% 7 oz. Blizzard Fleece™
- Low-profile design fits easily under helmets and hoods
- Wear inside out to avoid seam irritation when wearing a helmet

808000 | BK, OD, CT | \$21.99



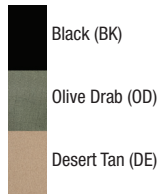

Low-Profile Logo Cap

- Low-profile design
- Adjustable strap fits wide range of sizes
- Structured bill
- BLACKHAWK!® logo design

90BC09 | BK, OD, DE | \$19.99

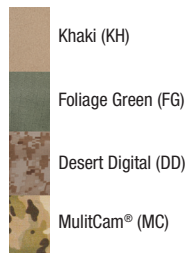

Contractor Cap

The Contractor Cap is designed to comply with the U.S. Department of State mandate on clothing for contractors working abroad.

- Loop patches on front, back and top to attach flag, name badge or glint tape
- Adjustable hook & loop strap

90BC10 | KH, FG, DD, MC | \$14.99
(MC = \$24.99)



Advanced Boonie Hat

Keep your head protected from the sun and rain with the Advanced Boonie Hat. Choose between Desert Digital and MultiCam® patterns to wear in conjunction with our HPFU™ uniforms (sold separately, see page 4 – 5).

- Lightweight and crushable
- Flat top with floppy brim
- Soft mesh side vents, crown lining and hidden mesh map pockets
- Square VELCRO® loop on crown for attaching badges
- Self-fabric side band loops
- Drawstring with cordlock at back can be used as chin strap and cinching cord

90AB00 | DD | 7 – 8 | \$19.99
90AB00 | MC | 7 – 8 | \$24.99

To find your correct size, measure around your head where your hat normally sits and follow these guidelines:

Circumference:	22"	22.75"	23.5"	24.25"	25"
Hat Size:	7	7.25	7.5	7.75	8

Technology

Our mission at BLACKHAWK!® is to design the most reliable carriers, soft armor, plates and accessories to help improve operator efficiency, confidence and mission completion. Whether worn alone or dovetailed with any of our other tactical gear, each piece in our armor line provides all-around protection and versatility to suit every warrior's needs. Choose between two manufacturing options: Berry Amendment Compliant (BAC) or Commercial off the Shelf (COTS).

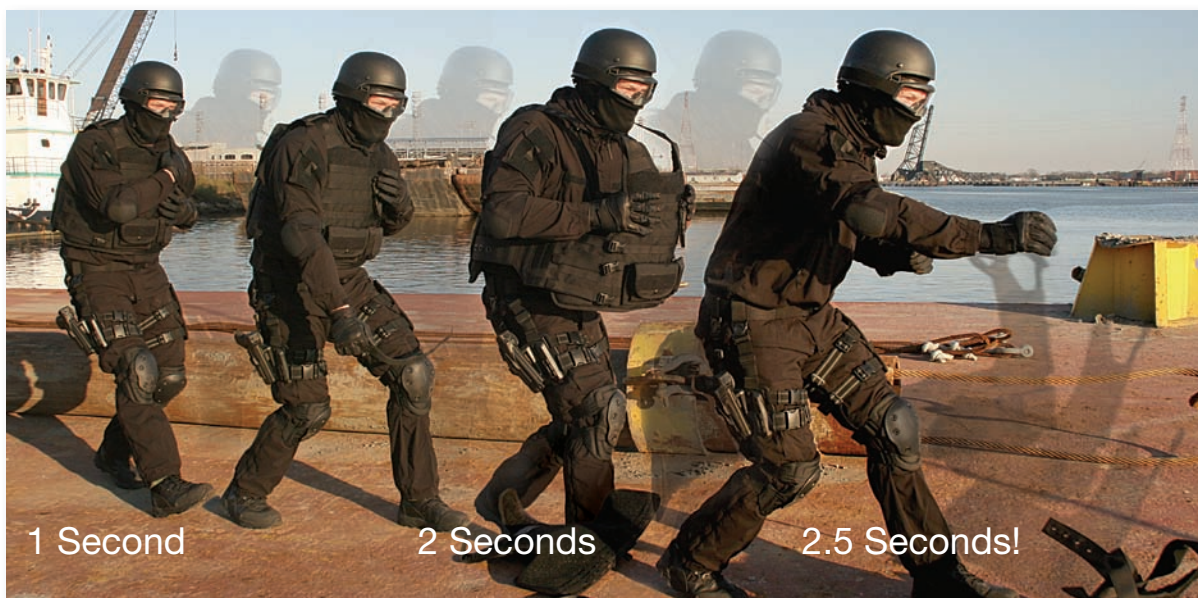

S.T.R.I.K.E.® Cutaway Tactical Armor Carrier with quick-release system (see page 40)

Armor Carriers

S.T.R.I.K.E.® Cutaway Tactical Armor Carrier with 3-D Mesh Lining

Weighing in at only 3.5 lbs., this innovative carrier is our lightest cutaway yet. Remove the carrier in approximately 2.5 seconds and then reassemble it again in less than one minute thanks to a straightforward design and quick-release system.

- Internal 3-D mesh lining for positive airflow around torso and comfortable wear
- Constructed of 500 denier CORDURA® nylon (BAC and COTS MultiCam®), 500 denier CORDURA® nylon (BAC solid colors) or 500 denier ripstop nylon (COTS solid colors)
- Front shoulder panel with quick-release strap and rounded handle under protective nylon band
- Heavy-duty drag handle
- Non-slip material on shoulders for weapon retention
- Adjustable waist and shoulder system for tailored girth and torso fit
- Multiple rows of S.T.R.I.K.E.® webbing for attaching pouches, holsters or accessories
- Accommodates BLACKHAWK!® Level IIIA Soft Armor (sold separately, see page 42) and Ballistic Ceramic Plates (sold separately, see page 47)
- Accommodates BLACKHAWK!® Removable Side Plate Carrier and Ballistic Collar, Yoke, Biceps, Groin and Drop Leg (sold separately, see page 47)
- U.S. and foreign patents pending
- See Armor Bundles on page 42 for carrier/soft armor bundles

BAC | 32V6 | BK, CT, MC | SM - XL | \$399.99 (MC = \$459.99)
 COTS | 32V6-CTS | BK, CT, OD, MC | XS - XL | \$299.99 (MC = \$367.99)



Does not include side plate pouches

S.T.R.I.K.E.® Cutaway Tactical Armor Carrier with Nylon Lining

Built with unyielding materials and featuring a convenient cutaway system, this lightweight 3.5-lb. carrier is designed with the tactical operator in mind. Remove the carrier in approximately 2.5 seconds and then reassemble it again in less than one minute thanks to a straightforward design and quick-release system.

- Internal nylon lining for sleek profile and comfortable wear
- Constructed of 500 denier CORDURA® nylon (BAC and COTS MultiCam®), 500 denier CORDURA® nylon (BAC solid colors) or 500 denier ripstop nylon (COTS solid colors)
- Front shoulder panel with quick-release strap and rounded handle under protective nylon band
- Heavy-duty drag handle
- Non-slip material on shoulders for weapon retention
- Adjustable waist and shoulder system for tailored girth and torso fit
- Multiple rows of S.T.R.I.K.E.® webbing for attaching pouches, holsters or accessories
- Accommodates BLACKHAWK!® Level IIIA Soft Armor (sold separately, see page 42) and Ballistic Ceramic Plates (sold separately, see page 47)
- Accommodates BLACKHAWK!® Removable Side Plate Carrier and Ballistic Collar, Yoke, Biceps, Groin and Drop Leg (sold separately, see page 47)
- U.S. and foreign patents pending
- See Armor Bundles on page 42 for carrier/soft armor bundles

BAC | 32V4 | BK, CT, MC | SM - XL | \$379.99 (MC = \$439.99)
 COTS | 32V4-CTS | BK, CT, OD, MC | XS - XL | \$279.99 (MC = \$359.99)



S.T.R.I.K.E.® Non-Cutaway Tactical Armor Carrier

This non-cutaway tactical carrier is constructed of lightweight yet rugged materials and weighs in at only 2.5 lbs. The full exterior features heavy-duty S.T.R.I.K.E. webbing, giving you plenty of options for modular pouch or accessory attachment.

- Does not include quick-release cutaway system
- Constructed of 500 denier CORDURA® nylon (BAC and COTS MultiCam®), 500 denier CORDURA® nylon (BAC solid colors) or 500 denier ripstop nylon (COTS solid colors)
- Heavy-duty drag handle
- Non-slip material on shoulders for weapon retention
- Adjustable waist and shoulder system for tailored girth and torso fit
- Multiple rows of S.T.R.I.K.E.® webbing for attaching pouches, holsters or accessories
- Accommodates BLACKHAWK!® Level IIIA Soft Armor (sold separately, see page 42) and Ballistic Ceramic Plates (sold separately, see page 47)
- Accommodates BLACKHAWK!® Removable Side Plate Carrier and Ballistic Collar, Yoke, Biceps, Groin and Drop Leg (sold separately, see page 47)
- See Armor Bundles on page 47 for carrier/soft armor bundles

BAC | 32V5 | BK, CT, MC | SM - XL | \$299.99 (MC = \$349.99)

COTS | 32V5-CTS | BK, CT, OD, MC | XS - XL | \$219.99 (MC = \$286.99)



Looking for the right size? Use the following BLACKHAWK!® carrier minimum/maximum girth measurements as a reference: XS = 33" - 38", SM = 40" - 50", MD = 42" - 56", LG = 44" - 62" and XL = 46" - 68".



Front



Front adjustment



Back



Back adjustment



Back



Side

Does not include side plate pouches

Armor Bundles

Our BLACKHAWK!® armor bundles let you choose between two proven soft armor options: Elite Level IIIA Special Threat Soft Armor or V.I.P. Level IIIA Special Threat Soft Armor. Then pair your soft armor with one of our durable armor carriers: S.T.R.I.K.E.® Cutaway Tactical Armor Carrier with 3-D Mesh Lining, S.T.R.I.K.E.® Cutaway Tactical Armor Carrier with Nylon Lining or S.T.R.I.K.E.® Non-Cutaway Tactical Armor Carrier (see page 40 – 41 for product descriptions).

Get 10% more surface area coverage than concealment armor with our Elite and V.I.P. soft armor!



Elite Level IIIA Special Threat Armor Bundle (ST3A4)

Elite Level IIIA Special Threat Soft Armor

- Model: C32SP13 ELITE NIJ 06 (ST3A4)
- Description: Ballistic Level IIIA Soft Armor
- Panel cover: 200 denier nylon coated with polyurethane encapsulation fabric sonically welded sealed to be waterproof
- Ballistic materials: Twaron® and Dyneema®
- Thinness: .27"
- Areal density: 1.18 lbs./sq. ft.

Test Results:

- Dry v50 – 357sig 125gr TMJ: 1913 ft/s (583 m/s)
- Dry v50 – 357sig 125gr TMJ: 1789 ft/s (545 m/s)
- Cond. v50 – 357sig 125gr TMJ: 1839 ft/s (561 m/s)
- Dry v50 – 44mag 240gr JHP: 1786 ft/s (544 m/s)
- Dry v50 – 44mag 240gr JHP: 1675 ft/s (511 m/s)
- Cond. v50 – 44mag 240gr JHP: 1853 ft/s (565 m/s)
- Wet P-BFS Average, 357sig 125gr TMJ: 28.5mm
- Wet P-BFS Average, 44mag 240gr JHP: 36.3 mm
- Special threat rounds: Winchester 9mm 127 grain SXT, FN 5.7 x 28 (SS195)
- NIJ compliance: All vests are certified in accordance with the requirements for the NIJ standard 0101.06

With S.T.R.I.K.E.® Cutaway Tactical Armor Carrier with 3-D Mesh Lining

BAC | 32BV -ST3A4 | BK, CT, MC | XS - XL | \$2299.99 (MC = \$2349.99)
COTS | 32BV -ST3A4C | BK, CT, OD, MC | XS - XL | \$2199.99 (MC = \$2249.99)

With S.T.R.I.K.E.® Cutaway Tactical Armor Carrier with Nylon Lining

BAC | 32B4 -ST3A4 | BK, CT, MC | XS - XL | \$2249.99 (MC = \$2299.99)
COTS | 32B4 -ST3A4C | BK, CT, OD, MC | XS - XL | \$2149.99 (MC = \$2199.99)

With S.T.R.I.K.E.® Non-Cutaway Tactical Armor Carrier

BAC | 32B5 -ST3A4 | BK, CT, MC | XS - XL | \$2199.99 (MC = \$2249.99)
COTS | 32B5 -ST3A4C | BK, CT, OD, MC | XS - XL | \$2119.99 (MC = \$2169.99)

V.I.P. Level IIIA Special Threat Armor Bundle (ST3A5)

V.I.P. Level IIIA Special Threat Soft Armor

- Model: C32SP14 ELITE NIJ 06 (ST3A5)
- Description: Ballistic Level IIIA Soft Armor
- Panel cover: 200 denier nylon coated with polyurethane encapsulation fabric sonically welded sealed to be waterproof
- Ballistic materials: Twaron® and KEVLAR®
- Thinness: .33"
- Areal density: 1.5 lbs./sq. ft.

Test Results:

- Dry v50 – 357sig 125gr TMJ: 1776 ft/s (541 m/s)
- Dry v50 – 357sig 125gr TMJ: 1705 ft/s (520 m/s)
- Cond. v50 – 357sig 125gr TMJ: 1784 ft/s (544 m/s)
- Dry v50 – 44mag 240gr JHP: 1610 ft/s (491 m/s)
- Dry v50 – 44mag 240gr JHP: 1545 ft/s (471 m/s)
- Cond. v50 – 44mag 240gr JHP: 1672 ft/s (510 m/s)
- Wet P-BFS Average, 357sig 125gr TMJ: 29.6mm
- Wet P-BFS Average, 44mag 240gr JHP: 37.7 mm
- NIJ compliance: All vests are certified in accordance with the requirements for the NIJ standard 0101.06

With S.T.R.I.K.E.® Cutaway Tactical Armor Carrier with 3-D Mesh Lining

BAC | 32BV -ST3A5 | BK, CT, MC | XS - XL | \$1299.99 (MC = \$1329.99)
COTS | 32BV -ST3A5C | BK, CT, OD, MC | XS - XL | \$1199.99 (MC = \$1229.99)

With S.T.R.I.K.E.® Cutaway Tactical Armor Carrier with Nylon Lining

BAC | 32B4 -ST3A5 | BK, CT, MC | XS - XL | \$1249.99 (MC = \$1279.99)
COTS | 32B4 -ST3A5C | BK, CT, OD, MC | XS - XL | \$1149.99 (MC = \$1179.99)

With S.T.R.I.K.E.® Non-Cutaway Tactical Armor Carrier

BAC | 32B5 -ST3A5 | BK, CT, MC | XS - XL | \$1199.99 (MC = \$1229.99)
COTS | 32B5 -ST3A5C | BK, CT, OD, MC | XS - XL | \$1119.99 (MC = \$1149.99)

Plate Carriers

S.T.R.I.K.E.® Cutaway Plate Carrier

- Simple construction for quick attachment and detachment (cutaway function can be easily disabled if desired)
- Lightest cutaway plate carrier available (only 3.2 lbs.)
- Constructed of 500 denier CORDURA® nylon (MultiCam®) or 500 denier ripstop nylon (solid colors)
- Front shoulder panel with quick-release strap and rounded handle under protective nylon band
- Heavy-duty drag handle
- Adjustable waist and shoulder system for tailored girth and torso fit
- Multiple rows of S.T.R.I.K.E.® webbing for attaching pouches, holsters or accessories
- Front plate pocket with inverted “T” elastic keeper accommodates bib when plates are not in use
- Ambidextrous design
- Accommodates BLACKHAWK!® Ballistic Ceramic Plates (sold separately, see page 47) in fully adjustable front/rear pockets and removable side plate pouches



Full front



Back



Adjustable side panels for girth

32V701 | BK, CT, OD AU, MC | \$249.99
(MC = \$279.99)

Capable of torso length adjustments

Low Vis Plate Carrier

- Lightweight, close-fitting design
- Constructed of 500 denier CORDURA® nylon (MultiCam®) or 500 denier ripstop nylon (solid colors)
- Slim enough to be worn under clothes for low visibility
- Adjustable shoulder and side straps (one size fits all)
- Side-release buckles for quick donning and doffing
- Front hook & loop panel for ID patch
- 32PC08 model accommodates BLACKHAWK!® Ballistic Ceramic Plates up to 9.5" x 12.5" (sold separately, see page 47)
- 32PC12 model accommodates BLACKHAWK!® Ballistic Ceramic Plates up to 10.5" x 13.25" (sold separately, see page 47)

9.5" x 12.5" | 32PC08 | BK, CT, OD, MC | \$49.99 (MC = \$71.99)
10.5" x 13.25" | 32PC12 | BK, CT, OD, MC | \$49.99 (MC = \$71.99)



Removable Side Plate Carrier (Pair)

- Constructed of 500 denier CORDURA® nylon (BAC and COTS MultiCam®), 500 denier CORDURA® nylon (BAC solid colors) or 500 denier ripstop nylon (COTS solid colors)
- Accommodates BLACKHAWK!® Ballistic Ceramic Side Plates up to 6" x 8" (sold separately, see page 47)
- Attaches to front and rear of PALS/MOLLE platform with side-release buckles
- Removable straps for attachment to S.T.R.I.K.E.® platform with Speed Clips™ (sold separately, see page 214)



BAC | 32AC08 | BK, CT, MC | \$79.99 (MC = \$84.99)

COTS | 32AC08-CTS | BK, CT, OD, MC | \$49.99 (MC = \$59.99)

S.T.R.I.K.E.® Commando Recon Chest Harness

- Cross-back design
- Shoulder straps with closed-cell foam padding
- Heavy-duty D-rings and elastic webbing loops for securing external items
- Multiple rows of S.T.R.I.K.E.® webbing for attaching pouches, holsters or accessories
- Front plate pocket with inverted "T" elastic keeper accommodates bib when plates are not in use
- Accommodates BLACKHAWK!® Ballistic Ceramic Plates up to 10.5" x 13.25" (sold separately, see page 47)
- Regular model accommodates S.T.R.I.K.E.® Commando Recon Back Panel (sold separately, see page 45) for full torso rig
- Husky model is not compatible with S.T.R.I.K.E.® Commando Recon Back Panel or S.T.R.I.K.E.® Lightweight Commando Recon Back Panel (see page 45)
- Dimensions (Regular): 24" x 9" (body), 9" x 7" (bib), 69" (girth)
- Dimensions (Husky): 24" x 11" (body), 14" x 7" (bib), 69" (girth)
- Weight (Regular): 2.1 lbs.
- Weight (Husky): 2.5 lbs.



Regular | 37CL01 | BK, CT, MC | \$129.99 (MC = \$144.99)

Husky | 37CL01-H | BK | \$133.99 **WHILE SUPPLIES LAST**

S.T.R.I.K.E.® Lightweight Commando Recon Chest Harness

- Cross-back design
- Sleek, lightweight design is 40% lighter than S.T.R.I.K.E.® Commando Recon Chest Harness
- Constructed of 500 denier CORDURA® nylon (MultiCam®) or 500 denier ripstop nylon (solid colors)
- Shoulder straps with closed-cell foam padding
- Heavy-duty D-rings and elastic webbing loops for securing external items
- Multiple rows of S.T.R.I.K.E.® webbing for attaching pouches, holsters or accessories
- Front plate pocket with inverted "T" elastic keeper accommodates bib when plates are not in use
- Accommodates S.T.R.I.K.E.® Commando Recon Back Panel (sold separately, see page 45) for full torso rig
- Accommodates BLACKHAWK!® Ballistic Ceramic Plates up to 10.5" x 13.25" (sold separately, see page 47)
- Dimensions: 23" x 8" (body)
- Weight: 1.52 lbs.



The S.T.R.I.K.E.® Lightweight Commando Recon Chest Harness is 40% lighter than our S.T.R.I.K.E.® Commando Recon Chest Harness!

37CL82 | BK, CT, MC | \$129.99 (MC = \$139.99)

S.T.R.I.K.E.® Commando Recon Back Panel

- Heavy-duty drag handle
- IVS™ (Intercooler Venting System) back panel for ventilation
- Large grommeted bottom flap with hook & loop to hold ballistic plates
- Compatible with S.T.R.I.K.E.® Commando Recon Chest Harness (sold separately, see page 44) for full torso rig
- Accommodates BLACKHAWK!® Ballistic Ceramic Plates up to 10.5" x 13.25" (sold separately, see page 47)
- Includes shoulder strap
- Weight: 1.45 lbs.



Front view

37CL41 | BK, CT, OD, AU, MC | \$74.99 (MC = \$89.99)

S.T.R.I.K.E.® Lightweight Commando Recon Back Panel

- Constructed of 500 denier CORDURA® nylon (MultiCam®) or 500 denier ripstop nylon (solid colors)
- Heavy-duty drag handle
- Dual-adjust side-release buckles for fit adjustment
- Multiple rows of S.T.R.I.K.E.® webbing for attaching pouches, holsters or accessories
- Compatible with S.T.R.I.K.E.® Commando Recon Chest Harness (sold separately, see page 44) or S.T.R.I.K.E.® Enhanced Commando Recon Harness (sold separately, see below) for full torso rig
- SM/MD version accommodates BLACKHAWK!® Ballistic Ceramic Plates up to 9.5" x 12.5" (sold separately, see page 47)
- LG/XL version accommodates BLACKHAWK!® Ballistic Ceramic Plates up to 10.5" x 13.25" (sold separately, see page 47)
- Weight (SM/MD): 12 oz.
- Weight (LG/XL): 14 oz.



SM/MD | 37CL85 | BK, CT, MC | \$64.99 (MC = \$79.99)

LG/XL | 37CL86 | BK, CT, MC | \$64.99 (MC = \$79.99)

S.T.R.I.K.E.® Enhanced Commando Recon Harness

- Zipper on top edge of cummerbund for internal storage
- Multiple rows of internal/external S.T.R.I.K.E.® webbing for attaching pouches, holsters or accessories
- Magazine pockets on front with quick-release tabs and dividers for up to eight M16/M4 magazines
- Single plate pocket with inverted "T" elastic keeper for tri-curve plate
- Front plate pocket with inverted "T" elastic keeper accommodates bib when plates are not in use
- Accommodates BLACKHAWK!® Ballistic Ceramic Plates up to 10.5" x 13.25" (sold separately, see page 47)

37CL78 | BK, CT, OD, AU, MC | \$149.99 (MC = \$169.99)





Front



Back

S.T.R.I.K.E.® Plate Carrier Harness

- Heavy-duty drag handle
- IVS™ (Intercooler Venting System) back panel for ventilation
- Large hook & loop flap on front and back to hold ballistic plates
- Multiple rows of S.T.R.I.K.E.® webbing for attaching pouches, holsters or accessories
- Accommodates BLACKHAWK!® Ballistic Ceramic Plates up to 10.5" x 13.25" (sold separately, see page 47)
- Dimensions: 14"W x 13"H (front), 14"W x 16"H (back)
- Weight: 2.1 lbs.

37CL33 | BK, CT, AU, MC | \$149.99 (MC = \$159.99)



Front



Back

S.T.R.I.K.E.® Lightweight Plate Carrier Harness

- Constructed of 500 denier CORDURA® nylon (MultiCam®) or 500 denier ripstop nylon (solid colors)
- Multiple rows of S.T.R.I.K.E.® webbing for attaching pouches, holsters or accessories
- Heavy-duty drag handle
- Dual-adjust side-release buckles for fit adjustment
- SM/MD version accommodates BLACKHAWK!® Ballistic Ceramic Plates up to 9.5" x 12.5" (sold separately, see page 47)
- LG/XL version accommodates BLACKHAWK!® Ballistic Ceramic Plates up to 10.5" x 13.25" (sold separately, see page 47)
- Weight (SM/MD): 1.3 lbs.
- Weight (LG/XL): 1.5 lbs.

SM/MD | 37CL83 | BK, CT, MC | \$149.99 (MC = \$159.99)

LG/XL | 37CL84 | BK, CT, MC | \$149.99 (MC = \$159.99)



Protects exposed sides

S.T.R.I.K.E.® Rapid Mobile Plate Carrier **WHILE SUPPLIES LAST**

- Protects exposed sides between front and rear ballistic plates when worn with standard vest
- Can be configured for over-the-shoulder or front/back wear
- Fully adjustable shoulder strap and waist strap for stability
- Side-release buckles for quick donning and doffing
- Multiple rows of S.T.R.I.K.E.® webbing for attaching pouches, holsters or accessories
- Accommodates BLACKHAWK!® Ballistic Ceramic Plates (sold separately, see page 47)
- Options:
 - Keep on seat or in trunk of patrol car for first response scenarios
 - Double over the shoulder for both exposed sides (turret gunners)
 - Over the neck for frontal protection
 - Daisy-chained (two carriers, front/back) over the neck for quick vest dismount
 - Dismounted for cover behind plate (sniper hide position, etc.)

37CL71 | CT, AU | \$51.99

Armor Accessories



Ballistic Collar with V.I.P. Level IIIA Soft Armor

BAC | 32BA01 -ST3A5 | BK, CT, MC | \$134.99
(MC = \$139.99)
COTS | 32BA01 -ST3A5C | BK, CT, OD, MC |
\$129.99 (MC = \$134.99)



Ballistic Yoke with V.I.P. Level IIIA Soft Armor

BAC | 32BA06 -ST3A5 | BK, CT, MC | \$134.99
(MC = \$139.99)
COTS | 32BA06 -ST3A5C | BK, CT, OD, MC |
\$129.99 (MC = \$134.99)



Ballistic Biceps (Set) with V.I.P. Level IIIA Soft Armor

BAC | 32BA04 -ST3A5 | BK, CT, MC |
\$323.99 (MC = \$332.99)
COTS | 32BA04 -ST3A5C | BK, CT, OD, MC |
\$299.99 (MC = \$314.99)



Ballistic Groin Protector with V.I.P. Level IIIA Soft Armor

BAC | 32BA03 -ST3A5 | BK, CT, MC | \$186.99
(MC = \$193.99)
COTS | 32BA03 -ST3A5C | BK, CT, OD, MC |
\$179.99 (MC = \$188.99)



Ballistic Drop Leg with V.I.P. Level IIIA Soft Armor

BAC | 32BA02 -ST3A5 | BK, CT, MC | \$169.99
(MC = \$174.99)
COTS | 32BA02 -ST3A5C | BK, CT, OD, MC |
\$149.99 (MC = \$155.99)

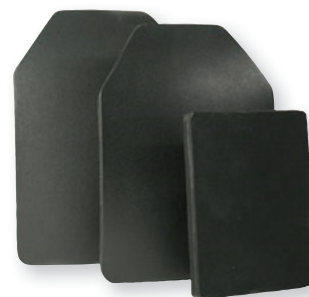

Certified to NIJ0101.04 & 5 standards

Level IV Standalone Ballistic Ceramic Side Plate (6" x 8")

- Single-curve armor vest insert plate
- Weight: 3.3 lbs.
- Thickness: 17 mm

32HP02BK-GSA | BK | \$299.99

Level IV Standalone Ballistic Ceramic Plate (9.5" x 12.5")

- Multi-curve armor vest insert plate
- Weight: 7.2 lbs.
- Thickness: 17 mm

32HP08BK-GSA | BK | \$499.99

Level IV Standalone Ballistic Ceramic Plate (10.5" x 13.25")

- Multi-curve armor vest insert plate
- Weight: 8.3 lbs.
- Thickness: 17 mm

32HP12BK-GSA | BK | \$599.99

All COTS Olive Drab ballistic accessories are custom order only, so please allow for six week lead time.



Ballistic Level IIIA MICH Helmet

Based on the original Special Forces MICH, the Ballistic Level IIIA MICH Helmet maintains a large coverage area while providing superior comfort. Plus, the four-point, padded suspension system doesn't require aftermarket pads.

- Constructed of plain-weave aramid in high-tensile elongation resin
- Coated with epoxy and polyurethane shell
- Improved operator's cut to enhance hearing and vision
- Fully adjustable to fit a variety of head sizes
- Two-way adjustable rear support and adjustable chin strap
- Adjustable crown and temple tension
- Comfortable head harness is fully adjustable and insulated
- Quick-release system
- Works well with A.C.E. Tactical Goggles (sold separately, see page 224)
- Weight: 2.7 lbs.

Test Results:

- Successfully completed H.P. White Laboratory Test Procedure HPW-TP-0401.01B for ballistic performance and tested to MIL-STD 662F for fragmentation performance
- V50 w/9mm performance at over 1400 fps
- V50 w/17 grain FSP MIL-STD frag round at over 2300 fps

Small | 32BH01BK-SM-GSA | BK | \$599.99

Medium | 32BH01BK-MD-GSA | BK | \$599.99

Large | 32BH01BK-LG-GSA | BK | \$599.99

XLarge | 32BH01BK-XL-GSA | BK | \$599.99

Head Size	Circumference	Diameter
Small	19" – 22" (49 – 56 cm)	5.5" – 6.5"
Medium	21" – 23" (54 – 59 cm)	6.5" – 7.25"
Large	22" – 25" (57 – 64 cm)	7" – 8"
XLarge	24" – 26" (61 – 66 cm)	7.5" – 8.5"



Helmet Cover

- Constructed of nylon/cotton ripstop material and is NIR compliant
- Close-fitting design for MICH-style helmets
- Built to MIL-spec standards
- Designed to mount with padded suspension systems
- Glint-tape mounting locations and covers
- Rear hook & loop flap

Small/Medium | 32HC01AU-S/M | AU | \$19.99

Large | 32HC01AU-LG | AU | \$19.99

XLarge | 32HC01AU-XL | AU | \$19.99

Diversi^on™ Line

Our new Diversi^on bags and packs go beyond "discreet" or "concealed" by mimicking everyday gym bags, sports equipment bags or backpacks. Transport and store firearms conveniently without drawing attention thanks to hidden, easy-access compartments and common color schemes that help you blend in with the world around you.

Available Colors:

Gray/Black (GYBK), Black/Red (BKRD), Gray/Blue (GYBL), Gray/Red (GYRD), Ranger Green/Coyote Tan (RGCT)



Diversi^on™ Racquet Bag **NEW!**

Take concealment to a whole new level with the Diversi^on Racquet Bag. Featuring padded walls with an inner shell, this clever bag mimics an ordinary tennis racket case but allows you to keep firearms protected and out of sight.

- Constructed of 420 velocity nylon
- Internal divider for carrying up to two firearms or separated upper/lower AR-15 receivers (up to 29" long)
- Padded walls with inner shell hide firearm outlines
- Heavy-duty lockable zipper sliders

65DC63 | GYRD, GYBK, GYBL | \$64.99



Diversi^on™ Board Pack **NEW!**

This simple single-pocket pack gives new meaning to the phrase "hidden in plain sight." Featuring a muzzle retainer, retention strap and padded divider, the Diversi^on Carry Board Pack is built to carry firearms securely and discreetly.

- Constructed of 420 denier velocity nylon (BKRD, GYBK, GYBL) or 500 denier nylon (RGCT)
- Discreetly transport long guns with folding stocks, short barrels or AR platform divided into upper/lower halves (up to 29" long)
- Interior lined with S.T.R.I.K.E.® webbing for attaching holsters, pouches or accessories
- Includes muzzle retainer, retention strap and padded divider

65DC60 | BKRD, GYBK, GYBL, RGCT | \$144.99



Diversi^on™ Workout Bag **NEW!**

Keep your firearms safe and concealed with the Diversi^on Workout Bag. Designed with the appearance of an everyday gym bag, this ingenious design lets you carry multiple firearms and even gives you room to store additional items.

- Constructed of 420 velocity nylon
- Main compartment extends into end pockets to fit firearms or receivers
- Removable multi-compartment divider for carrying multiple firearms or separated upper/lower receivers (up to 29" long)
- Internal loop sections for additional hook-back pouches, holsters and accessories
- Hidden panel in end pockets to extend main compartment for longer items
- Large main compartment fits several additional items

65DC62 | BKRD, GYBK, GYBL | \$174.99

Diversion™ Range Bag NEW!

Discreetly transport handguns, ammunition and other shooting gear in the Diversion Range Bag. It's designed with the color and shape of a common gym bag, but its main function is to keep all your range items hidden from prying eyes.

- Constructed of 420 velocity nylon
- Two end pockets with hidden handgun compartments
- Large main compartment with adjustable dividers
- Two pockets for magazines and gun cleaning supplies

65DC61 | BKRD, GYBK, GYBL | \$149.99



Diversion™ Courier Bag NEW!

The Diversion Courier Bag masquerades as an ordinary messenger bag but has been enhanced for your personal protection needs. Carry a firearm, spare mags and other essential items safely thanks to this unique design.

- Constructed of industrial-strength 500 denier nylon
- High-quality zippers with easy-grip pull tabs
- Reinforced bottom with metal grommets for drainage
- Padded back for comfortable wear
- Durable web carry handle
- Removable 2" padded shoulder strap side-release buckles
- Removable flap with inner map pocket and side-release buckle closure
- Dual-access, loop-lined hidden compartment on rear of bag
- Pass-through zipper in lid for main compartment access without lifting flap
- Configurable front pocket with option for full-length zippered top or adjustable dividers with bungee retainers for rifle/pistol magazines (fits four M16 or AK mags and a single pistol mag or four M14 mags, etc.)
- Three rows of S.T.R.I.K.E.® webbing on front pocket for attaching pouches or accessories
- Two side pockets with elastic loops for pistol magazines, lights, knives, multi-tools, etc.
- Main compartment with large zippered mesh pocket, two elastic mesh pockets, eight elastic loops and large pocket
- Elastic-covered port for routing hydration tube, radio antenna, or communication system wires
- Additional zipper front pocket
- Dimensions: 9.75"L x 13.5"W x 4.75"D (main comp.), 5"L x 4.5"W x 1.75"D (side pockets), 4.75"L x 13.25"W x 1"D (front pocket)
- Weight: 2.7 lbs.

65DC66 | BK, CT, GYBK, RGCT | \$139.99



Diversion™ Padded Weapon Transport Insert NEW!

Transform an ordinary bag into a weapon case with the Diversion Padded Weapon Transport Insert.

- Constructed of 420 velocity nylon
- Padding protects firearm during transport
- Provides assembled rifle coverage up 32" with single long fold
- Multiple pockets covering up to 21" for separated upper and lower halves
- Hook & loop straps secure insert in closed/folded positions

80PI00 | BK, CT, FG | \$24.99



Diversion™ Carry Sling Pack NEW!

If you're looking for a small pack to conceal a weapon and keep everyday items handy, then the teardrop-shaped Sling Pack is the one for you. Featuring common color schemes, this seemingly ordinary pack allows you to carry a pistol securely without drawing attention.

- Constructed of 420 denier velocity nylon
- High-quality lockable zippers with easy-grip pull tabs
- Adjustable for ambidextrous wear
- Durable web carry loop on top
- Padded shoulder sling with two rows of S.T.R.I.K.E.® webbing for attaching pouches or accessories
- Ambidextrous zipper access to main compartment
- Padded back for comfortable wear
- Internal loop panel and dual zippered mesh pocket in main compartment
- Large front zipper pocket with key lanyard and two smaller pockets
- Additional small front zippered pocket
- Dimensions: 13.25"L x 7.5"W x 3.25"D

65DC65 | BKRD, GYBK, GYBL | \$54.99

**Diversion™ Carry Backpack NEW!**

Featuring a hidden weapon compartment with access through a half-moon pad on the back panel, this casual backpack design is ideal for carrying concealed in style.

- Constructed of 420 denier velocity nylon (BKRD, GYBK, GYBL) or 500 denier nylon (RGCT)
- Internal loop panels for attaching hook-back holsters, pouches or accessories
- Padded shoulder straps
- Ambidextrous zipper access to main compartment
- Padded divider to separate contents inside main compartment
- Large front zipper pocket with key lanyard and additional smaller pockets
- Front mesh pocket for quick access to contents
- Slash pocket across entire pack front
- Bottom-front pocket with split design for additional storage

65DC64 | BKRD, GYBK, GYBL, RGCT | \$134.99

**Diversion™ Adjustable Hook-Back Holster NEW!**

The back of this clever holster is covered in hook material to facilitate mounting on loop panels found in our Diversion bags and packs. Its minimalist design offers a simple, lightweight solution for securing handguns in a discreet manor.

- Straightforward, ambidextrous design
- Adjustable 3" wide webbing fits a wide variety of handguns
- Adjustable retention strap with thumb break

40HB00 | BK | \$13.99



Mount any of our hook-back pouches to the inside of our Diversion™ bags and packs. See page 208 for full listing of hook & loop pouches.

Brick Go Bag **NEW!**

This low-profile “go bag” makes storing and transporting your gear a breeze. Its sling-style design allows you to rotate the bag forward for quick access to contents. When you’re done, just nudge the bag to your back again while it’s still slung over your shoulder

- Padded shoulder strap for rapid “grab and go” capability
- Large loop-lined main compartment with adjustable dividers
- Two external pockets with internal elastic loops for small items

22GB03 | BK, CT, OD, FG, RGCT | \$99.99



Block Go Bag **NEW!**

Combining multiple rows of S.T.R.I.K.E.® webbing and a variety of compartments, this customizable “go bag” is perfectly sized and adapted to meet all your storage needs.

- Seven removable heavy-duty mesh interior pouches with clear windows to label contents
- Multiple carry handles
- Padded, removable shoulder straps for backpack or sling pack configuration
- Shoulder straps can be stowed inside padded back panel
- Internal and external S.T.R.I.K.E.® webbing for attaching pouches or accessories
- External zipper pocket and various lash-down points
- Three-sided zipper allows the main compartment to be fully opened for bag to lay flat or be hung vertically using the integral strap

22GB00 | BK, CT, OD, FG, MC | \$189.99 (MC = \$199.99)



Did you know? S.T.R.I.K.E.® webbing—our version of popular PALS/MOLLE webbing—is used to attach smaller pouches or accessories onto load-bearing platforms. See our full line of modular pouches on page 196 – 214.

Go Box Mag Bag **NEW!**

Designed for resupply or load-out storage, the Go Box Mag Bag is ideal for carrying spare mags, optics, medical supplies or other necessities. It’s slim, flat profile makes for easy storage and stacking.

- Two-way, three-sided zipper allows the lid to fully open for easy access to contents
- Padded shell protects contents
- Multiple handles and D-rings for shoulder or backpack straps
- Loop-lined interior with multiple hook-back dividers and organizers
- Can be lashed to car seats, backpacks, S.T.R.I.K.E.® or PALS/MOLLE platforms, etc.

22GB04 | BK, CT, OD | \$79.99



Go Box Sling Pack NEW!

Featuring a simple ambidextrous design for quick access, these sling-style packs are the perfect standalone “go bags” for storing or staging essential contents on a shelf or in a vehicle.

- Same volume as one .50 cal M2A1 ammo can (22GB05)
- Same volume as two .30 cal M19A1 ammo cans (22GB06)
- Same volume as two .50 cal M2A1 ammo cans (22GB07)
- Loop lining with removable dividers for customization
- Loop panel for ID tagging of contents
- Stow-away shoulder strap
- S.T.R.I.K.E.[®] webbing for attaching pouches or accessories
- Sling-style carry allows bag to be rotated to front for access to contents and returned to the back while still slung

Go Box Sling Pack 150 | 22GB05 | BK, CT, OD, MC | \$74.99 (MC = \$89.99)

Go Box Sling Pack 230 | 22GB06 | BK, CT, OD, MC | \$89.99 (MC = \$109.99)

Go Box Sling Pack 250 | 22GB07 | BK, CT, OD, MC | \$99.99 (MC = \$129.99)

**Go Box Ammo Bag NEW!**

This small general purpose bag serves as a convenient alternative to ammo cans and boxes. Featuring the capacity of a single ammo can (either .30 cal or .50 cal), you'll be able to carry loose ammo or empty brass at your fingertips.

- Same volume as a single .30 cal ammo can (22GB01)
- Same volume as a single .50 cal ammo can (22GB02)
- Roll-up/down lid for easy access and secure transport
- Full wraparound carry handles for superior weight support
- Heavy-duty D-rings for shoulder strap attachment
- External utility pouch for mag loaders or other small items
- Loop patch to attach content identifiers

Go Box 30 Ammo Bag | 22GB01 | BK, CT | \$34.99

Go Box 50 Ammo Bag | 22GB02 | BK, CT | \$37.99

**Battle Bag**

Whether you're in the field or on the go, this over-the-shoulder carry bag organizes all your tactical necessities, including comms, chem-lights, handguns, mags, GPS units and maps.

- Constructed of 1000 denier nylon with reinforced stitching
- Full wraparound shoulder strap for superior weight support
- High-quality YKK[®] zippers with easy-grip pull tabs
- Stow-away waist strap for stability
- Internal elastic loops for chem-lights
- Internal hook & loop section for handgun, mag or other modular pouches
- Two dividers create three internal sections
- External zippered accessory pocket with elastic securing bands holds three magazines
- External zippered pouches hold GPS, phone, etc.
- Map pocket inside storm flap with side-release closure
- Internal pouch for handheld radio with antenna access
- Dimensions: 580 cu. in. (total), 11"L x 5"W x 10"D, 9.5"L x 13"W x 0.25"D (map pocket), 4"L x 5"W (pouch)

60BB02 | BK, CT, OD, FG | NSN# 8465-01-549-8429 (BK), NSN# 8465-01-529-9154 (CT) | \$99.99



Tactical Handbag

This over-the-shoulder bag puts a tactical spin on the popular messenger bag design. With a waterproof interior and non-slip bottom, the contents will stay protected and in place even when you're on the go.

- Constructed of 1000 denier nylon with reinforced stitching
- Waterproof internal lining and non-slip bottom protect contents
- Adjustable shoulder strap with non-slip pad
- High-quality YKK® zippers with easy-grip pull tabs
- Sure-grip, rubberized nylon carry handle
- Hook & loop nametag strip on flap for identification
- External zipper compartment on back
- Removable acrylic business card window on back
- Bellowed side pockets for quick access
- Open pocket on left front and pen channels on right side
- Hook & loop pouch on front or cell phone or other items
- Mesh zipper pocket and two elastic securing loops for chem-light or small flashlight on back of flap
- Removable internal zipper pouch with hook & loop and snap attachments
- Internal key ring keeper and hook & loop back panel
- Dimensions: 10.5"L x 7"W x 4"D = 294 cu. in.

60TH00 | BK, CT, FG | \$59.99



Enhanced Battle Bag

Designed to be kitted out based on mission requirements, this enhanced modular "go bag" is large enough to fit all your essentials, including a small laptop.

- Constructed of 1000 denier nylon with reinforced stitching
- Full wraparound shoulder strap with non-slip pad for superior weight support
- High-quality YKK® zippers with easy-grip pull tabs
- Reinforced carry handle on top of flap or on top of bag when map is detached
- Flap doubles as detachable map case
- Nametag window on flap
- Heavy-duty D-rings for securing external items
- S.T.R.I.K.E.® webbing for attaching pouches or accessories
- Internal divider for customizable storage
- Dimensions: 12"L x 12"W x 5"D = 720 cu. in.

60BB01 | BK, CT, FG | NSN# 8465-01-549-8429 (BK), NSN# 8465-01-529-9154 (CT) | \$119.99



Coyote Tan



Foliage Green



Black



Internal dividers



Stealth Enhanced Battle Bag NEW!

Get all the utility of our popular Enhanced Battle Bag with this sleek, low-key “go bag.” Featuring minimal S.T.R.I.K.E.® webbing, the Stealth Enhanced Battle Bag offers a more discreet design that doesn’t scream, “Tactical!”

- Constructed of 500 denier nylon
- Removable flap with clear map case
- Non-slip pad on shoulder strap
- Carry handles on top when flap is attached or removed
- Loop section on flap for ID panels
- Stretch pockets on sides for water bottles
- Internal loop panels for attaching additional accessories
- Dimensions: 12”L x 12”W x 5”H = 720 cu. in.

60BB03 | BK, CT, FG, RGCT | \$99.99

**Field Medical Services Bag**

With S.T.R.I.K.E.® webbing on three sides for convenient pouch or accessory attachment, this enhanced modular “go bag” provides exceptional versatility to meet all your needs.

- Constructed of 1000 denier nylon with reinforced stitching
- Full wraparound shoulder strap with non-slip pad for superior weight support
- High-quality YKK® zippers with yellow pull tabs and reflective cording
- Reflective gray piping for easy visibility
- Reinforced carry handle on top of flap or on top of bag when map is detached
- Flap doubles as detachable map case
- Nametag window on flap
- Heavy-duty D-rings for securing external items
- Internal dividers for customizable storage
- Dimensions: 12”L x 12”W x 5”D = 720 cu. in.

60EB01 | BK, RD | \$126.99

**Courier Bag NEW!**

Carry your essential everyday items securely in the low-visibility Courier Bag! Your laptop or concealed handgun will stay protected thanks to a large padded compartment inside the bag.

- Side-release buckles and hook & loop closure options
- Zipper pocket on lid for additional storage
- Two-way pass-through zipper for quick access to main compartment
- Spacious main compartment with S.T.R.I.K.E.® webbing and loop panel for attaching pouches and accessories
- Key clip and multiple small pockets for miscellaneous items
- Laptop compartment with loop material for attaching hook-back holsters and accessories
- Two external stretch pockets for water bottles or other items
- Padded shoulder strap and carry handle

61CB02 | BK, CT, GYBK, RGCT | \$99.99



Covert Carry Messenger Bag

The Covert Carry Messenger Bag lets you carry everything you may need at a moment's notice, including a handgun, mags, pens, glasses, ID or other accessories.

- Constructed of 1000 denier nylon with reinforced stitching
- Full wraparound shoulder strap for superior weight support
- High-quality YKK® zippers with easy-grip pull tabs
- Quick-adjust flip-lock buckle on shoulder strap for across-the-chest, shoulder or tight underarm carry
- Removable waist belt for stability
- External back panel with two concealed mag pockets and center pocket with hook & loop for holster mounting
- Two loops on bottom for securing external items
- Large padded laptop compartment
- External zippered pocket with internal key fob on front of main compartment
- Large zipper pocket with two internal sleeves, small zipper pocket, clear ID window, three pen sleeves, accessory sleeve and soft lined eyeglass pocket inside main compartment
- Dimensions: 20"L x 14"W x 8"D = 2240 cu. in. (total), 19"L x 11"W x 5"D (main comp.), 14"L x 11"W x 2"D (laptop comp.)

60MB01 | BK, CT | \$99.99



Concealed pockets for handguns and spare mags

Advanced Tactical Briefcase

The Advanced Tactical Briefcase is ideal for both civilian travel and tactical operations.

- Constructed of 1000 denier nylon with reinforced stitching
- Waterproof internal lining protects contents
- Robust shoulder strap and carry handle
- High-quality YKK® zippers with easy-grip pull tabs
- Two hook & loop patches and removable vinyl ID window
- Padded hook & loop-secured laptop pocket
- External laptop access through waterproof zipper
- Three easy-access external pockets for cell phone, PDA, etc.
- Rear slot for pull-handle access (compatible with all wheeled luggage)
- Clear map case on inside of outer flap
- Five additional internal compartments
- Dimensions: 13"L x 16"W x 5"D = 610 cu. in./10 L

61BC01 | BK, CT, FG | \$155.99



Black



Coyote Tan



Foliage Green



Command Bag

The Command Bag's unique, functional design is perfect for work or travel, giving you generous storage options.

- Constructed of 1000 denier nylon with reinforced stitching
- Waterproof lining protects contents
- Robust shoulder strap and carry handle
- High-quality YKK® zippers with yellow pull tabs and reflective cording
- Reflective gray piping for easy visibility
- Two hook & loop patches and removable vinyl ID window
- Padded hook & loop-secured laptop pocket
- External laptop access through waterproof zipper
- Three easy-access external pockets for cell phone, PDA, etc.
- Rear slot for pull-handle access (compatible with all wheeled luggage)
- Clear map case on inside of outer flap
- Five additional internal compartments
- Dimensions: 13"L x 16"W x 5"D = 610 cu. in.

61CB00 | BK, RD | \$159.99

**Travel Shave Kit Bag NEW!**

The Travel Shave Kit Bag carries all your shaving supplies securely thanks to water-resistant construction and bound, double-stitched edges. Whether you're traveling overseas or heading out on a backpacking excursion, this two-pocket bag is a must-have travel companion.

- Constructed of 500 denier ripstop (solid colors) or CORDURA® nylon (MultiCam®)
- Durable nylon carry handle
- Dimensions: 8.5"L x 7.5"W x 4.5"D (total), 8.5"L x 5.25"W x 4.5"D (main pocket), 8.5"L x 2.25"W x 4.5"D (side pocket)
- Weight: 0.46 lbs.

20SK01 | BK, CT, OD, MC | \$24.99 (MC = \$27.99)

**General Purpose Mini Gear/Medical Bag NEW!**

This multipurpose bag can be used in any circumstance requiring quick access to medial gear or any other small equipment.

- Constructed of 500 denier nylon
- Three-pocket gear/medical bag
- Durable carry handles for added strength
- D-rings on ends for optional shoulder strap
- Loop panel on front (3" x 4")
- Dimensions (20MB01): 13.5"L x 10"W x 7.5"D = 0.93 cu. in. (total), 13.5"L x 5.25"W x 7.5"D (main pocket), 11.5"L x 2.5"W x 6.75"D (side pockets)
- Dimensions (20MB02): 11.5"L x 10"W x 5.75"D = 0.80 cu. in. (total), 11.5"L x 5.25"W x 5.75"D (main pocket), 9.25"L x 2.5"W x 5.25"D (side pockets)

Large | 20MB01 | BK, CT, OD | \$41.99

Small | 20MB02 | BK, CT, OD | \$35.99



BDU Mini Pocket Pack

Designed to fit inside those big cargo pockets on your BDUs, field jacket or travel vest, this compact bag will help keep small items organized and within reach. A built-in lanyard keeps your keys securely in place while internal elastic loops hold pens, lights or spare batteries.

- Constructed of 500 denier ripstop (solid colors) or CORDURA® nylon (MultiCam®)
- Durable nylon carry handle with 4" loops
- Two internal pockets with elastic loops and key lanyard for gear storage
- Zippered closure for added security
- Dimensions: 4.75"L x .75"W x 6.75"D
- Weight: 0.2 lbs.



20PK01 | BK, CT, OD, MC | \$20.99 (MC = \$21.99)

CIA Garment Travel Bag

For years, clandestine operatives have had the luxury of owning custom garment bags with nooks and crannies for all sorts of stuff you'd rather keep hidden. We secured this design and enhanced it to produce a sophisticated garment travel bag that has been repeatedly and independently reviewed with comments such as "It surpasses anything else on the market!"

- Constructed of 1000 denier nylon with reinforced stitching
- Adjustable shoulder strap with non-slip pad
- High-quality YKK® zippers with easy-grip pull tabs
- Heavy-duty top and carry crossbars
- Top and folded middle carry handles with fighter grip handle
- Dual side-release securing straps when folded
- Zip-up and side-release attachments for internal clothing cover
- Internal zipper compartments
- Protective, removable shoe pouch
- Two external pockets for separating clean and soiled clothing
- Dimensions: 25"L x 43"W x 5"D = 5375 cu. in. (main comp.)



20GB00 | BK | NSN# 8465-01-517-6318 | \$279.99

Stash Away Duffel

Use the Stash Away Duffel at full capacity and then fold it up and pack it away in your suitcase until you need it again.

- Constructed of lightweight 210 denier nylon ripstop
- Folds up into a small zippered pouch when not in use
- Durable nylon carry handles
- Adjustable, removable nylon shoulder strap
- Dimensions: 20.5"L x 9"W x 9"H = 1660.5 cu. in. (open main comp.), 7.5"L x 2"W x 6.25"H (folded main comp.), 7.25"L x 6.5"H = 47 cu. in. (front)



20DS00 | BK | \$23.99

Pro-Range/Travel Bag

With an external zipper pouch, small zipper pocket and open stuff compartment, the Pro-Range/Travel Bag is the perfect economical carry bag for the range or an overnight stay.

- Constructed of 1000 denier nylon with reinforced stitching
- Full wraparound carry handles for superior weight support
- Shoulder strap with non-slip pad
- High-quality YKK® zippers with easy-grip pull tabs
- Dimensions: 27"L x 10"W x 15"D = 4050 cu. in.

20TB03 | BK | \$89.99

**Enhanced Pro Shooter's Bag**

Lined with .375" closed-cell foam to shield your gear from impact, the all-purpose Enhanced Pro Shooters Bag has a 2" BTS™ webbing system for internal pouch storage and convenient access.

- Constructed of 1000 denier nylon with reinforced stitching
- Full wraparound carry handles for superior weight support
- Detachable shoulder strap with non-slip pad
- High-quality YKK® zippers with easy-grip pull tabs
- Zippered utility pockets at both ends
- Dimensions: 7"L x 17"W x 12.5"D = 1488 cu. in.

80SB06 | BK | NSN# 1095-01-522-1066 | \$134.99

**Pro Training Bag**

The Pro Training Bag features a top opening with ready access to the main compartment and two external mesh pockets for all your other off-duty essentials.

- Constructed of 1000 denier nylon with reinforced stitching
- Full wraparound carry handles for superior weight support
- Adjustable, detachable shoulder strap with non-slip shoulder pad
- High-quality YKK® zippers with easy-grip pull tabs
- Two external mesh pockets
- Dimensions: 19"L x 10"W x 12"D = 2280 cu. in.

20SP00 | BK | \$119.99



Fire/EMS Pro Training Bag

Perfect for the gym or other off-duty activities, this multi-use bag carries all your locker room necessities with additional storage for items like soap, deodorant, towels and razors.

- Constructed of 1000 denier nylon with reinforced stitching
- Full wraparound carry handles for superior weight support
- Adjustable, detachable shoulder strap with non-slip shoulder pad
- High-quality YKK® zippers with yellow pulls and reflective cording
- Reflective gray piping and handles for easy visibility
- Two external mesh pockets
- Dimensions: 19"L x 10"W x 12"D = 2280 cu. in.

20EP00 | BK, RD | \$134.99



Crowd Control Bag

Designed to carry crowd control or SWAT tactical equipment, the Crowd Control Bag has a separate compartment for helmet storage and a spacious main compartment for other gear.

- Constructed of 1000 denier nylon with reinforced stitching
- Full wraparound carry handles for superior weight support
- Adjustable, removable shoulder strap
- High-quality YKK® zippers with easy-grip pull tabs
- Reinforced with polymer stiffeners
- ID panel on front pocket
- Padded helmet compartment
- External pouches and straps to secure baton or flashlight
- Dimensions: 5005 cu. in. (total), 21.5"L x 11"W x 13"D (main comp.), 13.5"L x 11"W x 13"D (helmet comp.)

20CC00 | BK | \$89.99



Step In Bag

With the Step In Bag, we've taken the hassle out of the equation to give you a quick and convenient option for storing your gear. Simply step inside the bag, dump your gear and continue on your way.

- Constructed of 1000 denier nylon with reinforced stitching
- Full wraparound carry handles for superior weight support
- High-quality YKK® zippers with large yellow pull tabs
- Reflective gray piping for easy visibility
- Clear ID window
- Dimensions: 14.5"L x 19.25"W x 17.5"H = 4884 cu. in. (main comp.), 14"L x 11.5"H = 322 cu. in. (side pockets)

20SI00 | BK, RD | \$67.99



EMS Equipment Bag

This industry-standard bag is equally at home in a truck, ambulance or at your desk. Its large main compartment has an adjustable, removable divider and a row of 2" BTS™ webbing that allows you to customize the bag to suit your needs.

- Constructed of 1000 denier nylon with reinforced stitching
- Full wraparound carry handles for superior weight support
- Reinforced with internal polymer stiffeners
- Adjustable, detachable shoulder strap
- Heavy-duty lockable YKK® zippers with yellow pulls and reflective cording
- Reflective gray piping and handles for easy visibility
- Fully padded lid
- Pen holder slots
- Internal/external zipper pouches and three external pouches with hook & loop flaps
- Dimensions: 1758 cu. in. (total), 18.5"L x 12"W x 7"D (main comp.), 8"L x 5.5"W x 1.5"D (side pouch), 8"L x 4"W x 1"D (hook & loop pouch), 7"L x 8"W x 1"D (hook & loop pouch), 8"L x 3.5"W x 1"D (hook & loop pouch), 5.5"L x 4"W x 1"D (internal pouches)

20EE00 | BK, RD | \$79.99



Police Equipment Bag

From cruiser to desk, your gear will rest comfortably in this industry-standard equipment bag. Its large main compartment features a single row of 2" BTS™ webbing that allows you to customize the bag with additional pouches or accessories.

- Constructed of 1000 denier nylon with reinforced stitching
- Full wraparound carry handles for superior weight support
- Reinforced with internal polymer stiffeners
- Adjustable, removable shoulder strap
- Heavy-duty lockable YKK® zippers with easy-grip pull tabs
- Fully padded lid
- Two external zippered pouches, three external open-top pouches and two external straps to secure baton or flashlight
- Two internal zippered pouches and pen holder slots
- Dimensions: 1731 cu. in. (total), 7.5"L x 12"W x 18.5"D = 1665 cu. in. (total), 8"L x 5.5"W x 1"D (external pouches), 5.5"L x 4"W x 1"D (internal pouches)

20PE00 | BK | \$69.99



Fun Fact: BTS™ webbing is a single row of 2" webbing that allows you to customize your bag by attaching modular pouches or accessories. This webbing system is compatible with all our belt-mounted pouches. See page 209.

CZ Gear Bag

Maximize your storage capacity with the CZ Gear Bag! The unique corner-zipper design gives you limitless access to all the gear you could possibly need.

- Constructed of 1000 denier nylon with reinforced stitching
- Full wraparound carry handles for superior weight support
- High-quality YKK® zippers with easy-grip pull tabs
- Adjustable shoulder strap with reversible, non-slip shoulder pad
- Dimensions: 33.5"L x 16"W x 15"D = 8040 cu. in.

20CZ00 | BK | NSN# 8465-01-517-6330 | \$90.99



Corner-zipper design

Mobile Operation Bag

This operator-friendly gear/travel bag can be used as a backpack, shoulder bag or storage bag—depending on your mission or preference.

- Constructed of 1000 denier nylon with reinforced stitching
- Full wraparound carry handles for superior weight support
- High-quality YKK® zippers with easy-grip pull tabs
- Two padded, detachable shoulder straps
- External lockdown zipper flap
- Heavy-duty D-rings for securing external items and shoulder straps
- Dimensions (20MB02): 24"L x 12"W x 9"D = 3850 cu. in. (total), 22"L x 10"W x 2"D (large pocket), 10.5"L x 10"W x 2"D (small pockets)
- Dimensions (20MOB3): 27"L x 14"W x 10"D = 5500 cu. in. (total), 24"L x 12"W x 3"D (large pocket), 12"L x 12"W x 3"D (small pockets)

Medium | 20MOB2 | BK, CT | \$110.99

Large | 20MOB3 | BK, CT, FG | NSN# 8465-01-517-6320 (BK) | \$122.99



Fire/EMS Mobile Operation Bag

Designed for first responders, this versatile gear/travel bag can be transformed into a backpack, shoulder bag or storage bag.

- Constructed of 1000 denier nylon with reinforced stitching
- Full wraparound carry handles for superior weight support
- Padded, detachable shoulder straps with non-slip material
- High-quality YKK® zippers with yellow pull tabs and reflective cording
- Reflective gray piping and handles for easy visibility
- External lockdown zipper flap
- Heavy-duty D-rings for securing external items and shoulder straps
- Water-resistant, zipper-sealed front pocket with padded laptop section (20EO01 only)
- Dimensions (20EO01): 2522 cu. in. (total), 19"L x 8.5"W x 11"D (main comp.), 16"L x 10"W x 3"D (front pocket), 14"L x 9.5"W x 2"D (laptop section)
- Dimensions (20EO03): 27"L x 14"W x 10"D = 5500 cu. in. (total), 19"L x 8.5"W x 11"D (main comp.), 24"L x 12"W x 3"D (large pocket), 12"L x 12"W x 3"D (small pockets)

Small | 20EO01 | BK, RD | \$129.99

Large | 20EO03 | BK, RD | \$139.99



O2 Bag

Transport your oxygen tank, regulator and other supplies securely in the rugged O2 Bag.

- Constructed of 1000 denier nylon with reinforced stitching
- High-quality padding protects oxygen tank and regulator
- Heavy-duty lockable YKK® zippers with yellow pull tabs and reflective cording
- Reflective gray piping and handles for easy visibility
- External mesh-lined compartments
- Two external storage pockets with elastic securing strip
- Dimensions: 21"L x 12.5"W x 8.5"D = 2231 cu. in.

20O200 | BK, RD | \$154.99





O2 Sleeve with Hood

Carry your D or Super D O2 cylinder safely in the lightweight, padded O2 Sleeve with Hood.

- Constructed of 1000 denier nylon with reinforced stitching
- Designed for use in line of duty or for personal medical needs
- Heavy-duty nylon web handle with reflective tape
- Reflective gray piping
- Removable hood
- Protects cylinder from moisture
- Multiple rows of S.T.R.I.K.E.® webbing for attaching to backpacks, gear bags and vests or for gurney attachment during patient transport
- Multiple D-rings for securing external items
- Cinch straps for secure fit
- Dimensions: 15"L x 5"W x 4.75"D = 356.25 cu. in. (main comp.), 8"L x 7"W (hood)

200201 | BK, RD | \$49.99

Enhanced Diver's Travel Bag

Our Enhanced Diver's Travel Bag is a great multi-use bag with superior workmanship. It unzips and folds out flat for quick, convenient loading.

- Constructed of 1000 denier nylon with reinforced stitching
- Extended handle for towing
- .375" closed-cell foam padding
- High-quality YKK® zipper with easy-grip pull tabs
- Durable inline-skate wheels (20LO03BK only)
- Available with soft bottom, backpack straps and no wheels (21DT03BK only)
- Dimensions: 16"L x 11"W x 26.5"D = 7350 cu. in.

With Wheels | 21DT03 | BK | NSN# 8465-01-495-5058 | \$229.99

Without Wheels | 21DT00 | BK | \$182.99



P.U.L.S.E. Bag

Are you sick of back problems from lugging your gear bags? With multiple compartments for optimum versatility, this bag is the answer.

- Constructed of 1000 denier nylon with reinforced stitching
- Zippered mesh dividers in all compartments
- Top dual-access (from outside or inside) compartment
- External compression straps stabilize load
- Hideaway pull handle and full wraparound carry handles for superior weight support
- Unzips and folds out flat
- Heavy-duty lockable YKK® zippers with yellow pull tabs
- Reflective gray piping and handles for easy visibility
- Durable in-line skate wheels and reinforced corners
- External ID panel
- Dimensions: 30"L x 16"W x 14"D = 6720 cu. in.

20PL00 | BK, RD | \$249.99



Medium A.L.E.R.T.™ Bag

Combining exceptional compartmentalization and versatility, this unique load-out bag unzips and folds out flat for quick, convenient loading.

- Constructed of 1000 denier nylon with reinforced stitching
- Zippered mesh dividers in all compartments
- Top dual-access (from outside or inside) compartment
- External compression straps stabilize load
- Hideaway pull handle and full wraparound carry handles for superior weight support
- Heavy-duty lockable YKK® zippers with easy-grip pulls
- Durable in-line skate wheels and reinforced corners
- Padded top pockets fold flat when not in use
- Dimensions: 30"L x 16"W x 14"D = 6720 cu. in.

20LO04 | BK | NSN# 8460-01-529-5774 | \$236.99



A.L.E.R.T.™ Bag

With generous storage capacity and an assortment of customizable compartments, the A.L.E.R.T. Bag is the ultimate in complete gear organization and transportation.

- Constructed of 1000 denier nylon with reinforced stitching
- Hideaway pull handle and full wraparound carry handles for superior weight support
- Heavy-duty lockable YKK® zippers with easy-grip pull tabs
- Large U-shaped, hinge-type lid for easy access
- Two padded end-cap handles for two-person carry
- Nine internal mesh pouches for gear storage
- Four clear ID insert pockets (two on top and one at each end)
- Reinforced corners and stiffeners on bottom
- Durable inline-skate wheels (20LO03BK only)
- Available with soft bottom, backpack straps and no wheels (20LO00BK only)
- Dimensions: 43"L x 15"W x 13"D = 8385 cu. in.

With Wheels | 20LO03 | BK | NSN# 8465-01-517-6319 | \$299.99

Without Wheels | 20LO00 | BK | \$267.99



Enhanced Tactical Rope Bag

- Constructed of Type 4 nylon webbing
- Holds up to 200 feet of rope (rope not included)
- Drawstring sleeve for full bag closure
- Drawstring pocket holds excess drawstring
- Quick-release buckle belt attachment
- Grommets on bottom of bag for drainage
- External pocket for carabiners
- Quick-disconnect leg straps with high-visibility red pull tabs
- Dimensions: 22"L x 5.5"W x 10"D

20TR03 | BK | \$69.99





A.L.E.R.T.™ 5 Bag

With big-time storage capacity and dozens of smart organization options, the A.L.E.R.T. 5 Bag is our largest load-out bag offered!

- Constructed of 1000 denier nylon with reinforced stitching
- External compression straps stabilize load
- Hideaway pull handle and full wraparound carry handles for superior weight support
- Removable daisy-chain handle
- Large U-shaped, hinge-type lid for easy access
- Multiple heavy-duty D-rings for securing external/internal items or palletizing
- Two padded end-cap handles for two-person carry
- Heavy-duty lockable YKK® zippers with easy-grip pull tabs
- Durable inline-skate wheels and reinforced corners and stiffeners on bottom
- Multiple rows of S.T.R.I.K.E.® webbing for attaching pouches or accessories
- Coyote Tan pack cloth lining for interior visibility
- Internal 2" webbing along top and bottom of sides
- Large 33" x 14" weapon sleeve with heavy padding to protect long guns
- Large 29" x 11" external compartment with zipper pocket, clear internal organizer and mesh pocket
- Three 8" x 10" external clear window pockets for manifesting, content inventory or identification
- Dimensions: 35"L x 21.5"W x 17"D = 9684.5 cu. in. (total), 34"L x 18"W x 14"D = 8568 cu. in. (main comp.), 29"L x 11"W x 3.5"D = 1116.5 cu. in. (external comp.)

20LO05 | BK | \$429.99



U.S.A.R. Bag

Designed to give first responders limitless storage and organization options, the customizable U.S.A.R. Bag is our biggest fire/rescue load-out bag to date!

- Constructed of 1000 denier nylon with reinforced stitching
- External compression straps stabilize load
- Hideaway pull handle and full wraparound carry handles for superior weight support
- Removable daisy-chain handle
- Large U-shaped, hinge-type lid for easy access
- Multiple heavy-duty D-rings for securing external/internal items or palletizing
- Two padded end-cap handles for two-person carry
- Heavy-duty lockable YKK® zippers with large yellow pull tabs
- Reflective gray piping and handles for easy visibility
- Durable inline-skate wheels and reinforced corners and stiffeners on bottom
- Multiple rows of S.T.R.I.K.E.® webbing for attaching pouches or accessories
- Coyote Tan pack cloth lining for interior visibility
- Internal 2" webbing along top and bottom of sides
- Large 33" x 14" weapon sleeve with heavy padding to protect long guns
- Large 29" x 11" external compartment with zipper pocket, clear internal organizer and mesh pocket
- Three 8" x 10" external clear window pockets for manifesting, content inventory or identification
- Dimensions: 43"L x 15"W x 15"D = 9675 cu. in.

20US00 | BK, RD | \$429.99

Cyane™ Dynamic Pack **NEW!**

Featuring multiple rows of S.T.R.I.K.E.® webbing and several storage compartments, this low-profile day pack can be configured as a standalone backpack or converted into a PALS/MOLLE-compatible pack that attaches to armor carriers and vests. The options are limitless!

- Constructed of durable yet lightweight 500 denier ripstop (solid colors) or CORDURA® nylon (MultiCam®)
- Removable 3-D mesh padded back panel
- Carry handle with lash loops on top of pack
- Six adjustable 3/4" compression straps
- Easy-grip zipper pulls
- Removable padded shoulder straps
- Multiple rows of S.T.R.I.K.E.® webbing:
 - Seven rows on back for attaching back panel or mounting onto PALS/MOLLE platform
 - Four rows on each side
 - Three rows on front compartment with loop for attaching hook-back ID panels
- One slash pocket on main compartment and two on front compartment
- Zippered pocket (84 cu. in.) on front compartment with two rows of S.T.R.I.K.E.® webbing
- Main compartment (650 cu. in.)
- Beavertail-style compartment (595 cu. in.)
- Hydration pocket with three elastic-covered tube ports accommodates 100-oz. hydration reservoir (sold separately, see page 80)

60CD00 | BK, CT, OD, MC | \$159.99 (MC = \$189.99)



Cyane™ Stealth Pack **NEW!**

Get big-time storage in a low-key day pack. Featuring a slightly less tactical appearance than its Cyane Dynamic Pack counterpart, the Cyane Stealth Pack is perfect for everyday use.

- Constructed of durable yet lightweight 500 denier ripstop (solid colors) or CORDURA® nylon (MultiCam®)
- 3-D mesh padded back panel
- Carry handle with lash loops on top of pack
- Six adjustable 3/4" compression straps
- Easy-grip zipper pulls
- Removable padded shoulder straps
- Three rows of S.T.R.I.K.E.® webbing on front compartment with loop for attaching hook-back ID panels
- One slash pocket on main compartment and two on front compartment
- Zippered pocket (84 cu. in.) on front compartment with two rows of S.T.R.I.K.E.® webbing
- Generous main compartment (816 cu. in.)
- Beavertail-style compartment (324 cu. in.)
- Hydration pocket with three elastic-covered tube ports accommodates 100-oz. hydration reservoir (sold separately, see page 80)

60CS00 | BK, CT, FG, MC | \$139.99 (MC = \$169.99)



Did you know? S.T.R.I.K.E.® webbing—our version of popular PALS/MOLLE webbing—is used to attach smaller pouches or accessories onto load-bearing platforms. See our full line of modular pouches on page 196 – 214.

YOMP™ Pack NEW!

The YOMP Pack offers wide-open access to a generous main compartment and multiple storage compartments thanks to its unique Y-zip configuration. Unzip the top portion only or unzip the entire pack for full access to contents.

- Constructed of durable 500 denier nylon
- Durable spring steel frame for flexible, lightweight structure
- Accommodates 100-oz. hydration reservoir (sold separately, see page 80)
- High-quality zippers with large zipper pulls
- Durable quick-release buckles and integral key clasp
- Multiple rows of S.T.R.I.K.E.® webbing for attaching pouches or accessories
- Padded shoulder straps with non-slip material to keep weapon sling in place
- Adjustable sternum strap and three-point hip belt for comfort under heavy load
- Thick lumbar pad on waist belt for load-bearing support
- Adjustable external compression straps accommodate various loadouts
- Air vent support panel to create load separation and prevent load shifting
- Attachment ports on bottom for external gear storage
- Two internal padded side compartments with mesh gear-keeper gussets
- Dimensions: 18"L X 12"W X 7"D (main comp.), 15.5"L X 1.5"W X 5"D (external side comps.), 12"L x 5"W x 1"D (internal mesh pockets), 15"L X 12"W X 1"D (internal hydration sleeve), 7"L X 9"W X 1"D (top flap comp.)

60YP00 | BK, CT, RGCT, MC | \$199.99 (MC = \$245.99)



Did you know? "YOMP" is a British military acronym that stands for "Your Own Marching Pace."

**Sling Backpack NEW!**

Designed for a quick hike or trek through town, the Sling Backpack features a 3-D mesh back for comfort and a single ambidextrous, padded sling with swivel buckle for easy removal.

- Ambidextrous, non-slip shoulder sling with quick-release swivel buckle
- Bottom grommets for drainage
- Multiple rows of S.T.R.I.K.E.® webbing for attaching pouches or accessories
- External dual-entry zippered pocket
- Media player pocket with external port
- Two mesh storage pockets for loose items
- Water bottle pocket with cinch cord (fits most bottles)
- Dimensions: 12.5"L x 3.5"W x 18"H = 800 cu. in.

60SP00 | BK, CT | \$99.99



3-Day Assault™ Pack

This mid-sized, frameless backpack is the combat standard worldwide! Featuring a detachable sternum strap and padded waist belt, you'll get extreme versatility in a hardwearing package.

- Constructed of 1000 denier nylon with reinforced stitching
- Accommodates 100-oz. hydration reservoir (sold separately, see page 80)
- Sleeping bag straps and padded shoulder straps
- Heavy-duty D-rings for securing external items
- High-quality YKK® zippers and easy-grip pull tabs
- Reinforced drag/carry handle
- Removable elasticized sternum strap with silent release buckle and padded waist belt
- IVS™ (Intercooler Venting System) back panel for ventilation
- Dimensions: 2000 cu. in./37 L (total), 20"L x 13"W x 6"D (main comp.), 14.5"L x 12.5"W x 2.5"D (front comp.)

603D00 | BK, DE | \$139.99



Ultralight 3-Day Assault Pack

Get rugged storage capacity that won't weigh you down with the Ultralight 3-Day Assault Pack! S.T.R.I.K.E.® webbing covers the entire pack to give you plenty of space for extra pouches or accessories.

- Constructed of lightweight, high-tenacity 210/330 denier nylon and 210 denier ripstop nylon
- Accommodates 100-oz. hydration reservoir (sold separately, see page 80)
- High-quality YKK® zippers with easy-grip pull tabs
- Easy-access main compartment with front pocket and map pocket
- Multiple rows of S.T.R.I.K.E.® webbing for attaching pouches or accessories
- Four adjustable external compression straps accommodate various loadouts
- Five internal tie-down loops
- Padded shoulder straps
- Removable heavy-duty waist belt
- Heavy-duty D-rings for securing external items
- Loop fastener on front for ID patch attachment
- Dimensions: 2000 cu. in./37 L (total), 20"L x 13"W x 6"D (main comp.), 14.5"L x 12.5"W x 2.5"D (top-front pocket)
- Weight: 2.65 lbs.

603D08 | BK, CT, MC | \$159.99 (MC = \$199.99)

Phoenix™ Pack

The frameless, padded Phoenix Pack features contoured “S” shoulder straps with a detachable sternum strap and torso lumbar support to help you carry heavy loads comfortably.

- Constructed of 1000 denier nylon with reinforced stitching
- Accommodates 100-oz. hydration reservoir (sold separately, see page 80)
- Adjustable external compression straps accommodate various loadouts
- High-quality YKK® zippers and easy-grip pull tabs
- Multiple rows of S.T.R.I.K.E.® webbing for attaching pouches or accessories
- Reinforced drag/carry handle
- Removable elastic sternum strap with silent release buckle and padded waist belt
- Heavy-duty D-rings for securing external items
- IVS™ (Intercooler Venting System) back panel for ventilation
- Fully adjustable pack height and sway stabilizer system
- Weapon lock system lined with non-slip material
- Two sets of securing straps for ground mat, sleeping bag, etc.
- Non-slip rib tube router
- Dimensions: 2650 cu. in./46 L (total), 23”L x 12”W x 8”D (main comp.), 17.8”L x 12”W x 2”D (front comp.)

60PH00 | BK, DE | NSN# 8465-01-520-5938 | \$189.99



Non-slip rib tube router



Lightweight Phoenix™ Pack

Built slightly larger than our Ultralight 3-Day Assault Pack, the Lightweight Phoenix Pack features multiple rows of S.T.R.I.K.E.® webbing, providing ample space for attaching extra pouches and accessories.

- Constructed of lightweight, high-tenacity 210/330 denier nylon and 210 denier ripstop nylon
- Accommodates 100-oz. hydration reservoir (sold separately, see page 80)
- High-quality YKK® zippers with easy-grip pull tabs
- Easy-access main compartment with front pocket and map pocket
- Multiple rows of S.T.R.I.K.E.® webbing for attaching pouches or accessories
- Four adjustable external compression straps accommodate various loadouts
- Padded shoulder straps
- Heavy-duty D-rings for securing external items
- Removable heavy-duty sternum strap and waist belt
- Dimensions: 2175 cu. in./46 L (total), 20.5”L x 12”W x 6.75”D (main comp.), 15.75”L x 12.8”W x 2.5”D (front pocket)
- Weight: 2.65 lbs.

60PH01 | BK, CT, MC | \$189.99 (MC = \$245.99)

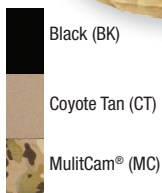

See pouches on page 196 – 214.

Velocity X1 Jump Pack

Featuring durable materials, quad-stitched seams and double-taped edges, this substantial jump pack is free-fall jumpable and is made to U.S. Special Forces specifications. It's built for extreme performance!

- Constructed of 1000 denier nylon with reinforced stitching
- Quad-stitched seams and double-taped edges
- Accommodates 100-oz. hydration reservoir (sold separately, see page 80)
- High-quality YKK® zippers and easy-grip pull tabs
- Multiple rows of S.T.R.I.K.E.® webbing for attaching pouches or accessories
- Removable heavy-duty waist belt with three rows of S.T.R.I.K.E.® webbing
- Removable, adjustable sternum strap
- Padded shoulder straps with dual-adjustment metal hardware
- Heavy-duty D-rings for securing external items
- Easy-access main compartment with front pocket and map pocket
- Four internal equipment tie-down straps, eight internal equipment tie-down loops and eight external tie-down loops for equipment lowering lines and light-sticks
- Two adjustable external compression straps with metal hardware accommodate various loadouts
- Military free-fall jumpable with reinforced attachment system on bottom
- Dimensions: 2350 cu. in. (total), 19"L x 13"W x 7"D (main comp.), 19"L x 13"W x 2.5"D (top front pocket)

603D07 | BK, CT, MC | \$239.99 (MC = \$279.99)

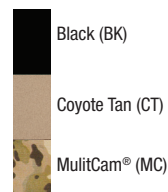

Velocity X3 Jump Pack

Made to U.S. Special Forces specifications, this robust pack features universal leg strap attachment points and is military free-fall and static-line jumpable.

- Constructed of 1000 denier nylon with reinforced stitching
- Quad-stitched seams and double-taped edges
- Accommodates 100-oz. hydration reservoir (sold separately, see page 80)
- High-quality YKK® zippers and easy-grip pull tabs
- Multiple rows of S.T.R.I.K.E.® webbing for attaching pouches or accessories
- Removable heavy-duty waist belt and removable, adjustable sternum strap
- Padded shoulder straps with dual-adjustment metal hardware
- Heavy-duty D-rings for securing external items
- Integrated single-point release harness
- Pull-out protection flap with S.T.R.I.K.E.® webbing on bottom of pack
- Easy-access main compartment with front pocket and map pocket
- Four internal equipment tie-down straps, eight internal equipment tie-down loops and eight external tie-down loops for equipment lowering lines and light-sticks
- Six adjustable external compression straps accommodate various loadouts
- Compatible with current U.S. Air items and jump-specific hardware
- Compatible with S.T.R.I.K.E.® Cutaway Tactical Armor Carriers (sold separately, see page 40)
- Dimensions: 3290 cu. in. (total), 22"L x 13"W x 8.5"D (main comp.), 18"L x 13"W x 2"D (top front pocket)

603D09 | BK, CT | \$299.99



Static-line configuration



Free-fall configuration



Universal leg strap attachment points for static-line or free-fall configuration

External port for cord routing
media players



Laptop Backpack

Store all your electronic necessities securely in the Laptop Backpack. A generously padded compartment with waterproof zipper keeps your laptop protected while you're on the go.

- Constructed of 500 denier nylon ripstop with reinforced stitching
- Breathable closed-cell foam padding protects contents
- High-quality YKK® zippers with easy-grip pull tabs
- Multiple rows of S.T.R.I.K.E.® webbing for attaching pouches or accessories
- Removable, adjustable sternum strap with side-release buckles
- Adjustable, padded shoulder straps with non-slip material
- Top grab handle
- Removable hook & loop ID window
- Media player pocket with external port for cord routing
- Padded laptop compartment with waterproof zipper
- Large zipper panel and three individual zippered pouches for organization
- Smaller compartments hold laptop accessories
- Dimensions: 14"L x 9.5"W x 4"H (main comp.), 13"L x 19"H (laptop comp.), 12"L x 1.5"W x 13.5"H (front comp.), 9.5"L x 2"W x 7.5"H (bottom front comp.), 6.25"L x 1.5"W x 5"H (top front comp.)

60LP00 | BK, CT | \$149.99



Padded laptop
compartment



Large zipper panel and
three individual zippered
pouches

Stash Pack

Keep this convenient fold-up pack stashed away in your suitcase for times when you need a little extra storage. Simply pull it out of the integrated pouch to convert it into a backpack.

- Body is constructed of lightweight 210 denier nylon ripstop
- Bottom is constructed of 330 denier nylon double ripstop
- Folds up into a small pouch when not in use
- Lightweight, compact design fits easily in suitcase
- Adjustable, padded 3-D mesh shoulder straps
- Open-top mesh pockets on sides for water bottles
- Dimensions: 8.5"L x 1.75"W x 8.5"H (folded main comp.), 10.5"L x 9.25"W x 16"H (open main comp.), 8.5"L x 8.75"H (top pocket)

60SP01 | BK | \$34.99



Folds up into small pouch
when not in use

Unfolds into lightweight stash pack





Yellow deployable rainhood included

Initial Response Backpack

Wear this rock-solid pack alone or with other Initial Response gear for a fully customizable configuration.

- Constructed of 1000 denier nylon with reinforced stitching
- Can be worn alone or with other Initial Response gear (sold separately, see page 77, 85, 172 and 260)
- Reinforced nylon carry handle
- Detachable shoulder straps
- Adjustable helmet holder on front
- High-quality zippers with yellow zipper pulls
- Multiple rows of S.T.R.I.K.E.® webbing for attaching pouches or accessories
- Deployable high-visibility yellow rain hood
- Dimensions: 16"L x 11"W x 8.5"D (main comp.), 12"L x 5"W x 2.75"D (side pockets), 16"L x 11"W x 2"D (front)

60RP01 | BK | \$159.99



Designed for first responders, our Initial Response line is a series of unique interchangeable gear, including packs, belts, harnesses and vests. See page 77, 85, 172 and 260.

Initial Response Fanny Pack

This fanny pack is designed to give you quick access to vital supplies even when it's worn on the Initial Response Web Belt or Initial Response Backpack.

- Compatible with duty belts up to 2" wide
- Can be worn with Initial Response Web Belt (sold separately, see page 85) or Initial Response Backpack (sold separately, see above)
- High-visibility yellow interior
- Multiple rows of S.T.R.I.K.E.® webbing for attaching pouches or accessories
- 1" loop on top of S.T.R.I.K.E.® webbing
- High-quality zippers with yellow pull tabs and reflective cording
- Reflective gray piping for easy visibility
- Front zipper pocket and two side zipper pockets
- Dimensions: 9"L x 8"W x 4.5"D = 324 cu. in. (main comp.), 8"L x 7"W x 1.5"D = 84 cu. in. (front pocket), 6.5"L x 4.5"W x 2.75"D = 80 cu. in. (side pockets)

60RF01 | BK | \$59.99



Fire/EMS Barrage™ Pack

Built to withstand years of wear and tear, the Fire/EMS Barrage features a 3-D mesh pack panel that helps increase ventilation and comfort for extended carry.

- Constructed of 1000 denier nylon with reinforced stitching
- Accommodates 100-oz. hydration reservoir (sold separately, see page 80)
- High-quality YKK® zippers and with yellow pull tabs and reflective cording
- Reflective gray piping for easy visibility
- Multiple rows of S.T.R.I.K.E.® webbing for attaching pouches or accessories
- 3-D mesh back panel
- External hydration reservoir access
- Removable, padded waist belt with additional S.T.R.I.K.E.® webbing
- Dual antenna ports
- Several internal pockets
- Hook & loop on front for ID patch
- Dimensions: 2000 cu. in./33 L (total), 18"L x 13"W x 6"D (main comp.), 13"L x 12.5"W x 2.5"D (front comp.)

65EB00 | BK, RD | \$199.99



Two removable internal pouches included (see below)



S.T.O.M.P. II™ Medical Coverage Pack (Jumpable)

Designed to SEAL team medic specifications, this heavy-duty medical pack is equipped with adjustable shoulder straps, sternum strap and web belt for comfortable carry—even under the weight of a full load.

- Constructed of 1000 denier nylon with reinforced stitching
- Breathable closed-cell foam padding
- Accommodates two 100-oz. hydration reservoirs (sold separately, see page 80)
- High-quality YKK® zippers with easy-grip pull tabs
- Webbing on underside for accessory packs or medic/sleeping rolls
- Adjustable shoulder straps, web belt and sternum strap
- Two robust grab handles
- Adjustable external compression straps accommodate various loadouts
- Metal grommet at bottom of pack for drainage
- Internal elastic stays and keepers
- External hook & loop strip
- Multiple small and medium pockets
- Drop pouches with rigging for jumps
- Several flat netted zipper pockets
- Includes S.T.O.M.P.™ Medical Pack Accessory Pouch with Red Handle and S.T.O.M.P. Medical Pack Accessory Pouch with Blue Handle (see below) for storing medical supplies
- Dimensions: 20"L x 13"W x 6"D = 2470 cu. in.

60MP01 | BK, OD, DE | NSN# 6545-01-522-4679 (BK), NSN# 6545-01-522-1031 (OD), NSN# 6545-01-522-1029 (DE) | \$334.99



First layer open



S.T.O.M.P.™ Medical Pack Accessory Pouch with Red Handle

This internal replacement pouch for the S.T.O.M.P. II Medical Coverage Pack (sold separately, see above) features a solid foam core for custom medical storage.

- Dimensions: 10"L x 5.25"W x 3.5"D = 185 cu. in.

60SAP1 | BK, OD, DE | \$26.99



S.T.O.M.P.™ Medical Pack Accessory Pouch with Blue Handle

This multifunctional pouch for the S.T.O.M.P. II Medical Coverage Pack (sold separately, see above) keeps medical supplies protected and secure thanks to multiple pockets and elastic stays.

- Dimensions: 12"L x 7"W x 3.25"D = 275 cu. in.

60SAP2 | BK, OD, DE | \$29.99



Two removable internal pouches included (see below)



Fire/EMS S.T.O.M.P. II™ Medical Coverage Pack (Jumpable)

The Fire/EMS S.T.O.M.P. II was designed to SEAL team medic specifications and adapted for the first responder. Its adjustable shoulder straps, sternum strap and web belt make for a comfortable fit while cinch straps maintain load integrity.

- Constructed of 1000 denier nylon with reinforced stitching
- Breathable closed-cell foam padding
- Accommodates two 100-oz. hydration reservoirs (sold separately, see page 80)
- Heavy-duty lockable YKK® zippers with yellow pull tabs and reflective cording
- Reflective gray piping for easy visibility
- Multiple rows of S.T.R.I.K.E.® webbing for attaching pouches or accessories
- Webbing on underside for accessory packs or medic/sleeping rolls
- Adjustable shoulder straps, web belt and sternum strap
- Two robust grab handles
- Adjustable external compression straps accommodate various loadouts
- Metal grommet at bottom of pack for drainage
- Internal elastic stays and keepers
- External hook & loop strip
- Multiple small and medium pockets
- Drop pouches with rigging for jumps
- Several flat netted zipper pockets
- Includes Fire/EMS S.T.O.M.P.™ Medical Pack Accessory Pouch with Red Handle and Fire/EMS S.T.O.M.P. Medical Pack Accessory Pouch with Blue Handle (see below) for storing medical supplies
- Dimensions: 20"L x 13"W x 6"D = 2470 cu. in.

60EM01 | BK, RD | \$339.99

Fire/EMS S.T.O.M.P.™ Medical Pack Accessory Pouch with Red Handle

This durable 1000 denier nylon replacement pouch for the Fire/EMS S.T.O.M.P. II Medical Coverage Pack (sold separately, see above) features a solid foam core for customized medical supply storage and a clear panel for ID placement. It's also equipped with reflective gray piping and yellow zipper pull tabs for easy visibility.

- Dimensions: 10"L x 3.5"W x 5.5"D = 192.5 cu. in.

60ES01 | BK, RD | \$29.99



Fire/EMS S.T.O.M.P.™ Medical Pack Accessory Pouch with Blue Handle

Constructed of 1000 denier nylon and featuring reflective gray piping, this internal accessory pouch for the Fire/EMS S.T.O.M.P. II Medical Coverage Pack (sold separately, see above) keeps your medical supplies organized in multiple pockets and elastic stays.

- Dimensions: 10"L x 3.5"W x 5.5"D = 192.5 cu. in.

60ES02 | BK, RD | \$35.99



Special Operations Medical Backpack

This mid-sized, frameless medical pack was designed with input from elite military medics with expertise in field trauma care. It opens fully to display all items for efficient emergency care and includes S.T.R.I.K.E.® webbing on three sides for modular gear attachment.

- Constructed of 1000 denier nylon with reinforced stitching
- Accommodates 100-oz. hydration reservoir (sold separately, see page 80)
- Heavy-duty lockable YKK® zippers with easy-grip pull tabs
- Contour-padded shoulder straps and waist belt (.5" padding)
- Robust grab handle
- Adjustable external compression straps accommodate various loadouts
- Metal grommet at bottom of pack for drainage
- Internal pockets made of urethane-coated mesh
- Individual medical gear compartments
- Padded back and internal tri-fold flap
- Dimensions: 18"L x 13"W x 7.5"D = 2225 cu. in.

60MP00 | BK, OD, DE | NSN# 6545-01-522-1016 (BK),
 NSN# 6545-01-522-1030 (OD), NSN# 6545-01-522-
 1017 (DE) | \$199.99



Supplies not included

M-7 Series Compact Medical Pack

The versatile M-7 Series Compact Medical Pack can be worn as a backpack or used as a carry bag for medical gear, travel gear or any other equipment.

- Constructed of 1000 denier nylon with reinforced stitching
- Includes 100-oz. BLACKHAWK!™ hydration reservoir (see page 80)
- Drink system protected by Microban® antimicrobial technology
- Bite Me® bite valve and patent-pending quick-disconnect system
- High-quality YKK® zippers and easy-grip pull tabs
- S.T.R.I.K.E.® webbing on back panel for attaching pouches or accessories
- IVS™ (Intercooler Venting System) back panel for ventilation
- Contoured, padded backpack straps
- Divided elastic straps on flap to secure small items
- Large hook & loop area on back panel for ID patches
- Two large contoured, covered side pockets for holding oxygen cylinders, IV bags, etc.
- Large zipper pocket on main compartment flap
- Large internal open-top, divided pocket
- Three 16"x 7" clear-view pockets
- One 8"x 16" clear-view pocket attached to top flap
- Internal elastic stays and clear-view pockets
- Dimensions: 16.5"L x 10"W x 7"D = 1800 cu. in.

60MP03 | BK | NSN# 6545-01-522-1022 | \$199.99



Internal elastic storage
 and clear-view pockets

RapidFlex™ Medical Litter

This robust medical litter is designed for medics who need to move injured personnel quickly. Compact and lightweight, it features an adjustable waist strap, four side handles and reinforced drag straps for one-person carry.

- Constructed of heavy-duty, impermeable PVC tarpaulin
- Rolls up into small bundle for easy storage and deployment
- Stabilizing torso strap is constructed of 2" nylon webbing and adjusts to 76" with side-release buckle
- Six durable 2" nylon web loop handles (two carry handles on each side and one drag handle at each end)
- Combined strength of all four handles exceeds 1700 lbs.
- Drag weight exceeds 1600 lbs.
- Dimensions: 4"D x 20"W (rolled), 20"W x 44"L (open)
- Weight: 2.25 lbs.

20ML00 | BK | \$48.99

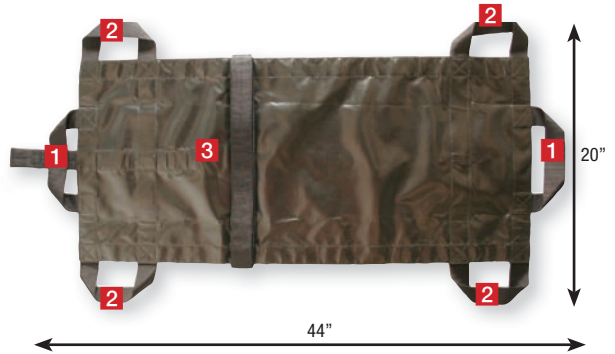

- 1 Reinforced top and bottom drag straps
- 2 Four side handles
- 3 Adjustable chest/waist straps
- 4 Adjustable leg straps

Fast Attack Tactical Litter

Use this sturdy tactical litter to move injured personnel safely—even through rough terrain and by only one person if necessary. The Fast Attack Tactical Litter incorporates adjustable leg and chest straps for maximum stability while four side handles and reinforced drag straps provide multiple carry options.

- Heavy-duty, impermeable PVC tarpaulin material
- Six durable 2" nylon web loop handles (two carry handles on each side and one drag handle at each end)
- Combined strength of all four handles exceeds 1900 lbs.
- Drag weight exceeds 1800 lbs.
- Stabilizing torso strap constructed of 2" nylon webbing and adjusts to 76" with side-release buckle
- Angled stabilizing leg straps constructed of 2" nylon webbing and adjust to 32" with side-release buckles
- Dimensions: 4.25"D x 29"W (rolled), 29"W x 55"L (open)
- Weight: 3.8 lbs.

20ML01 | BK | \$67.99



Medic Roll

Featuring 15 various sized clear pouches, this medical roll is a great way to organize and carry all your medical supplies. It rolls up into a compact rig and is secured by hook & loop and side-release buckles.

- Constructed of durable 1000 denier nylon
- Full wraparound carry handles for superior weight support
- Internal pleated vinyl pockets to store medical supplies
- Accessory hooks for hanging from stretcher or gurney (20EM03 only)
- External swivels for attachment to other bags (20EM03 only)
- Reflective gray piping for easy visibility (20EM03 only)
- Dimensions: 37"L x 13.5"W (open)

Medic Roll | 20EMR1 | BK | \$44.99

Fire/EMS Medic Roll | 20EM03 | BK, RD | \$49.99



Hydration

Microban® antimicrobial protection is built directly into each BLACKHAWK!™ hydration reservoir, so you don't have to worry about it washing off or wearing away after extensive use. When microbes such as bacteria, mold or mildew come in contact with the product's surface, the Microban technology penetrates the microbes' cell walls, disrupting key cell functions so they can no longer function, grow or reproduce.* And the result? Your drinking water stays clean and bacteria-free!

*This information is based on standard laboratory tests and is provided for comparative purposes to substantiate antimicrobial activity of non-public health applications. Antimicrobial action is limited to product surface.



Initial Response Hydration Pack

This low-profile pack minimizes unnecessary bulk and weight while letting you carry a 100-oz. hydration reservoir for quick access while on the job.

- Includes 100-oz. BLACKHAWK!™ hydration reservoir
- Constructed of 1000 denier nylon with reinforced stitching
- Requires Initial Response Web Belt (sold separately, see page 85)
- High-quality zippers with yellow pull tabs
- Reflective gray piping for easy visibility
- Hook & loop panel on front

65RP01 | BK | \$129.99



Turbine™ Pack

The Turbine is the workhorse of hydration systems, featuring a streamlined design that can be easily integrated into any BLACKHAWK!® vest, pack or bag.

- Includes 100-oz. BLACKHAWK!™ hydration reservoir
- Drink system protected by Microban® antimicrobial technology
- Bite Me® bite valve and patent-pending quick-disconnect system
- Contoured, padded shoulder strap with adjustable quick-ditch buckles
- High-quality YKK® zippers with easy-grip pull tabs
- Internal moisture-wicking mesh and thermo-insulating padding
- Capacity: 100 oz./3 L

65TU00 | BK | NSN# 8456-01-520-6185 | \$69.99



Tidal Rave™ Pack

The compact Tidal Rave is an economical hydration system designed for basic outings.

- Includes 100-oz. BLACKHAWK!™ hydration reservoir
- Drink system protected by Microban® antimicrobial technology
- Bite Me® bite valve and patent-pending quick-disconnect system
- Lightweight mesh shoulder harness
- Bungee retention system for extra clothes storage
- Capacity: 100 oz./3 L
- Weight: 14.1 oz.

65TR00 | BK | \$49.99

S.T.R.I.K.E.® Predator™ Pack

With 750 cubic inches of internal storage space, the S.T.R.I.K.E. Predator offers big capacity while conveniently accommodating modular BLACKHAWK!® accessory attachments.

- Constructed of 1000 denier nylon with reinforced stitching
- Includes 100-oz. BLACKHAWK!™ hydration reservoir
- Drink system protected by Microban® antimicrobial technology
- Bite Me® bite valve and patent-pending quick-disconnect system
- High-quality YKK® zippers and easy-grip pull tabs
- Multiple rows of S.T.R.I.K.E.® webbing for attaching pouches or accessories
- Padded, contour-fit shoulder harness with sternum strap
- Reinforced drag/carry handle
- IVS™ (Intercooler Venting System) back panel for ventilation
- Compartment for second optional hydration reservoir (sold separately, see page 80)
- Dimensions: 750 cu. in./12 L (total), 16"L x 9.5"W x 2.5"D (main comp.), 9"L x 9.5"W x 2.5"D (front comp.)
- Capacity: 100 oz./3 L

65SP00 | BK, CT | \$119.99



Fun Fact: The Bite Me® bite valve system gives you a 360-degree bite zone for easy hydration while an ergonomic on/off lever lets you control the flow. Learn more on page 80!

S.T.R.I.K.E.® Cyclone™ Pack

This versatile, rugged backpack is NTOA reviewed and approved and has quickly become a customer favorite!

- Constructed of 1000 denier nylon with reinforced stitching
- Includes 100-oz. BLACKHAWK!™ hydration reservoir
- Drink system protected by Microban® antimicrobial technology
- Bite Me® bite valve and patent-pending quick-disconnect system
- High-quality YKK® zippers and easy-grip pull tabs
- Multiple rows of S.T.R.I.K.E.® webbing for attaching pouches or accessories
- Tube cover conceals, insulates and protects water tube from sunlight
- Anodized D-rings and quick-cinch buckles for attaching pouches
- Reinforced waist belt with additional attachment points
- Padded, contour-fit shoulder straps with sternum strap
- Rubber drag handle
- Metal grommet at bottom of pack for drainage
- Large compartment with internal pouch for radio packs and three antenna ports with flaps
- Dimensions: 1800 cu. in. / 32 L (total), 19"L x 11"W x 5.5"D (main comp.), 9.5"L x 7"W x 3"D (front top comp.), 11"L x 11.5"W x 3.5"D (front bottom comp.)
- Capacity: 100 oz./3 L

65SC00 | BK, CT, OD, FG, MC | NSN# 8465-01-522-1025 (OD), NSN# 8465-01-522-1026 (CT) | \$175.99 (MC = \$239.99)





Barrage™ Pack

The Barrage is the 3-Day Assault Pack on steroids! We've incorporated a 3-D mesh back panel for increased airflow and a robust waist belt for added stability.

- Constructed of 1000 denier nylon with reinforced stitching
- Includes 100-oz. BLACKHAWK!™ hydration reservoir
- Drink system protected by Microban® antimicrobial technology
- Bite Me® bite valve and patent-pending quick-disconnect system
- High-quality YKK® zippers and easy-grip pull tabs
- Multiple rows of S.T.R.I.K.E.® webbing for attaching pouches or accessories
- Wide opening for easy access to contents
- 3-D mesh back panel with frame
- External hydration reservoir access
- Robust waist belt with additional S.T.R.I.K.E.® attachment points
- Dual antenna ports
- Several internal pockets and dividers
- Dimensions: 2000 cu. in./33 L (total), 17L" x 13"W x 7"D (main comp.), 13"L x 12.5"W x 2.75"D (front comp.)

65BG00 | BK, CT, OD | \$199.99



Titan™ Pack

This large, functional pack comes with two of our best-selling pouches that can be used as is or changed out with other pouches as needed.

- Constructed of heavy-duty 1000 denier nylon with reinforced stitching
- Includes 100-oz. BLACKHAWK!™ hydration reservoir
- Drink system protected by Microban® antimicrobial technology
- Bite Me® bite valve and patent-pending quick-disconnect system
- High-quality YKK® zippers and easy-grip pull tabs
- Multiple rows of S.T.R.I.K.E.® webbing for attaching pouches or accessories
- 3-D mesh back panel with frame
- Robust waist belt with additional S.T.R.I.K.E.® webbing
- Dual antenna ports
- External hydration reservoir access
- Tie-down straps in main compartment
- Reinforced attachment system
- Includes Upright GP Pouch and Nalgene® Bottle Pouch (see page 199)
- Dimensions: 2800 cu. in./40 L (total), 20"L x 12.5"W x 7.5"D (main comp.), 14"L x 12.5"W x 2.75"D (top front comp.), 12.5"L x 6"W x 3"D (bottom front comp.), 8.25"L x 5"W x 3.75"D (side comp.), 9"L x 4"W x 2"D (side comp.)

65TI00 | BK, CT, OD, MC | \$259.99 (MC = \$299.99)





Side Hydration Pouch

This hydration pouch holds up to 40 ounces of liquid for missions where you don't need to lug around excess weight.

- Mount on side, back, front or backpack using Speed Clips™ (sold separately, see page 214)
- Drink system protected by Microban® antimicrobial technology
- Bite Me® bite valve and patent-pending quick-disconnect system
- Capacity: 40 oz./1 L

65SH00 | BK, CT, AU | \$59.99



Antimicrobial Hydration Reservoir Kit

Featuring Microban® antimicrobial technology, our hydration reservoir with 40" delivery tube inhibits the growth of bacteria, mold and mildew for worry-free consumption. It also includes a unique Bite Me® bite valve with on/off lever.

100-oz. Standard OEM Reservoir | 672556 | BK, CT, FG | \$38.99

40-oz. Reservoir | 672540 | BK, CT, FG | \$33.99

Quick Tip: Use the 40-oz. Antimicrobial Hydration Reservoir as a replacement for the Side Hydration Pouch (see above) or add it to other pouches as a backup reservoir.



360-degree Bite Me® Bite Valve

Hydration Reservoir Bite Me® Bite Valve

This replacement Bite Me bite valve system gives you a 360-degree bite zone for easy hydration while an ergonomic on/off lever lets you control the flow.

- Excellent flow rate
- Locking 360-degree rotating connector for bite valve removal from drink tube
- Simple, ergonomic on/off lever

67255300 | Black | \$10.99

for more: [YouTube™](https://www.youtube.com/bpggear)
youtube.com/bpggear

CQB/Rigger's Belt NEW COLOR!

A longtime bestseller at BLACKHAWK!®, the CQB/Rigger's Belt is MIL-standard certified and built with parachute-grade buckles and adapters for unparalleled strength and support.

- 1.75" webbing
- 7,000-lb. tensile strength (solid colors) or 5,000-lb. tensile strength (MultiCam®)
- Hook & loop secures running end

Up to 34" | 41CQ00 | BK, OD, DE, DB, MC | NSN# 4240-01-519-2622 (BK), NSN# 4240-01-586-2392 (DE) | \$34.99 (MC = \$45.99)

Up to 41" | 41CQ01 | BK, OD, DE, DB, MC | NSN# 4240-01-509-6087 (BK), NSN# 4240-01-529-7437 (DE) | \$36.99 (MC = \$47.99)

41" – 51" | 41CQ02 | BK, OD, DE, DB, MC | NSN# 4240-01-509-6086 (BK), NSN# 4240-01-519-2779 (OD), NSN# 4240-01-560-6022 (DE) | \$39.99 (MC = \$49.99)

**Fire/EMS Belt with 1" Reflective Strip**

Incorporating all the high-performance features found in our CQB/Rigger's Belt, this fire/EMS model is designed with the first responder in mind. It's equipped with a removable, hook & loop-secured reflective strip for easy visibility in low-light conditions.

- 1.75" webbing
- 9,000-lb. tensile strength
- Hook & loop secures running end
- Removable 1" reflective strip with cut lines to adjust to user's size

Small (Up to 34") | 41EB00 | BK | \$39.99

Medium (Up to 41") | 41EB01 | BK | \$44.99

Large (41" – 51") | 41EB02 | BK | \$44.99

**Replacement Reflective Strip**

- 24"L X 1"W with hook & loop backing

41RS00 | GY | \$6.99

Instructor's Gun Belt – 1.5" NEW COLOR!

The Instructor's Gun Belt gives you the added benefit of a polyethylene spine to help bear the weight of your belt-mounted holster and heavy equipment. Whether you wear it with jeans or khakis, for casual or duty carry, this belt is designed to offer extreme support.

- Parachute-grade buckles and adapters meet PIA-H-7195 standards
- 1.5" webbing
- 7,000-lb. tensile strength (solid colors) or 4,000-lb. tensile strength (MultiCam®)
- Hook & loop secures running end

Up to 34" | 41VT10 | BK, MC | \$49.99

Up to 41" | 41VT11 | BK, MC | \$49.99

41" – 51" | 41VT12 | BK, MC | \$49.99



Instructor's Gun Belt – 1.75"

The Instructor's Gun Belt answers the demands for a rigid CQB/pistol belt with its tough 1.75" webbing and Kydex® stiffener for superior holster and equipment support.

- Parachute-grade buckles and adapters meet PIA-H-7195 standards
- 1.75" webbing
- 7,000-lb. tensile strength
- Kydex® stiffener supports gun holsters and equipment
- Hook & loop secures running end

34" – 41" | 41VT01 | BK | \$43.99
 42" – 52" | 41VT02 | BK | \$46.99



CQC® Pistol Belts IMPROVED PERFORMANCE!

Our new and improved CQC Pistol Belts boast a more durable, comfortable design, combining premium materials with a polymer reinforcement spine. Get the same classic appearance of an ordinary dress belt in a package that offers a stable platform for carrying a handgun, spare mags or handcuffs.

- Polymer reinforcement spine
- Flexible PVC core for comfort and improved performance
- Durable non-woven nylon resists fading and abrasion
- Solid metal buckles and hardware

1.5" Plain Black with Brushed Nickel Buckle | 4113 -PBK | 28" – 48" Even Waist | \$34.99

1.5" Brown Gator with Antique Brass Buckle | 4113 -GBN | 28" – 48" Even Waist | \$34.99

1.5" Black Gator with Brushed Nickel Buckle | 4113 -GBK | 28" – 48" Even Waist | \$34.99

1.25" Black Carbon Fiber with Brushed Nickel Buckle | 4113 -CBK | 28" – 48" Even Waist | \$34.99

1.5" Plain Black

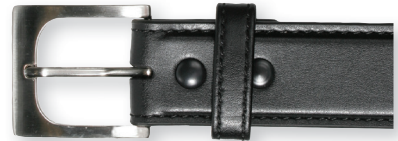

1.5" Brown Gator



1.5" Black Gator



1.25" Black Carbon Fiber



Universal BDU Belt

- Lightweight 1.75" wide belt with metal friction buckle
- One size fits all (up to 52")

41UB01 | BK, OD, DE, DB | NSN# 8465-01-522-2570 (BK), NSN# 8465-01-522-2569 (OD), NSN# 8465-01-522-2567 (DE) | \$11.99



Military Web Belt (Modernized)

- 2.25" wide belt with side-release buckles for quick-on/quick-off (no heavy metal hardware)
- Hook & loop size adjustment
- Top choice among the military

Large (Up to 43") | 41WB02 | BK, OD, FG, DE | NSN# 8465-01-529-7434 (BK), NSN# 8465-01-529-7435 (OD), NSN# 8465-01-529-7436 (DE) | \$27.99

X-Large (44" – 49") | 41WB03 | BK, OD, FG, DE | NSN# 8465-01-545-5740 (BK), NSN# 8465-01-545-5741 (OD) | \$28.99

Belt Extender

- Expands girth of Military Web Belt (sold separately, see page 82) when wearing vest or jacket
- Patented three-point release buckle

41WBE2 | BK, OD | NSN# 8465-01-529-5684 (BK) | \$11.99



Horizontal Mount



Vertical Mount



Enhanced Patrol Belt Pad

- Closed-cell foam padding will not absorb moisture
- 3-D mesh for comfort and ventilation
- Fits belts up to 2.75" wide
- Two rows of S.T.R.I.K.E.® webbing for attaching pouches or accessories
- Convenient openings help guide belt through pad
- Non-slip lining keeps pad in place
- Accommodates Military Web Belt (sold separately, see page 82)

Small (36" L x 5.25" W) | 41PB00 | CT, MC | \$33.99 (MC = \$46.99)
 Medium (39.5" L x 5.25" W) | 41PB01 | CT, MC | \$36.99 (MC = \$50.99)
 Large (42.5" L x 5.25" W) | 41PB02 | CT, MC | \$36.99 (MC = \$54.99)



S.T.R.I.K.E.® Reversible Modular Belt Panels

- Allows you to wear PALS/MOLLE-compatible pouches with any belt
- Reversible design supports vertical or horizontal mount
- Various sizes allow for different lengths
- Fits belts up to 2.5" wide

12" Panel | 41PL12 | BK, CT, OD, FG | \$14.99
 18" Panel | 41PL18 | BK, CT, OD, FG | \$19.99 **WHILE SUPPLIES LAST**
 24" Panel | 41PL24 | BK, CT, OD, FG | \$24.99 **WHILE SUPPLIES LAST**
 30" Panel | 41PL30 | BK, CT, OD, FG | \$29.99 **WHILE SUPPLIES LAST**



Belt Pad with IVS™

- Constructed of 1000 denier nylon
- .375" closed-cell foam padding will not absorb moisture or perspiration
- Belt keepers fit belts up to a 2.25" wide

Small (28" – 34") | 41BP00 | BK, OD | \$20.99
 Medium (36" – 40") | 41BP02 | BK, OD | \$21.99
 Large (42" – 48") | 41BP03 | BK, OD | \$24.99



Padded Patrol Belt with IVS™

- Closed-cell foam will not absorb moisture or perspiration
- S.T.R.I.K.E.® webbing for attaching pouches or accessories
- Secured by 2.25" side-release buckle with adjustment pull tabs

X-Small (32.5" – 42") | 41PBT0 | DE | \$35.99
 Small (37" – 43") | 41PBT1 | DE | NSN# 8465-01-562-3120 | \$37.99
 Medium (43" – 49") | 41PBT2 | DE | \$39.99
 Large (46" – 52") | 41PBT3 | DE | NSN# 8465-01-562-3119 | \$41.99



Handgun



2" Web Duty Belt

- Double-layer nylon web design
- Nylon binding for smooth edge, comfort and professional appearance
- Triple-retention buckle and molded keepers for tough use

44B6 | SM – XL | BK | NSN# 8415-01-504-3086 (MD), NSN# 8415-01-504-3068 (LG) | \$21.99



2.25" Ergonomic Padded Duty Belt

- Constructed of molded CORDURA®
- Ergonomically designed with padded edges
- Triple-retention buckle
- Nylon loop backing mates up to Inner Trouser Belt (sold separately, see page 85)

44B2 | SM – XL | BK | \$36.99



Rifle



Shotgun



Reinforced 2" Web Duty Belt

- Double-layer nylon web design with polymer spine reinforcement
- Nylon binding for smooth edge, comfort and professional appearance
- Triple-retention buckle and molded keepers for tough use

44B3 | SM – XL | BK | \$27.99



Loopback Inner Duty Belt

- Comfortable, easy-to-use design
- Low-profile, nylon loopback buckle for easy size adjustment
- Woven nylon hook mates up to nylon loop on inside of duty belt (sold separately, see page 84 – 85)
- Reversible for courtroom wear

44B5 | XS – XL | BK | \$14.99

Cartridge Belt

- Durable buckles and nylon construction
- Universal cartridge belts fit up to 50" waist

Handgun Cartridge | 74BC00 | BK | \$20.99
Shotgun Cartridge | 74BC02 | BK | \$20.99
Rifle Cartridge | 74BC01 | BK | \$20.99



2.25" Academy/Demo Belt

- Designed to support heavy pistols and equipment
- Ideal for defense tactics classes and handgun courses
- Fully adjustable, reinforced, hook & loop-secured 61.5" long demo belt
- One size fits all

44BU00 | BK | \$29.99

Trying to find the right belt size? Refer to these measurements to help you make the best choice:

X-Small (XS) 22" – 24"
Small (SM) 26" – 30"
Medium (MD) 32" – 36"
Large (LG) 38" – 42"
X-Large (XL) 44" – 48"
2X-Large (2XL) 50" – 54"



Hook & Loop Inner Duty Belt

- Nylon hook & loop closure
- Woven nylon hook mates up to nylon loop on inside of duty belt (sold separately, see page 84 – 85)

44B7 | SM – XL | BK | \$12.99



Inner Trouser Belt

- Molded nylon hook won't fray belt loops or trousers
- Woven nylon hook mates up to nylon loop on inside of duty belt (sold separately, see page 84 – 85)
- Reversible for courtroom wear

44B1 | SM – XL | BK | \$21.99



Reinforced 2" Duty Belt with Loop Inner

- Nylon hook inner surface mates up to nylon hook in BLACKHAWK!® inner duty belts (sold separately, see page 84 – 85)

Webbing | 44B4 | SM – 2XL | BK | \$29.99
 Basketweave | 44B4 | SM – 2XL | BW | \$49.99
 Plain | 44B4 | SM – 2XL | PL | \$49.99

Check out our full line of traditional and molded duty gear on page 89 – 93!



Ergonomic Duty Belt Harness

Ease the load of your duty belt to help prevent back and hip injury with the Ergonomic Duty Belt Harness. Let us shoulder some of the burden with this proven harness system.

- Broad fit range
- No moving parts to fail
- NIJ selected and funded to address back and hip pain
- Helps alleviate discomfort caused by heavy duty belts
- Eliminates issues associated with external suspender systems
- Can be worn under duty shirt with slight modifications
- Compatible with most concealment armor packages
- Accommodates duty belts up to 2.25" wide (sold separately, see page 84)

SM/MD | 44H001 | BK | \$79.99
 LG/XL/2XL | 44H002 | BK | \$79.99



Initial Response Web Belt

- Wide padded 3-D mesh lumbar support
- Can be worn alone or with other Initial Response gear (sold separately, see page 72, 77, 172 and 260)
- S.T.R.I.K.E.® webbing for attaching pouches or accessories
- Dual-adjust buckle
- Reflective gray piping

41RB01 | BK | \$46.99

Split Front Chest Rig **NEW!**

- Constructed of 500 denier ripstop (solid colors) or CORDURA® nylon (MultiCam®)
- Closed-cell foam padding in shoulder straps for superior comfort
- Split front with heavy-duty zipper closure for easy on/off capability
- Adjustable padded shoulder straps
- Adjustable "H" back harness to fit any size operator
- Multiple rows of S.T.R.I.K.E.® webbing for attaching pouches or accessories
- Three antenna/hydration tube sleeves on each shoulder
- Two internal mesh pockets providing either top or side access (10.5" x 6.5")
- Removable waist belt
- Dimensions: 24.4"L x 7.28"W x 0.39"D
- Weight: 1.27 lbs.

55SF00 | BK, CT, OD, MC | \$89.99 (MC = \$109.99)



LRAK M240/SAW Gunner Kit

- Two 100-round 240 pouches (also fits 200-round SAW box)
- Two 200-round 7.62 pouches (also fits 200-round SAW box)
- Two 1-qt. canteen pouches
- Two pop flare pouches
- One gunner tool pouch (knife, multi-tool, etc.)
- One strobe/compass pouch
- One enhanced butt pack
- One flashlight pouch
- S.T.R.I.K.E.® webbing on shoulders for attaching pouches or accessories
- Elastic retention strap for fins or slung rifle

30HH03 | OD | NSN# 8415-01-563-3973 | \$299.99



Commando Chest Harness

- Constructed of durable 1000 denier nylon
- Adjustable, padded cross straps with .25" closed-cell foam for comfort
- Adjustable quick-release waist strap
- Four ammo pouches hold two AK-47, three M16 or two M14 magazines each
- Pouch dividers prevent magazine clatter and enhance noise discipline
- Two end utility pouches hold radios, rations, compasses, etc.
- Large internal utility/map pouch with securing flap
- Belt loops secure vest to any web belt (sold separately, see page 81 – 85)
- Patent # D488,614

55CO00 | BK, OD, DE, AU | \$144.99



Modular Low-Profile Chest Rig

- Elastic pull-tab retainers hold six M16/M4 magazines in open-pouch configuration
- S.T.R.I.K.E.® webbing for attaching pouches or accessories

55CR01 | AU | \$89.99



Chest Magazine Pouch

- Constructed of durable, lightweight 500 denier ripstop and Type 4 nylon webbing
- One size fits all with adjustable shoulder and waist straps
- Holds eight rifle magazines and two pistol magazines
- Pouches include grommets for drainage
- Hook & loop lid closures
- Patent # D488,614
- Dimensions (55CP01): 3.5"L x 6.875"W x 1.25"D (mag pockets), 3.5"L x 6.875"W x 1.5"D (main pockets), 19.75"W x 9"H (area)
- Dimensions (55CP04): 1.875"L x 6.375"W x 1.25"D (mag pockets), 3"L x 6.375"W x 2.25"D (main pockets), 17.25"W x 8.375"H (area)
- Weight: 1 lb. 5 oz.

M16/M4 | 55CP01 | BK, DE | \$69.99
 AK-47 | 55CP04 | CT | \$69.99



Rifle Bandoleer

- Holds six M16/M4 magazines
- Perfect for first responders or active shooters
- Ambidextrous shoulder rig with non-slip pad
- Stabilizing quick-release waist strap

55SOS1 | BK | \$59.99



Rifle/Pistol Bandoleer

- Holds four rifle magazines and two pistol magazines
- Cross-torso/shoulder-carried bandoleer
- Quick-release buckle for fast removal
- Padded back panel for comfort
- Two belt keepers on back panel secure around belt by snap fasteners
- Two M16/M4 adjustable flap mag pouches with silencing dividers in center
- Pistol mag pouches with adjustable flaps
- D-rings at bottom corners for securing to waist belt (not included)
- Dimensions: 11.5"W x 6.5"H

55RB01 | BK | \$44.99



Shotgun Bandoleer

- Holds 55 shotgun shells
- Constructed of high-quality 2.25" military pistol belt nylon webbing and heavy-duty 1.5" elastic to keep shells secure
- Weight: 5 oz.

43SB55 | BK | \$29.99



U.S.A.R. Radio Chest Harness

- Perfect for mounted or dismounted ops where having an easy-access radio, GPS, knife and second mag is critical
- Internal pouch for maps and documents
- Adjustable for all portable radio sizes
- Quick-release buckles
- Elastic antenna support
- Reflective gray piping

55US00 | BK, RD | \$50.99



Patrol Radio Harness

- Holds radios and other small hardware
- Perfect for mounted or dismounted ops where having an easy-access radio, GPS, knife and second mag is critical
- Internal pouch for maps and documents
- Adjustable for all portable radio sizes
- Quick-release buckles
- Elastic antenna support

37PRH1 | BK | \$49.99

Molded Duty Gear

BLACKHAWK!® has done it again, giving you the best of both worlds—traditional-looking yet street-tough duty gear. Our molded duty gear combines the lightweight, high-performance, disinfecting properties of nylon with a classic molded look. Both the Basketweave and Plain Finish Molded Duty Gear feature a traditional leather appearance while the Molded CORDURA® Duty Gear gives you all the benefits of tough, abrasion-resistant CORDURA® nylon. No matter which you choose, you'll get the strength of a proprietary five-layer laminate system with an integral polymer core for long-lasting service life.



See our full line of duty belts on page 84 – 85!

Basketweave Molded Duty Gear

1. Chem Agent Medium (MK3) | 44A500BW | \$29.99
2. Silent Key Holder | 44A600BW | \$23.99
3. Latex Glove Pouch | 44A300BW | \$23.99
4. Handcuff Pouch Single | 44A100BW | \$31.99
5. Double Mag Pouch Staggered Column (Glock 21) | 44A002BW | \$42.99
6. Double Mag Pouch Single Column | 44A000BW | \$42.99
7. Light/Baton Holder (D-Cell/C-Cell) | 44A201BK | \$8.99
8. Molded Belt Keepers (Set of 4) | 44B300BW | \$15.99
9. Expandable Baton Carrier | 44A700BW | \$24.99
10. Radio Pouch | 44A400BW | \$44.99
11. Chem Agent Large (MK4) | 44A501BW | \$29.99
12. Stinger™ Light Pouch | 44A203BW | \$34.99
13. Gladius® Light Pouch | 44A202BW | \$34.99
14. Light Pouch 6P/6R/TL-2/TT-2/M-6 | 44A200BW | \$29.99
15. Single Mag Pouch (Double Row) | 44A003BW | \$25.99
16. Double Mag Pouch Staggered Column | 44A001BW | \$42.99
17. Chem Agent Punch II Canister Pouch | 44A502BW | \$33.99
18. Double Handcuff Case | 44A101BW | \$39.99
19. Reinforced 2" Duty Belt with Loop Inner | 44B4 | SM – 2XL | BW | \$49.99

Note: See more duty belts on page 84 – 85.



Plain Finish Molded Duty Gear

1. Chem Agent Punch II Canister Pouch | 44A502PL | \$33.99
 2. Silent Key Holder | 44A600PL | \$23.99
 3. Latex Glove Pouch | 44A300PL | \$23.99
 4. Handcuff Pouch Single | 44A100PL | \$31.99
 5. Double Mag Pouch (Double Row) | 44A001PL | \$42.99
 6. Double Mag Pouch (Single Row) | 44A000PL | \$42.99
 7. Light/Baton Holder (D-Cell/C-Cell) | 44A201BK | \$8.99
 8. Molded Belt Keepers (Set of 4) | 44B300BW | \$15.99
 9. Expandable Baton Carrier | 44A700PL | \$24.99
 10. Radio Pouch | 44A400PL | \$44.99
 11. Stinger™ Light Pouch | 44A203PL | \$34.99
 12. Chem Agent Large (MK4) | 44A501PL | \$29.99
 13. Gladius® Light Pouch | 44A202PL | \$34.99
 14. Light Pouch 6P/6R/TL-2/TT-2/M-6 | 44A200PL | \$29.99
 15. Single Mag Pouch (Double Row) | 44A003PL | \$25.99
 16. Double Mag Pouch Staggered Column (Glock 21) | 44A002PL | \$42.99
 17. Chem Agent Medium (MK3) | 44A500PL | \$29.99
 18. Double Handcuff Pouch | 44A101PL | \$39.99
 19. Reinforced 2" Duty Belt with Loop Inner | 44B4 | SM - 2XL | PL | \$49.99
- Note: See more duty belts on page 84 - 85.

Fun Fact: Our mag pouches can be adjusted to work in either the vertical or horizontal position.



Molded CORDURA® Duty Gear

- 1. Single Mag Pouch | 44A003BK | \$23.99
 - 2. Silent Key Holder | 44A600BK | \$16.99
 - 3. Latex Glove Pouch | 44A300BK | \$18.99
 - 4. Handcuff Pouch Single | 44A100BK | \$23.99
 - 5. Double Mag Pouch (Double Row) | 44A001BK | \$34.99
 - 6. Double Mag Pouch (Single Row) | 44A000BK | \$33.99
 - 7. Molded Belt Keepers (Set of 4) | 44B300BK | \$13.99
 - 8. Light/Baton Holder (D-Cell/C-Cell) | 44A201BK | \$8.99
 - 9. TASER® Cartridge Holder | 44A800BK | \$24.99
 - 10. Expandable Baton Carrier | 44A700BK | \$18.99
 - 11. Radio Carrier with Quick-Disconnect Swivel Belt Loop | 44A400BK | \$37.99
 - 12. Chem Agent Large (MK4) | 44A501BK | \$24.99
 - 13. Stinger™ Light Pouch | 44A203BK | \$31.99
 - 14. Gladius® Light Pouch | 44A202BK | \$24.99
 - 15. Chem Agent Medium (MK3) | 44A500BK | \$21.99
 - 16. Double Mag Pouch Staggered Column (Glock 21) | 44A002BK | \$35.99
 - 17. Light Pouch 6P/6R/TL-2/TT-2/M-6 | 44A200BK | \$21.99
 - 18. Chem Agent Punch II Canister Pouch | 44A502BK | \$30.99
 - 19. Double Handcuff Pouch | 44A101BK | \$29.99
 - 20. Ergonomic Padded Duty Belt | 44B2 | SM – XL | BK | \$36.99
- Note: See more duty belts on page 84 – 85.



Did you know? All narrow accessory and light pouches can be mounted to our SERPA® Tactical Holster platforms (see page 126 and 128) and Modular Drop-Leg Platform (see page 250).



*See our full line of
duty belts on page 84
– 85!*

Traditional-Style Nylon Duty Gear

Our traditional non-molded duty gear is constructed of durable, abrasion-resistant, easy-care CORDURA® nylon. We've combined this exclusive four-layer laminate CORDURA nylon with waterproof closed-cell foam padding, flexible polymer reinforcement and 150 denier knit lining to give you years of service at a price that fits any budget. To complete the package, we've also incorporated sturdy injection-molded belt loops to fit duty belts up to 2.25" wide.

- | | |
|---|---|
| 1. Open Cuff Case 44A150BK \$15.99 | 14. Nylon Belt Keepers Fit 2" Belts (Set of 4) 44B350BK \$12.99 |
| 2. Flat Cuff Case 44A151BK \$12.99 | 15. Nylon Belt Keepers Fit 2.25" Belts (Set of 4) 44B351BK \$12.99 |
| 3. Single Cuff Case 44A153BK \$17.99 | 16. Microphone Carrier for Epaulet 44A455BK \$9.99 |
| 4. Double Cuff Case 44A152BK \$21.99 | 17. TASER® Cartridge Holder 44A850BK \$16.99 |
| 5. Stinger™ Light Case 44A251BK \$16.99 | 18. Expandable Baton Case 44A750BK \$16.99 |
| 6. Large-Frame Glock Double Mag Case with Insert 44A053BK \$30.99 | 19. Open Key Holder 44A651BK \$11.99 |
| 7. Single Magazine Case (Single Row) 44A050BK \$19.99 | 20. Latex Glove Case (Holds 1 Pair) 44A350BK \$10.99 |
| 8. Single Magazine Case (Double Row) 44A051BK \$19.99 | 21. Latex Glove Case (Holds 2 Pairs) 44A351BK \$14.99 |
| 9. Magazine/Folding Knife Case 44A058BK \$15.99 | 22. Large Glock Mag/Knife Case 44A052BK \$15.99 |
| 10. Universal Radio Carrier (Fixed Belt Loop) 44A450BK \$27.99 | 23. Mini Light Case with Flap 74LC03BK \$14.99 |
| 11. Universal Radio Carrier (Swivel Belt Loop) 44A451BK \$37.99 | 24. Universal Mag/Knife Case 44A055BK NSN# 8465-01-520-5916 \$14.99 |
| 12. Universal Double Mag Case 44A054BK \$22.99 | |
| 13. Silent Key Holder 44A650BK \$13.99 | |

(Continued on next page)

Traditional-Style Nylon Duty Gear (continued)

- 25. Divided Pistol Mag Case with Inserts (Single Row Mags) | 44A056BK | \$24.99
- 25. Divided Pistol Mag Case with Inserts (Double Row Mags) | 44A057BK | \$24.99
- 26. Stinger™ XT Light Case | 44A252BK | \$16.99
- 27. SureFire® 6P Light Case | 44A250BK | \$15.99
- 28. Chemical Agent Cases Medium (MK3) | 44A551BK | \$16.99
- 29. Chemical Agent Cases Large (MK4) | 44A550BK | \$17.99
- 30. Axon Belt Pouch | 44A410BK | \$21.99
- 31. Axon Flip Open Pouch | 44A411BK | \$40.99
- 32. Reinforced 2" Web Duty Belt with Loop Inner | 44B4 | BK | SM – 2XL | \$29.99

Note: See more duty belts on page 84 – 85.



Traditional-Style Nylon Duty Gear Combo Kit **NEW!**

We've packed big value into our line of non-molded, traditional-style CORDURA® duty gear by offering a pre-packaged kit. The kit includes everything you need for a complete duty rig.

- One (1) 2" Web Duty Belt (44B6)
- One (1) Expandable Baton Case (44A750BK)
- One (1) Set of Four (4) Nylon Belt Keepers for 2.25" Belts (44B351BK)
- One (1) Chemical Agent Case (44A551BK)
- One (1) Silent Key Holder (44A650BK)
- One (1) Universal Radio Case (44A450BK)
- One (1) Single Cuff Case (44A153BK)
- One (1) Stinger™ Light Case (44A251BK)
- One (1) Latex Glove Case (44A351BK)
- Cases constructed of thermo-bonded four-layer laminate with 1000 denier CORDURA® nylon
- Belt constructed of durable nylon web with three-point locking buckle
- Injection-molded belt loop fits belts up to 2.25" wide (cases only)
- 2" Web Duty Belt with Loop Inner (44B6) available in SM, MD, LG or XL (see page 84)

44AK10 | BK | SM – XL | \$129.99

Look for our Ergonomic Duty Belt Harness and full line of duty belts on page 84 – 85!



Dynamic Entry®

With increasingly tighter budgets and the ever-present threat of active shooter call-outs, we have remained focused on providing the most effective and cost-efficient manual entry equipment available. But we know that cost is not the only factor affecting agencies. Tightening space requirements necessitate smaller tools that can still get the job done.

The Dynamic Entry Mini Deployment Kit gives operators a bolt cutter, sledge and pry bar—all secured in a compact carry bag that weighs only 16 pounds and can easily be stored in the trunk of a patrol or rescue vehicle. Another compact, budget-conscious tool choice is the newly redesigned Breaching Sledge. Weighing only eight pounds and measuring 22 inches in length, the Breaching Sledge features micro-metals for reduced spalling, a sure-grip handle system to help eliminate slippage and counter-angled friction ridges on the wedge for added grip and stability during breaching.

With Dynamic Entry, Nothing Shall Stand in your Way®.



Collapsible Tool Series

Combining years of research and development with input from operators in the field, the groundbreaking Dynamic Entry® Collapsible Tool Series exceeds our legendary durability standards. At the heart of this revolutionary design are the following standard features:

- Compact collapsible design for close-quarter operations and easy transport
- Extended shafts for more strike power, pry leverage and breaching force
- Epoxied fiberglass core surrounded by two interlocking stainless steel shafts
- Dual-locking mechanism secures shafts when extended
- Handgrip provides secure grip in extreme weather conditions and protects locking mechanism from dirt or debris



Dynamic Entry® Collapsible Breacher

The Collapsible Breacher features a tempered stainless steel wedge with counter-angled friction ridges that are specifically designed to grip breaching surfaces securely. These ridges increase stability and reduce tool slippage during breaching operations.

- Includes all Dynamic Entry® Collapsible Tool Series™ standard features (see top of page)
- Length: 16.75" (collapsed), 24.5" (extended)
- Weight: 7.4 lbs.

DE-CB | Black | \$399.99



Dynamic Entry® Collapsible Mini ThunderSledge™

Featuring a 6-lb. drop-forged head, the Collapsible Mini ThunderSledge is custom-designed to deliver exceptional striking force when extended.

- Includes all Dynamic Entry® Collapsible Tool Series™ standard features (see top of page)
- Length: 14.5" (collapsed), 22" (extended)
- Weight: 10.2 lbs.

DE-CMTS | Black | \$349.99



Dynamic Entry® Collapsible Stainless Hallagan Tool

The Collapsible Stainless Hallagan Tool has the added benefit of a horn for stubborn prying chores and also features counter-angled friction ridges for tool stability and slippage prevention.

- Includes all Dynamic Entry® Collapsible Tool Series™ standard features (see top of page)
- Length: 16.75" (collapsed), 24.5" (extended)
- Weight: 7.7 lbs.

DE-CSHT | Black | \$399.99

Dynamic Entry® Small Pry™

A collaborative effort between BLACKHAWK!®'s Dynamic Entry and Knife design teams, the Small Pry is a revolutionary breaching tool that combines specialized prying capabilities with a readily available cutting edge. It's ideal for prying interior doors and drawers, window "break and rake" operations and tactical cutting chores like removing screens or chopping through drywall.

- Includes S.T.R.I.K.E.® mounting kit (15DE00BK-STRIKE) for attaching to PALS/MOLLE webbing or backpack mounting kit (15DE00BK-PACK) for attaching to Dynamic Entry® backpack kits
- Blade length: 4.390"/112 mm
- Overall length: 14.460"/367 mm
- Blade material: D-2 tool steel
- Blade finish: Corrosion-resistant black epoxy powder coating
- Edge type: Plain edge only
- Handle material: Checkered, over-molded thermoplastic rubber
- Sheath: Injection-molded nylon (15DE00YL comes with additional nylon web sheath, see below)
- Natural-gas-valve cutoff slot: 1.5"L x .6"W (15DE00YL only)
- Weight: 1.5 lbs. with sheath

Small Pry™ with S.T.R.I.K.E.® Mounting Kit | 15DE00BK-STRIKE | Black | \$199.99
 Small Pry™ With Backpack Mounting Kit | 15DE00BK-PACK | Black | \$199.99
 Emergency Rescue Small Pry™ | 15DE00YL | Yellow | \$199.99



for more: **You Tube**
[youtube.com/bpggear](https://www.youtube.com/bpggear)



Dynamic Entry® Small Pry Sheath

- Nylon web replacement sheath
- Adjustable to fit belts up to 4" wide

5100946BK | Black | \$39.99



Backpack Mounting Kit



S.T.R.I.K.E.® Mounting Kit



Dynamic Entry® Active Shooter Hallagan Tool

Designed with active-shooter callouts in mind, the Active Shooter Hallagan Tool's wedge features counter-angled friction ridges to help prevent tool slippage, grip breaching surfaces securely and increase bite when breaching even the most robust doors like those found in government and school facilities.

- Electrically nonconductive handle system is resistant to 100,000 volts AC
- Redesigned tempered stainless steel wedge and horn
- Ergonomic handle reinforces proper hand placement
- Non-sparking fork end
- Length: 24"
- Weight: 7.5 lbs.

DE-ASHT | Black | \$249.99



Dynamic Entry® Mini Break-N-Rake™

Designed in conjunction with domestic and international operators, the Mini Break-N-Break is a compact, lightweight and portable breaching tool—perfect for close-quarter window entries where space is at a minimum.

- Electrically nonconductive D-handle system is resistant to 100,000 volts AC
- Can replace Special Operations Hallagan Tool in the Tactical Backpack Kit (sold separately, see page 105)
- Easily fits in trunk of patrol or rescue vehicles
- Length: 25"
- Weight: 4.5 lbs.

DE-MBR | Black | \$159.99

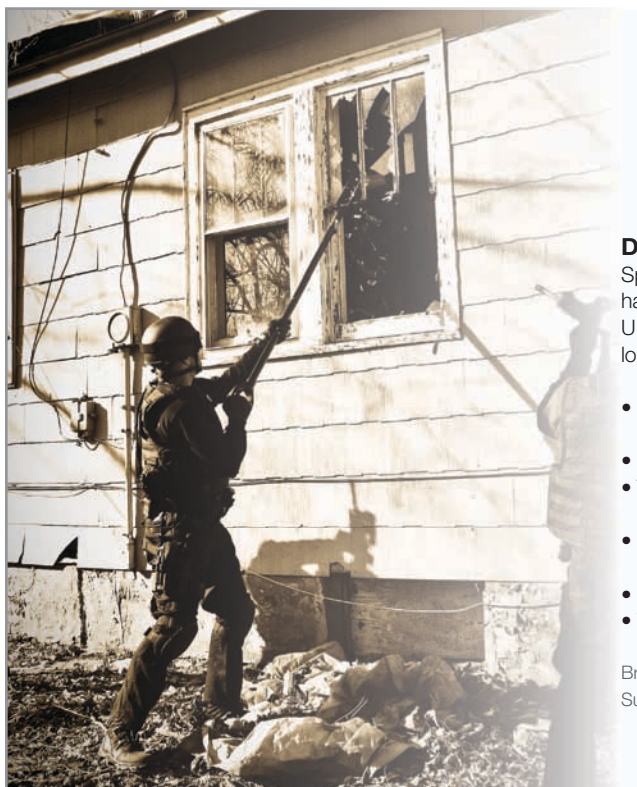

Dynamic Entry® Break-N-Rake™

Specifically engineered for window entries, the Break-N-Rake has been involved in successful tactical operations in both the U.S. and abroad. It is also ideal for securing secondary breach locations and creating tactical distractions.

- Electrically nonconductive D-handle system is resistant to 100,000 volts AC
- Military-grade steel serrated blade and laser-cut hook
- Three carbon steel 12" raking fins to clear away glass and other debris
- Reinforced hook removes curtains, blinds and other obstructions
- Length: 51" (DE-BR), 69" (DE-SBR)
- Weight: 9.6 lbs. (DE-BR), 11 lbs. (DE-SBR)

Break-N-Rake™ | DE-BR | Black | \$269.99

Super Break-N-Rake™ | DE-SBR | Black | \$269.99



Dynamic Entry® Mobile Home Door Breacher

Outward-opening mobile home doors have been a breacher's nightmare for years. But with the Mobile Home Door Breacher, you can safely and rapidly enter into outward-opening, metal-skin mobile home doors during tactical operations. It meets our legendary standards of excellence and is guaranteed to withstand years of use.

- Electrically nonconductive D-handle system is resistant to 100,000 volts AC
- Unique leverage orientation pulls locking mechanism free of doorjamb while opening door
- Reinforced, laser-cut carbon steel head
- Length: 28.5"
- Weight: 5.5 lbs.

DE-MHB | Black | \$207.99



Dynamic Entry® Tactical Breaching Saw

The 64" Tactical Breaching Saw keeps the operator at a safe distance while cutting inspection holes in false ceilings, breaching lightweight metal skins (such as those found on mobile homes) or cutting through sheetrock and other light building materials.

- Electrically nonconductive D-handle system is resistant to 100,000 volts AC
- High-carbon steel head with specifically positioned cutting teeth
- Sharpened edge and tip for chopping and cutting operations
- Sturdy sheath protects operator and tool
- Length: 64"
- Weight: 9.5 lbs.

DE-TBS | Black | \$249.99

DE-TBSY | Yellow | \$249.99

Dynamic Entry® Breaching Sledge

Our newly redesigned Breaching Sledge features a more compact breaching head for improved maneuverability and counter-angled friction ridges for added stability during breaching. The Breaching Sledge brings together the best of both worlds, combining the strike face of a sledge hammer with the prying wedge of a Hallagan Tool, all in a smaller and more balanced package.

- Micro-metal composition for added strength and reduced spalling when struck by another Breaching Sledge
- Electrically nonconductive fiberglass handle is resistant to 100,000 volts AC
- Sure-grip handle system reduces the chance of slippage during operations
- Friction ridges on the wedge for added grip and stability during breaching
- Available in Black and high-visibility Yellow
- Length: 22"
- Weight: 8 lbs.

DE-BS | Black | NSN# 5120-01-554-2827 | \$135.99

DE-BSY | Yellow | NSN# 5120-01-554-2827 | \$135.99

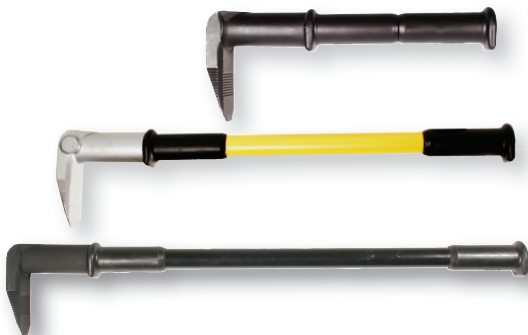

for more: **You Tube**
youtube.com/bpggear



Ideal for chopping and cutting



Dynamic Entry® Breacher Series

Designed for close-quarter breaching situations, these heavy-duty hallagan-style breaching tools are more robust than our standard non-sparking hallagans (see page 100).

- Electrically nonconductive handle system is resistant to 100,000 volts AC
- Tempered stainless steel wedge with counter-angled friction ridges for tool stability and slippage prevention
- Safety-guard handgrip reduces the possibility of operator's hands slipping onto working end of tool
- Length: 14.25" (DE-MB, DE-MBY), 24" (DE-SOB, DE-SOBY), 30" (DE-TB, DE-TBY)
- Weight: 4.7 lbs. (DE-MB, DE-MBY), 5.4 lbs. (DE-SOB, DE-SOBY), 6 lbs. (DE-TB, DE-TBY)

Mini Breacher | DE-MB | Black | \$181.99

Mini Breacher | DE-MBY | Silver | \$181.99

Special Operations Breacher | DE-SOB | Black | \$181.99

Special Operations Breacher | DE-SOBY | Yellow | \$181.99

Breacher | DE-TB | Black | \$181.99

Breacher | DE-TBY | Yellow | \$181.99

for more: **You Tube**
youtube.com/bpggear



Dynamic Entry® ThunderSledge Series™

The ThunderSledge tools exceed Dynamic Entry's high durability standards and are an essential supplement to any breaching kit.

- Electrically nonconductive handle system is resistant to 100,000 volts AC
- Sure-grip handle system reduces slippage during operations
- Drop-forged, heat-treated carbon steel striking head
- Length: 14" (DE-MCR), 22" (DE-MTS, DE-MTSY), 32" (DE-TS)
- Weight: 4.6 lbs. (DE-MCR), 7.5 lbs. (DE-MTS, DE-MTSY), 12 lbs. (DE-TS)

Micro ThunderSledge™ | DE-MCR | Black | \$69.99
 Mini ThunderSledge™ | DE-MTS | Black | NSN# 5120-01-554-2847 | \$75.99
 Mini ThunderSledge™ | DE-MTSY | Yellow | \$75.99
 ThunderSledge™ | Black | DE-TS | NSN# 5120-01-554-2857 | \$83.99

for more: **You Tube**
youtube.com/bpggear



Dynamic Entry® ThunderMaul™

The ergonomically designed ThunderMaul incorporates an axe and sledge into one compact tool for diverse entry functions.

- Electrically nonconductive handle system is resistant to 100,000 volts AC
- Sure-grip handle system reduces slippage during operations
- Drop-forged, heat-treated carbon steel striking head
- Nick-resistant tempered blade
- Length: 21.5"
- Weight: 7.5 lbs.

DE-TM | Black | NSN# 4210-01-532-4603 | \$84.99
 DE-TMY | Yellow | \$75.99

Dynamic Entry® Dynamic Duo™ Kit

The durable, easily deployable Dynamic Duo can be used in the majority of breaching situations. A more compact version, the Mini Dynamic Duo is also available for close-quarter operations.

- Includes Dynamic Entry® Breacher (DE-TB, see page 98)
- Includes Dynamic Entry® ThunderSledge™ (DE-TS, see page 95)
- Includes Dynamic Entry® Dynamic Duo Quiver (DE-DDQ, see below)
- Length: 32" (DE-DD), 23" (DE-MDD)
- Weight: 18 lbs. (DE-DD), 13 lbs. (DE-MDD)

Dynamic Duo™ Kit | DE-DD | Black | \$265.99
 Mini Dynamic Duo™ | DE-MDD | Black | \$265.99

Buy the Dynamic Entry® Dynamic Duo™ Kit and save over \$30 (compared to buying each item separately)!



Dynamic Entry® Dynamic Duo Quiver

- Quick-release straps for immediate "dumping" and rapid deployment

DE-DDQ | Black | \$31.99

Dynamic Entry® U.K. Hallagan Tool

Featuring a unique glass-buster head for “break and rake” operations, the U.K. Hallagan Tool utilizes a redesigned, tempered stainless steel wedge with friction ridges on all contact surfaces.

- Electrically nonconductive handle system is resistant to 100,000 volts AC
- Safety-guard handgrip reduces the possibility of operator’s hands slipping onto working end of tool
- Tempered stainless steel wedge with counter-angled friction ridges for tool stability and slippage prevention
- Wedge: 2” x 4”
- Length: 32.5”
- Weight: 7.5 lbs.

DE-UKHT | Black | NSN# 4210-01-517-7056 | \$239.99

for more:  [youtube.com/bpggear](https://www.youtube.com/bpggear)



Dynamic Entry® Non-Sparking, Electrically Nonconductive Hallagan Tool Series

Designed for potentially volatile environments, this tool line features a composite construction that won’t spark during prying operations or when struck.

- Non-sparking, electrically nonconductive handle system is resistant to 100,000 volts AC
- Ergonomic handle reinforces proper hand placement
- Fork and horn end for prying and breaching
- Use with Dynamic Entry® ThunderSledge™ tools (sold separately, see page 95) to effectively breach padlocks
- Length: 24” (DE-SOHT), 29.5” (DE-HT), 40” (DE-GB)
- Weight: 7.5 lbs. (DE-SOHT), 8 lbs. (DE-HT), 17.5 lbs. (DE-GB)

Special Operations Hallagan Tool | DE-SOHT | Black | NSN# 5120-01-507-1498 | \$191.99
Hallagan Tool | DE-HT | Black | \$191.99
Gorilla Bar | DE-GB | Black | \$233.99



Note: The non-sparking alloy used in our Dynamic Entry® Non-Sparking, Electrically Nonconductive Hallagan Tools is not intended for use on steel doors or frames. When breaching steel doors, we recommend using one of our stainless steel tools such as the Stainless Hallagan Tool (see below).

Dynamic Entry® Stainless Hallagan Tool Series

The hallagan tool has been a standard entry tool for law enforcement and fire/EMS professionals for nearly 75 years. Using recommendations from operators in the field, we’ve taken this classic design and modernized it for the 21st century.

- Electrically nonconductive handle system is resistant to 100,000 volts AC
- Safety-guard handgrip reduces the possibility of operator’s hands slipping onto working end of tool
- Tempered stainless steel wedge with counter-angled friction ridges for tool stability and slippage prevention
- Length: 24” (DE-SOSHT), 31” (DE-SHTB, DE-SHTY)
- Weight: 8 lbs. (DE-SOSHT), 8 lbs. (DE-SHTB, DE-SHTY)

Special Operations Stainless Hallagan Tool | DE-SOSHT | Black | \$285.99
Stainless Hallagan Tool | DE-SHTB | Black | NSN# 5120-01-554-3768 | \$285.99
Stainless Hallagan Tool | DE-SHTY | Yellow | \$285.99



Dynamic Entry® Classic Hallagan Tool

Known the world over for our unique hallagan tool designs, we're proud to introduce the Classic Hallagan Tool. This is a traditional design in the mold of original hallagan tools used early in the 20th century. Strong and lightweight, the Classic Hallagan Tool meets and exceeds the needs of today's fire/EMS professionals.

- One-piece, drop-forged alloy steel
- Made to exacting standards in the USA
- Forged-in sling attachments
- Includes sling with horn-protecting cover
- Horn: 4.25"
- Length: 30"
- Weight: 10 lbs.

DE-CHT30 | Black | \$229.99



Dynamic Entry® Special Operations Entry Ram

The Special Operations Entry Ram answers all the requests and suggestions from operators in the field for a compact yet powerful tactical entry ram. Its convenient ambidextrous design features one lead handle and two opposing side handles, allowing for multiple grip configurations to help meet mission-specific requirements.

- Non-sparking, electrically nonconductive handle system is resistant to 100,000 volts AC
- Ergonomic control-flex handle system reduces impact stress
- Ambidextrous handle orientation for one- or two-person operation
- Forward-weighted design is a close-quarter alternative to the MonoShock Ram™
- Length: 25"
- Weight: 30 lbs.

DE-SOER | Black | \$299.99

for more: **You Tube**
youtube.com/bpggear



Dynamic Entry® CQB Ram™

When door-breaching speed is required for lightweight exterior and most interior doors, the CQB is the ram of choice.

- Non-sparking, electrically nonconductive handle system is resistant to 100,000 volts AC
- Oversized control-flex handle system keeps breachers outside the "fatal funnel" even in cramped areas
- Length: 20"
- Weight: 23 lbs.

DE-CQB | Black | NSN# 4210-01-522-1018 | \$270.99

for more: **You Tube**
youtube.com/bpggear



Dynamic Entry® MonoShock Ram™

The flagship of the Dynamic Entry tool line, our MonoShock Ram is the expert breacher's entry ram of choice.

- Non-sparking, electrically nonconductive handle system is resistant to 100,000 volts AC
- Ergonomic control-flex handle system reduces impact stress
- Includes padded quick-release sling
- Length: 31.5"
- Weight: 32 lbs.

DE-MS | Black | NSN# 4210-01-517-7055 | \$343.99



Dynamic Entry® Twin Turbo™

This two-man entry ram features the identical manufacturing standards of our legendary MonoShock Ram™ but is designed for one- or two-person operation.

- Non-sparking, electrically nonconductive handle system is resistant to 100,000 volts AC
- Ergonomic control-flex handle system reduces impact stress
- Includes padded quick-release sling
- Length: 40"
- Weight: 41.5 lbs.

DE-TT | Black | NSN# 4210-01-517-7054 | \$436.99

Dynamic Entry® Thor's Hammer

Since its introduction to the tactical entry tool arena, the Thor's Hammer has earned a solid reputation as one of the most versatile tools among standard battering ram designs. After-action reports have shown it to be effective on lightweight exterior and most interior doors.

- Sure-grip handle system reduces slippage during operations
- Operator-friendly design allows it to be swung outside the "fatal funnel"
- Includes ergonomic pack with extended pouch design that wraps around operator's body for close fit
- Length: 24"
- Weight: 15.4 lbs.

DE-TH | Black | \$270.99



for more:  [youtube.com/bpggear](https://www.youtube.com/bpggear)

Dynamic Entry® BoltMaster™ Series

The heat-treated cutting edges of the BoltMaster series are the finest available anywhere. Lightweight and durable, each tool's head features a tension adjustment that allows precision tuning for maximum cutting effectiveness.



- Electrically nonconductive fiberglass handle system is resistant to 100,000 volts AC
- Safety-guard handgrip reduces the possibility of operator's hands slipping onto working end of tool
- For use on security chains, chain link fences and non-case-hardened locks
- Jaw opening: 3/8" (DE-MBM, DE-MBMY), 3/8" (DE-BM, DE-BMY), 7/16" (DE-SBM, DE-SBMY)
- Length: 18" (DE-MBM, DE-MBMY), 24" (DE-BM, DE-BMY), 30" (DE-SBM, DE-SBMY)
- Weight: 5.15 lbs. (DE-MBM, DE-MBMY), 5.75 lbs. (DE-BM, DE-BMY), 8 lbs. (DE-SBM, DE-SBMY)

Mini BoltMaster™ | DE-MBM | Black | \$199.99
 Mini BoltMaster™ | DE-MBMY | Yellow | \$199.99
 BoltMaster™ | DE-BM | Black | NSN# 5110-01-534-0120 | \$199.99
 BoltMaster™ | DE-BMY | Yellow | \$199.99
 Super BoltMaster™ | DE-SBM | Black | NSN# 5110-01-532-4999 | \$334.99
 Super BoltMaster™ | DE-SBMY | Yellow | \$334.99



Dynamic Entry® BoltMaster™ Sling

Designed to carry the BoltMaster hands-free and at the ready, the Dynamic Entry BoltMaster Sling is constructed of heavy-duty nylon with hook & loop attachment points and a padded shoulder strap.

DE-BMSL | Black | \$32.99



Dynamic Entry® Padlock Buster

Designed for situations where the BoltMaster™ is not recommended, the Padlock Buster is stunningly effective in defeating case-hardened padlocks. It's the perfect complement to any team's tactical toolbox.

- Electrically nonconductive handle system is resistant to 100,000 volts AC
- Classic duckbill design for use on various padlock sizes
- Constructed of military-grade AR400 steel
- Length: 24.25"
- Weight: 6.3 lbs.

DE-PB | Black | \$159.99



Dynamic Entry® Super Pulaski Tool

Designed for professionals by professionals, our Super Pulaski Tool is the long-awaited answer for the needs of the 21st century.

- Electrically nonconductive polypropylene, fiberglass handle system is resistant to 100,000 volts AC
- Solid-piece, drop-forged high-carbon steel construction
- Expanded grubbing end for increased digging and grubbing effectiveness
- Balanced for optimum effectiveness
- Cutting edges: 5" (hoe), 4.5" (axe)
- Length: 34.25"
- Weight: 7.5 lbs.

WF-SPT | Yellow | \$137.99



Dynamic Entry® DE 9-11 Series Rescue Axes

Developed with Dynamic Entry's legendary standard of excellence, the DE 9-11 Series Rescue Axes are available in both red and high-visibility yellow.

- Electrically nonconductive fiberglass handle system is resistant to 100,000 volts AC
- Drop-forged, heat-treated carbon steel heads
- Length: 37"
- Weight: 8 lbs. (DE-AY6P, DE-AR6P), 10 lbs. (DE-AY8P, DE-AR8P), 8 lbs. (DE-AY6F, DE-AR6F)

- 6-lb. Pike Axe | DE-AY6P | Yellow | \$103.99
- 6-lb. Pike Axe | DE-AR6P | Red | \$103.99
- 8-lb. Pike Axe | DE-AY8P | Yellow | \$129.99
- 8-lb. Pike Axe | DE-AR8P | Red | \$129.99
- 6-lb. Flat Axe | DE-AY6F | Yellow | \$96.99
- 6-lb. Flat Axe | DE-AR6F | Red | \$96.99



Dynamic Entry® Single Bit Axe

Designed as a fast-working tool in cramped environments, this precision-balanced axe features a 19.5" high-visibility yellow fiberglass handle and 2-lb. head with a 4" cutting edge.

- Length: 22.5"
- Weight: 4.5 lbs.

WF-SBA | Yellow | \$64.99

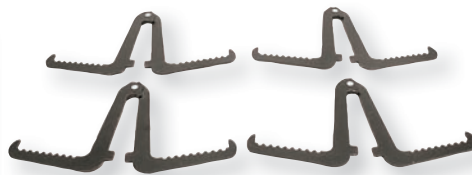

Dynamic Entry® Tactical Fence Climbers

Through rigorous research and development, the Dynamic Entry design team has created a laser-cut fence climber that is lighter, more compact and easier to deploy than the original. Our Tactical Fence Climbers provide a scaling rung on both sides of the fence for easy and rapid egress.

- Lightweight construction
- Folds up for easy storage
- Set of four
- Weight: 5.2 lbs.

DE-TFC | Black | \$158.99

Tactical Backpack Series

Since its introduction, the Dynamic Entry® Tactical Backpack Series has been the standard for law enforcement and military agencies worldwide. From the original Tactical Backpack Kit to our Modular Backpack™, we provide mission-specific tooling options to best meet operators' tactical entry needs.



Dynamic Entry® Tactical Backpack Kit

The standard for most breaching operations, the Tactical Backpack Kit includes three specialized entry tools and the Manual Entry Tool Pack.

- Includes Dynamic Entry® BoltMaster™ (DE-BM, see page 103)
- Includes Dynamic Entry® ThunderMaul™ (DE-TM, see page 99)
- Includes Dynamic Entry® Special Operations Hallagan Tool (DE-SOHT, see page 100)
- Includes Dynamic Entry® Manual Entry Tool Pack (60ME00BK, see page 106)

DE-TBK | Black | \$582.99



Dynamic Entry® Tactical Backpack Kit-B

Quickly becoming the new standard, the Tactical Backpack Kit-B comes complete with three powerful tools and the rugged Manual Entry Tool Pack.

- Includes Dynamic Entry® BoltMaster™ (DE-BM, see page 103)
- Includes Dynamic Entry® ThunderMaul™ (DE-TM, see page 99)
- Includes Dynamic Entry® Special Operations Breacher (DE-SOB, see page 98)
- Includes Dynamic Entry® Manual Entry Tool Pack (60ME00BK, see page 106)

DE-TBK-B | Black | \$572.99

Dynamic Entry® Tactical Backpack Kit-C

Designed to meet active-shooter callouts, the Tactical Backpack Kit-C carries three barrier-smashing entry tools inside the Manual Entry Tool Pack.

- Includes Dynamic Entry® BoltMaster™ (DE-BM, see page 103)
- Includes Dynamic Entry® ThunderMaul™ (DE-TM, see page 99)
- Includes Dynamic Entry® Active Shooter Hallagan Tool (DE-ASHT, see page 96)
- Includes Dynamic Entry® Manual Entry Tool Pack (60ME00BK, see 106)

DE-TBK-C | Black | \$599.99





Dynamic Entry® Manual Entry Tool Pack

The Manual Entry Tool Pack is designed to carry the Special Operations Hallagan Tool or Special Operations Breacher, the ThunderMaul™ or Mini ThunderSledge™ and the BoltMaster™.

- Entry tools not included (pack only)
- Constructed of durable 1000 denier nylon
- Heavily padded with closed-cell foam
- Retention straps hold tools securely
- Fully adjustable chest and waist straps
- Individual pouches
- Weight: 2 lbs.

60ME00BK | Black | NSN# 8465-01-533-5371 | \$116.99

Dynamic Entry® U.K. M.O.E.™ Backpack Kit

Designed for Special Forces units worldwide, our U.K. M.O.E. Backpack Kit is the tactical entry kit of choice for most reinforced breaching operations.

- Includes Dynamic Entry® Super BoltMaster™ (DE-SBM, see page 103)
- Includes Dynamic Entry® CQB Ram™ (DE-CQB, see page 101)
- Includes Dynamic Entry® U.K. Hallagan Tool (DE-UKHT, see page 100)
- Includes Dynamic Entry® U.K. M.O.E.™ Tool Pack (990662BK, see page 106)

DE-UKMOEK | Black | NSN# 8465-01-563-3974 | \$931.99



Dynamic Entry® U.K. M.O.E.™ Tool Pack

The U.K. M.O.E. Tool Pack was designed for elite Special Forces to provide tool security during extreme maneuvers such as running, climbing or rappelling.

- Entry tools not included (pack only)
- Fully adjustable shoulder, waist and under-the-leg straps keep pack anchored to operator's body
- Two large retention flaps
- Weight: 2 lbs.

990662BK | Black | \$145.99

Dynamic Entry® Modular Backpack

The Modular Backpack integrates S.T.R.I.K.E.® webbing, our proven Speed Clip™ devices and Dynamic Entry's Modular Attachment System to provide a fully customizable entry tool platform.

- Entry tools not included (pack only)
- Constructed of durable 1000 denier nylon
- Lumbar padding and wide shoulder straps for maximum comfort
- Large tear-resistant, Kydex®-lined tool pouch with reinforced drain holes
- Modular retention straps for quick and secure mission-specific tool configurations
- Includes assortment of various sized modular retention straps
- Weight: 2 lbs.

DE-MBP | \$199.99

for more:  youtube.com/bpggear



Stores easily in the trunk of a patrol car and is ideal for active-shooter callouts



Did you know? Our Speed Clips™ were designed to give you an alternative to tedious weaving of bulky straps used for modular S.T.R.I.K.E.® or PALS/MOLLE webbing attachment. Quickly mount gear and rearrange your kit without hesitation! To learn more, see page 214.

Dynamic Entry® Mini Deployment Kit

As active-shooter callouts have become more complex in nature, our research team developed the Mini Deployment Bag to meet these ever-changing requirements. This kit can easily be stored in the trunk of patrol or rescue vehicles.

- Includes Dynamic Entry® Mini Breacher (DE-MB, see page 98)
- Includes Dynamic Entry® Micro ThunderSledge™ (DE-MCR, see page 99)
- Includes Dynamic Entry® Mini BoltMaster™ (DE-MBM, see page 103)
- Includes Dynamic Entry® Mini Deployment Bag (60ME03BK, see page 108)

DE-MDK | Black | \$499.99



Dynamic Entry® Mini Deployment Bag

Designed to carry the Mini BoltMaster™, Mini Breacher and Micro ThunderSledge™ at the ready, the Mini Deployment Bag can easily be stored in the trunk of patrol or rescue vehicles.

- Entry tools not included (bag only)
- Heavy-duty drag handle
- Shoulder strap with quick-release buckles for ambidextrous carry
- Thigh straps for added stability during extreme body movements
- Internal compartments keep tools secure and reduce noise signature
- Two multipurpose side pockets
- Weight: 2 lbs.

60ME03BK | Black | \$79.99



Save over \$30 when you buy the Dynamic Entry® Mini Deployment Kit or Mini Tool Kit (compared to buying each item separately)!

Dynamic Entry® Mini Tool Kit

To fulfill requests for a lighter, tougher tactical entry kit, the Dynamic Entry design team created the Mini Tool Kit, featuring an assortment of potent entry tools.

- Includes Speed Clips™ (see page 214)
- Includes Dynamic Entry® Mini Breacher (DE-MB, see page 98)
- Includes Dynamic Entry® Micro ThunderSledge™ (DE-MCR, see page 99)
- Includes Dynamic Entry® Mini BoltMaster™ (DE-MBM, see page 103)
- Includes two Dynamic Entry® Single Tool Carriers (5100856BK, see below)
- Includes Dynamic Entry® Mini BoltMaster™ Pouch (5100880BK, see below)



DE-MTK | Black | \$499.99



Dynamic Entry® Single Tool Carrier

5100856BK | Black | \$39.99



Dynamic Entry® Mini BoltMaster™ Pouch

5100880BK | Black | \$54.99

Tactical Entry Kits

These Tactical Entry Kits offer convenient options and are designed to meet all your tactical entry tooling needs. Buy any kit and save 10% compared to buying each item separately!



Dynamic Entry® Entry Kit #1

The Tactical Entry Kit #1 is the perfect kit for standard tactical entries, featuring the MonoShock Ram™ and Dynamic Duo™.

- Includes Dynamic Entry® MonoShock Ram™ (DE-MS, see page 102)
- Includes Dynamic Entry® Dynamic Duo™ (DE-DD, see page 99)
- Kit value: \$609.97

DE-EK1 | Black | \$557.99

Dynamic Entry® Entry Kit #2

The Tactical Entry Kit #2 combines the MonoShock Ram™ and Break-N-Rake™ with the Tactical Backpack Kit-B to for more challenging entries.

- Includes Dynamic Entry® MonoShock Ram™ (DE-MS, see page 102)
- Includes Dynamic Entry® Break-N-Rake™ (DE-BR, see page 97)
- Includes Dynamic Entry® Tactical Backpack Kit-B (DE-TBK-B, see page 105)
- Kit value: \$1,167.97

DE-EK2 | Black | \$1,060.99



Dynamic Entry® Entry Kit #3

Bringing together the best Dynamic Entry has to offer, the Tactical Entry Kit #3 features the MonoShock Ram™, Tactical Backpack Kit-B and Break-N-Rake™ for less-than-conventional tactical entries. The kit also includes the revolutionary Mobile Home Door Breacher and Dynamic Duo™. With this kit, Nothing Shall Stand in Your Way®.

- Includes Dynamic Entry® MonoShock Ram™ (DE-MS, see page 102)
- Includes Dynamic Entry® Dynamic Duo™ (DE-DD, see page 99)
- Includes Dynamic Entry® Break-N-Rake™ (DE-BR, see page 97)
- Includes Dynamic Entry® Mobile Home Door Breacher (DE-MHB, see page 97)
- Includes Dynamic Entry® Tactical Backpack Kit-B (DE-TBK-B, see page 105)
- Kit value: \$1,641.95

DE-EK3 | Black | \$1,486.99

Knoxx® Shotgun Breacher's Stock and Accessory Kit

A collaborative effort between our Dynamic Entry® and Knoxx design teams, this kit features a Knoxx BreachersGrip™ (see page 243), weapon's catch, sling and body armor adapter. The catch, sling and adapter work together to provide an effective and secure retention system. The weapon's catch attaches to either a vest with S.T.R.I.K.E.® webbing using our proven Speed Clips™ or to a standard issue duty belt using ALICE clip retention straps. The sling attaches to the butt of the stock while the adapter loops around the shoulder section of the breacher's body armor.

K02199-B | Black | Remington® 870 12 Gauge (All Models) | \$134.99

K02299-B | Black | Mossberg® 12 Gauge (Models 500, 590, 835, 88) | \$134.99

K02099-B | Breacher's Kit (No Stock) | \$59.99

for more: **You Tube**
youtube.com/bpggear



Weapon's Catch



(2) Speed Clips™



(2) ALICE Clips



Vest Attachment with D-Ring



Single-Point Swivel Sling



Knoxx® BreachersGrip™



Night-Ops® Legacy™ Tactical Handheld Light **NEW!**

Featuring an aluminum body with hard-coat anodized finish, this tactical light gives you big light output in a rugged design. The rotating function selector switch allows you to activate the light with your preferred setting. No need to scroll through functions with a momentary switch!

- Tested to meet ANSI FL1 standards
- Multifaceted reflector
- Tempered glass lens
- Multiple-position rotating switch (High, Med, Low, Strobe, Safety Off)
- Momentary/Constant On recessed push button
- Settings for 200/100/15 lumens and strobe at max (L-2A2)
- Settings for 570/220/20 lumens and strobe at max (L-6V)
- Compatible with Offset Flashlight Rail Mount (sold separately, see page 188)
- Max output: 200 lumens (L-2A2) or 570 lumens (L-6V)
- Diameter: 1" body and 1.26" bezel (both)
- Length: 7.3" (L-2A2), 6.1" (L-6V)
- Weight (with/without batteries): 6.80 oz./5.65 oz. (L-2A2), 8.70 oz./6.95 oz. (L-6V)
- Runtime on High Setting: 90 minutes (L-2A2), 120 minutes (L-6V)
- Battery: Two AA (L-2A2) or two 3-volt CR123 (L-6V)
- Bulb: High-output CREE® XP-G LEDs (L-2A2) or XM-L LEDs (L-6V)

L-2A2 (2xAA) | 75FL026 | BK | \$99.99

L-6V (2xCR123) | 75FL027 | BK | \$119.99



L-6V



L-2A2

Night-Ops® Ally™ Compact Handheld Light **NEW!**

This robust tactical light boasts a compact profile and smaller diameter with a pocket clip for everyday carry. Its aluminum body with hard-coat anodized finish will give you long-lasting performance for any task. The rotating function selector switch allows you to activate the light with your preferred setting. No need to scroll through functions with a momentary switch!

- Multifaceted reflector
- Multiple-position rotating switch (High, Med, Low, Strobe, Safety Off)
- Momentary/Constant On recessed push button
- Settings for 100/40/5 lumens and strobe at max (L-1A2)
- Settings for 150/65/15 lumens and strobe at max (L-2A2)
- Settings for 150/65/15 lumens and strobe at max (L-3V)
- Max output: 100 lumens (L-1A2), 150 lumens (L-2A2, L-3V)
- Diameter: 0.875" body and 1.135" bezel (all)
- Length: 4.5" (L-1A2), 6.3" (L-2A2), 4" (L-3V)
- Weight (with/without batteries): 4.1 oz./3.2 oz. (L-1A2), 6.10 oz./4.35 oz. (L-2A2), 3.5 oz./2.9 oz. (L-3V)
- Runtime: 90 minutes (L-1A2, L-2A2), 135 minutes (L-3V)
- Battery: One AA (L-1A2), two AA (L-2A2) or two 3-volt CR123 (L-3V)
- Bulb: High-output CREE® XP-E LEDs

L-1A2 | 75FL023 | BK | \$59.99

L-2A2 | 75FL024 | BK | \$69.99

L-3V | 75FL025 | BK | \$69.99



L-3V



L-1A2



L-2A2



Night-Ops® Xiphos™ NTX Weapon Mounted Light

Designed for one-hand activation, this featherweight weapon-mounted light features a patent-pending Cam-Clamp mount that lets you quickly install the light onto nearly any rail weapon mount without the use of tools. The Cam-Clamp eliminates the need to slide the light down long rails, and it installs in the desired location instantly.

- Injection-molded carbon-fiber/polymer body
- Stainless steel and black oxide-finish metal
- Corrosion-resistant black anodized aluminum
- Ambidextrous operation of all programmed functions
- Intelligent circuit design eliminates afterglow
- No tools required for installation or battery removal
- Anti-reflective glass lens for maximum light output
- High-impact lifetime LED resists high G-forces from recoil and drops
- Improved tail cap and switch
- Modes of output: Momentary Switch, Constant On, Strobe, and Low Battery Indicator
- Max output: 180 lumens
- Diameter: 1.1"
- Length: 3.1"
- Weight (with/without batteries): 2.5 oz./1.9 oz.
- Runtime: 120 minutes
- Battery: One 3-volt CR123A
- Bulb: High-impact CREE® X LED

Right Hand | 75206BK | Black | \$199.99
 Left Hand | 75206BK-L | Black | \$199.99



Night-Ops® Ally™ PL3X XTR **WHILE SUPPLIES LAST**

Heading out on a hunt? Gear up with this high-output tactical light, featuring the latest generation CREE® XR-E bulb for the smoothest beam of light possible.

- Modes of output: Momentary Switch and
- Mode of output: Constant On
- Max output: 85 lumens
- Diameter: 1.125"
- Length: 5.25"
- Weight (with/without batteries): 4.7 oz./3.5 oz.
- Runtime: 120 minutes
- Battery: Two 3-volt CR123A
- Bulb: High-impact CREE® XR-E LED

75FL022 | BK | \$174.99



The Night-Ops® Xiphos™ NTX Weapon Mounted Light is designed to fit inside any of our SERPA® Light Bearing Holsters. Choose from concealment, duty or tactical models. See page 122, 124 and 127.



Night-Ops® Legacy™ X-6, X6-P and X9-P
WHILE SUPPLIES LAST

The Legacy family of lights offers big light output in a compact, rugged package. Perfect for duty carry, personal defense or outdoor excursions, the Legacy X6, Legacy X6-P and Legacy X9-P are the latest generation of powerful Xenon lamp systems. The penetrating beam signature is perfectly pre-focused, leaving no shadows or artifacts.

- Aluminum (X6) or polymer (X6-P, X9-P) body
- Anti-roll system for stability
- Completely pre-focused, penetrating light beam leaves no shadows or artifacts
- Modes of output: Momentary Switch, Constant On
- Max output: 65 lumens (X6), 65 lumens (X6-P), 120 lumens (X9-P)
- Diameter: 1.34" (X6), 1.25" (X6-P), 1.25" (X9-P)
- Length: 5.12" (X6), 5" (X6-P), 6.25" (X9-P)
- Weight (with/without batteries): 4.23 oz./3.0 oz. (X6), 4.3 oz./3.1 oz. (X6-P), 5.2 oz./3.5 oz. (X9-P)
- Runtime: 120 minutes
- Battery: Two 3-volt CR123A (X6), two 3-volt CR123A (X6-P), Three 3-volt CR123A (X9-P)
- Bulb: Xenon



Legacy™ X6
Aluminum

Legacy™ X6-P
Polymer

Legacy™ X9-P
Polymer

L6I 75FL001 | BK | \$89.99

L6-P | 75FL004 | BK, CT, FG, YL | \$49.99

L9-P | 75FL005 | BK, YL | \$59.99

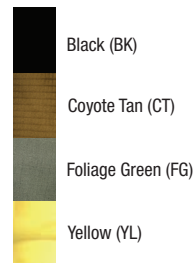

Night-Ops® Legacy™ XHR7 WHILE SUPPLIES LAST

Delivering a high-output, pre-focused beam of light, this heavy-duty design gets the job done. It uses the latest generation Samsung® lithium ion rechargeable battery, leaving no "memory effect" and allowing you to recharge the light anytime during the battery's lifecycle.

- Includes adapter
- AC/DC charger input hidden under rotating protective collar below bezel head
- Max output: 350 lumens
- Diameter: 2.25"
- Length: 7.88"
- Weight (with/without batteries): 10 oz./8.8 oz.
- Runtime: 60 minutes
- Battery: One 7.2-volt lithium ion
- Bulb: Xenon with halogen

75FL008 | BK | \$299.99



AC/DC charger (included)



Car charger (included)



XB-9, 9-Volt Xenon Replacement Bulb
WHILE SUPPLIES LAST

75AL005 | \$42.99



Replacement Bulb for Falcata™
9V WHILE SUPPLIES LAST

75RB0100 | \$34.99



XB-12, 12-Volt Xenon Replacement Bulb
WHILE SUPPLIES LAST

- For Night-Ops® Legacy™ X12 lights

75AL006 | \$48.99



Legacy™ Series Filters
WHILE SUPPLIES LAST

- Designed to fit Night-Ops® Legacy™ X9 or X12 lights
- Available in Blue (BL), Green (GR) or Infrared (IR) filters

75AF002 | BL, GR, IR | \$19.99 (IR = \$59.99)

Quick Tip: Use the Offset Flashlight Rail Mount (see page 188) to mount your flashlight with 1" diameter body to any Picatinny spec rails.



Night-Ops® Flashlight Holder with Mod-U-Lok™ Platform

- Securely carry popular issued personal tactical lights (with 1.25" diameter bezel and 1" diameter body)
- Accommodates bezel-up or bezel-down carry
- Quick-disconnect belt loop with one-handed release
- Attach to belt without unthreading other gear
- Positive engagement keeps belt loop in place
- Fits belts up to 2.25" wide (includes spacer for use with narrower belts)
- Adjustable cant for mounting light at various angles

75GH00 | BK | \$23.99

Pressure Remote Tape Switches
WHILE SUPPLIES LAST

- Replacement tail-cap assembly with remote tape switch to convert BLACKHAWK!® handheld lights into weapon-mounted lights (1" flashlight mount required)
- 2.375" pressure pad attaches to weapon with set of adhesive hook & loop patches (included)
- 11" cord for convenient switch placement without interfering with weapon operation
- Cord attaches to tail cap with mini plug connector to reduce cord fatigue and allow quick light removal
- Compatible with the Night-Ops® Legacy™ X6, Legacy XR7, Legacy L6R, Ally™ PLR and Conquest PL3

75AS001 | \$59.99



Mod-U-Lok™ Platform



Belt Mounted

Technology

Whether you're on duty, gearing up for combat or heading out on the shooting range, our footwear gives you the comfort, stability, pronation control and support to help you go that extra mile. We use the highest quality materials to ensure long-lasting performance in virtually any climate or condition.

OrthoLite® Footbed

All of our boots are equipped with a washable, antimicrobial, custom-molded OrthoLite® footbed, giving you quick-drying, breathable cushion. This insole technology is highly abrasion resistant and won't break down or lose effectiveness over time.



Vibram® Outsoles

The Vibram brand is widely recognized as a leader in high-performance soling products. In an effort to maintain our meticulous quality standards, we incorporate Vibram outsoles in many of our boots to help you survive practically any terrain.



Dri-Lex® Lining

Dri-Lex is a multi-layer lining system that expertly transports moisture away from the foot to help keep you dry and cool. Our Desert Ops™ and Black Ops™ Boots incorporate this technology for added comfort during tactical operations.



Injection-Molded Lace Lock

Several of our tactical boots incorporate an injection-molded lace lock—a quick no-tie lacing system that's designed to keep your laces locked down. The lace ends stow away neatly in a pocket on the tongue so you don't have to worry about the laces catching on objects or becoming a tangled mess.



Stealth Gray (GY)

Tanto Light Hiker

The cross-functional Tanto Light Hiker easily transitions between the range and hiking trail, providing outstanding traction and comfort.

- Nubuck suede and lightweight, breathable nylon mesh upper
- Waterproof injection-molded insole board
- Self-cleaning, multi-directional lugs
- Semi-rigid heel and toe cap reinforcement
- Quick-access, slip on bungee lacing system with cordlock keeps laces in place
- Washable, antimicrobial, custom-molded OrthoLite® footbed
- Available in Medium (M) and Wide (W) sizes

83BT06 | DE, GY | Men's 4.5 – 6.5M, 7 – 14M or W | \$99.99

Desert Tan (DE)



Tall Tanto Boots

The Tall Tanto Boots—a taller version of our Tanto Light Hiker—are ideal for waterborne or hot-weather operations and are built to keep your feet comfortable and supported no matter where your adventures take you.

- Ventilated, quick-drying properties
- Lightweight, breathable nylon mesh upper with padded collar
- Waterproof injection-molded insole board
- Self-cleaning, multi-directional lugs
- Semi-rigid heel and toe cap reinforcement
- Washable, antimicrobial, custom-molded OrthoLite® footbed
- Vibram® “Globetrotter” shock-absorbing rubber outsole
- Injection-molded lace lock system keeps laces secure and stowed away
- Available in Medium (M) and Wide (W) sizes

83BT07 | BK, DE | Men's 4.5 – 6.5M, 7 – 14M or W | \$149.99



Black (BK)



Desert Tan (DE)

Light Assault™ Boots

Designed for waterborne or hot-weather ops, this rugged yet agile tactical boot will help keep you light on your feet even when you're trekking through the most demanding terrain.

- Ventilated, quick-drying properties
- Lightweight, breathable nylon mesh and abrasion-resistant, quick-drying synthetic microfiber upper
- Waterproof injection-molded insole board
- Moisture-wicking Dri-Lex® inner lining
- Nylon shank for additional support when under load of full pack
- Abrasion-resistant, non-woven “back counter” reinforcement inside heel
- Washable, antimicrobial, custom-molded OrthoLite® footbed
- Vibram® “Trail Run” oil-resistant rubber outsole
- Injection-molded lace lock system keeps laces secure
- Available in Medium (M) and Wide (W) sizes

83BT00 | BK, CT | Men's 4.5 – 6.5M, 7 – 15M or W | \$174.99



Black (BK)



Coyote Tan (CT)





Desert Ops™ Boots

These hardwearing tactical boots take you from point A to point B while keeping your feet cool, dry and comfortable. Combining lightweight, breathable, water-resistant CORDURA® panels and an abrasion-resistant suede upper, the Desert Ops Boots are built to perform.

- Fully gusseted tongue prevents debris from entering boot
- Moisture-wicking Dri-Lex® inner lining
- Nylon shank for additional support when under load of full pack
- Abrasion-resistant, non-woven “back counter” reinforcement inside heel
- Toe reinforcements and extra layer of suede in heel for abrasion resistance
- Washable, antimicrobial, custom-molded OrthoLite® footbed
- Vibram® “Multisport” oil-resistant TC4+ compound outsole with large, open lugs for traction and traversing debris
- Available in Medium (M) and Wide (W) sizes

83BT02 | CT, DE, SG | Men's 4.5 – 6.5M, 7 – 14M or W | \$159.99

If you're looking for a pair of tactical boots that comply with U.S. Army regulations, then choose our Desert Ops™ Boots in Desert Tan (DE).



Coyote Tan (CT)



Desert Tan (DE)



Sage Green (SG)

Black Ops™ Boots

Get unrivaled support and comfort with the Black Ops Boots. Built with lightweight, breathable, water-resistant CORDURA® and abrasion-resistant suede upper, these tactical boots are designed to withstand rigorous use in tough environments.

- Fully gusseted tongue prevents debris from entering boot
- Moisture-wicking Dri-Lex® inner lining
- Nylon shank for additional support when under load of full pack
- SympaTex® waterproof barrier
- Shinyable full-grain leather toe and heel reinforcements
- Abrasion-resistant, non-woven “back counter” reinforcement inside heel
- Washable, antimicrobial, custom-molded OrthoLite® footbed
- Vibram® “Multisport” oil-resistant TC4+ compound outsole with large, open lugs for traction and traversing debris
- Available in Medium (M) and Wide (W) sizes

83BT03 | BK | Men's 4.5 – 6.5M, 7 – 14M or W | \$189.99

Black Ops™ Boots with Composite Toe

- Includes all Black Ops™ Boot features (see above)
- Composite toe and steel shank
- Meets ASTM F2413-05 safety standards
- SympaTex® liner meets ASTM F1671-07 standard for resistance of materials used in protective clothing to penetration by blood-borne pathogens
- Available in Medium (M) and Wide (W) sizes

83BT08 | BK | Men's 4.5 – 6.5M, 7 – 14M or W | \$189.99



Black (BK)



S.A.S. Pro Cut Athletic Socks
WHILE SUPPLIES LAST

- Constructed of 70% polyester, 27% nylon, 2% rubber, 1% spandex
- Moisture-wicking Coolplus® upper
- Low athletic cut
- Blind-side toe stitching for comfort
- Increased support in arch region
- Extra cushioning for protection

83SK04 | WH | Men's 13 – 16 (4 Pack) | \$19.99



S.A.S. Operator Cut Athletic Socks
WHILE SUPPLIES LAST

- Constructed of 50% cotton, 29% polyester, 18% nylon, 2% rubber, 1% spandex
- Moisture-wicking Coolplus® upper
- Breathable mesh layer
- Snug-fitting ankle band
- Blind-side toe stitching for comfort
- Increased support in arch region
- Extra cushioning for protection

83SK05 | WH | Men's 9 – 11 | \$8.99



Lightweight Boot Socks

- Designed especially for use in warm to cool weather
- 20% Coolmax®, 20% wool, 20% cotton, 20% acrylic, 15% polyester, 5% spandex
- 50/50 virgin wool/acrylic blend footbed and heel/Achilles area provide cushioning and blister protection
- Mid-calf design w/ wide elastic calf band
- Anatomic foot design with Y-heel and seamless toe
- Spandex bands at ankle and instep maintain sock's shape and prevent slippage

83SK00 | BK | Men's 9-11, 10-13, 13-16 | \$11.99



Medium Weight Boot Socks

- Designed especially for use in cool to cold weather
- 60% wool, 20% acrylic, 15% polyester, 5% spandex
- 100% virgin merino wool footbed and heel/Achilles area provide warmth, cushioning and blister protection
- Mid-calf design w/ wide elastic calf band
- Anatomic foot design with Y-heel and seamless toe
- Spandex bands at ankle and instep maintain sock's shape and prevent slippage

83SK01 | BK | Men's 9-11, 10-13, 13-16 | \$13.99



Heavyweight Boot Socks

- Designed especially for use in winter weather
- 42% wool, 15% acrylic, 27% polypropylene, 14% nylon, 2% spandex
- 60/40 virgin wool/polypropylene footbed and heel/Achilles area provide warmth, cushioning and blister protection
- 60/40 virgin wool/acrylic shaft dries quickly and keeps you warm
- Mid-calf design with w/ elastic calf band
- Anatomic foot design with Y-heel and seamless toe
- Spandex bands at ankle and instep maintain sock's shape and prevent slippage

83SK02 | BK | Men's 9-11, 10-13, 13-16 | \$15.99



Discreet SOCOM Pistol Case

- Fully modular pouches for custom configurations
- .375" closed-cell foam padding for weapon protection
- TalonFlex™ plastic inserts on top and bottom for stiffness
- High-quality YKK® zippers and dual sliders for security
- Full wraparound carry handles
- Includes universal holster and barrel pouch, sound suppressor pouch, adjustable double mag pouch and UTL light pouch
- Dimensions: 10"L x 13"W x 2.5"D

66SS00 | BK | NSN# 1095-01-521-9352 | \$89.99

Tactical Pistol Lanyard Coiled

- Made with coiled wire and black rubber external laminate
- Attaches to belt with loop or to weapon with gutted 550 cord
- Allows full extension while shooting

Coiled (Non Swivel) | 90TPL1 | BK | \$19.99

Coiled (Single Swivel/Snap Hook/Mini Ring) | 90TPL2 | BK | \$24.99



Gun Rug Pistol Pouch

- Constructed of 1000 denier nylon
- .375" closed-cell foam padding for weapon protection
- High-quality YKK® zippers and dual sliders for security
- Full wraparound carry handles
- Internal padded divider for weapons and accessories
- Elastic keeper for extra magazines
- Dimensions: 12"L x 8"W

61GR01 | BK | NSN# 1095-01-517-6337 | \$28.99





SERPA®

Technology

When it comes to speed and reliability, our patented SERPA® technology guarantees unparalleled performance. The placement of the SERPA Auto Lock™ release reinforces a full master grip by allowing you to draw the weapon normally with the index finger sliding from holster body to weapon frame in one single movement. This proven retention design immediately engages the trigger guard with an audible click as the pistol is holstered, and it won't let go until you release it. [Patented 5,918,784 and/or other patents pending]

Retention Levels

Level 2 SERPA® holsters incorporate two levels of retention: a passive retention detent adjustment screw and patented SERPA Auto Lock™ release. The adjustment screw lets you adjust the force needed to pull the handgun out of the holster after the SERPA Auto Lock is released. Level 3 SERPA holsters incorporate three levels of retention: the same passive retention detent adjustment screw and SERPA Auto Lock release with an added thumb-activated Pivot Guard.



Concealment Duty Duty Light Bearing



With your index finger straight, lay the pad of your finger on top of the SERPA® Auto Lock™ release. Apply gentle pressure against the release with extended index finger flat and straight as you draw.

Materials & Workmanship

We use an injection-molding process to custom mold our SERPA® holsters to the specific weapon model. Constructed of a lightweight, resilient polymer carbon-fiber blend, these durable, impact-resistant holsters retain their rigid shape for rock-solid performance. All SERPA holsters are proudly made in the USA at our Manhattan, Montana facility.

Common Draw Technique

The SERPA® draw technique is common to all holsters in the SERPA family, allowing officers to transition from a simple Level 2 holster to a more elaborate Level 3 holster—using the same draw every time. By reinforcing these learned skills, training time is significantly reduced, and officer safety in high-stress situations is increased.

Carry Positions

We understand that versatility is important to our customers. With a wide range of carry options—on the hip, leg, chest or shoulder—SERPA® holsters are at the ready whenever and wherever needed.

for more:  [youtube.com/bpggear](https://www.youtube.com/bpggear)

Concealment Holsters



SERPA® CQC® Concealment Holster

Featuring our patented SERPA Auto Lock™ release, the SERPA CQC Concealment Holster delivers a smooth draw, easy re-holster and unparalleled weapon security in a sleek package—perfect for concealed carry.

- SERPA® Auto Lock™ release
- Passive retention detent adjustment screw
- Speed-cut design for rapid draw, target acquisition and re-holster
- Includes Belt Loop Platform and Paddle Platform (see page 131)
- Patented (5,918,784 and other patents pending)
- Fits all BLACKHAWK!® injection-molded platforms (see page 128 – 131)
- See Holster Fit Chart on page 150 – 161 for available holster models

4105 | Matte Finish | \$49.99

4100 | Carbon-Fiber Finish | \$59.99



SERPA® CQC® Light Bearing Concealment Holster

This sleek light-bearing holster makes it convenient to carry our BLACKHAWK!® weapon light on a concealed handgun. The light's slim profile creates no added bulk and fits securely in this compact Level 2 holster.

- SERPA® Auto Lock™ release
- Passive retention detent adjustment screw
- Speed-cut design for rapid draw, target acquisition and re-holster
- Includes Belt Loop Platform and Paddle Platform (see page 131)
- Accommodates Night-Ops® Xiphos™ NTX Weapon Mounted Light only (sold separately, see page 112)
- Patent pending
- Fits all BLACKHAWK!® injection-molded platforms (see page 128 – 131)
- See Holster Fit Chart on page 150 – 161 for available holster models

41450 | Matte Finish | \$49.99



Night-Ops® Xiphos™ NTX
Weapon Mounted Light
(sold separately)



SERPA® CQC® Sportster® Holster

Designed for civilian concealed carry or range use, the SERPA CQC Sportster Holster is constructed of injection-molded polymer for long-lasting durability. It features the same dependable SERPA technology but is specifically tailored for low-threat civilian operation.

- SERPA® Auto Lock™ release
- Passive retention detent adjustment screw
- Gunmetal gray holster body with black locking mechanism
- Speed-cut design for rapid draw, target acquisition and re-holster
- Includes paddle platform only
- Patented (5,918,784 and other patents pending)
- Fits all BLACKHAWK!® injection-molded platforms (see page 128 – 131)
- See Holster Fit Chart on page 150 – 161 for available holster models

4135 | Matte Finish | \$33.99



Law enforcement and military personnel looking for a concealment holster should use the original SERPA® CQC® Concealment Holster for high-threat environments.

Duty Holsters



SERPA® Level 2 Auto Lock™ Duty Holster

Featuring a unique jacket-slot belt-loop design, the SERPA Level 2 Auto Lock Duty Holster gives the tactical operative and patrol officer the option of SERPA's retention and speed in a duty-style holster. Wear it as part of your duty rig or as a belt-mounted holster for tactical use.

- SERPA® Auto Lock™ release
- Passive retention detent adjustment screw
- Full-length holster body protects rear sights
- Includes Jacket Slot Duty Belt Loop (see page 131)
- Mid-Ride Duty Belt Loop and High-Ride Duty Belt Loop also available (sold separately, see page 131)
- Patented (5,918,784 and other patents pending)
- Fits all BLACKHAWK!® injection-molded platforms (see page 128 – 131)
- See Holster Fit Chart on page 150 – 161 for available holster models

for more: **You Tube**
youtube.com/bpggear

44H0 | Matte Finish | \$87.99

SERPA® Level 3 Auto Lock™ Duty Holster

Level 3 retention holsters have long been the standard for law enforcement duty use. Now, thanks to the proven SERPA technology, you can draw your weapon rapidly under stress, using your natural drawing motion with no unnatural maneuvers or complicated sequences to remember. Just grab and draw!

- SERPA® Auto Lock™ release
- Passive retention detent adjustment screw
- Thumb-activated Pivot Guard for additional security
- Full-length holster body protects rear sights
- Includes Jacket Slot Duty Belt Loop (see page 131)
- Mid-Ride Duty Belt Loop and High-Ride Duty Belt Loop also available (sold separately, see page 131)
- Patented (5,918,784 and other patents pending)
- Fits all BLACKHAWK!® injection-molded platforms (see page 128 – 131)
- See Holster Fit Chart on page 150 – 161 for available holster models



Pivot Guard won't close accidentally and prevent you from re-holstering your pistol



Basketweave Finish

44H1 | BK | Matte Finish | \$107.99

44H1 | PL | Plain Finish | \$124.99

44H1 | BW | Basketweave Finish | \$124.99



SERPA® Level 3 Light Bearing Auto Lock™ Duty Holster

Featuring our highest level of security, the Level 3 Light Bearing Duty Holster makes it possible to wear a weapon-mounted light while on duty.

- SERPA® Auto Lock™ release
- Passive retention detent adjustment screw
- Thumb-activated Pivot Guard for additional security
- Full-length holster body protects rear sights
- Includes Jacket Slot Duty Belt Loop (see page 131)
- Mid-Ride Duty Belt Loop and High-Ride Duty Belt Loop also available (sold separately, see page 131)
- Accommodates Night-Ops® Xiphos™ NTX Weapon Mounted Light only (sold separately, see page 112)
- Fits all BLACKHAWK!® injection-molded platforms (see page 128 – 131)
- See Holster Fit Chart on page 150 – 161 for available holster models



Night-Ops® Xiphos™ NTX
Weapon Mounted Light
(sold separately)



44H5 | BK | Matte Finish | \$107.99

44H5 | PL | Plain Finish | \$124.99

44H5 | BW | Basketweave Finish | \$124.99

Holster Tip: Increase your holster's versatility with the popular SERPA® Quick Disconnect System! See page 127.



Epoch™

Technology

Building on our track record of reliable holster performance, the new Epoch (pronounced “EP-uhk”) Holster delivers three levels of weapon retention for our highest level of security. The patent-pending retention system engages the pistol’s ejection port when holstered and won’t let go until you release it. As an added safety measure, the Pivot Guard opens by thumb activation and is designed so it won’t close accidentally, locking you out of the holster. This unique design accommodates the most popular under-barrel lights on the market today, giving you all the versatility you’ve come to expect from BLACKHAWK!®.

Function

Reinforcing learned skills by focusing on proper grip is a signature of BLACKHAWK!® holster design. The placement of the Epoch Auto Lock release and outboard index finger indent reinforce a full master grip by allowing the shooter to draw the firearm with the index finger and thumb in proper alignment.

Epoch™ Level 3 Light Bearing Duty Holster **NEW!**

- Constructed of proprietary polymer carbon-fiber blend
- Passive retention detent screw
- Epoch™ Auto Lock thumb release (patent pending)
- Thumb-activated Pivot Guard and Ejection-Port Lock
- Fits popular lights (TLR-1, TLR-2, X300 and X400)
- Reinforces full master grip
- No snaps or hoods to accidentally open
- Includes Jacket Slot Duty Belt Loop (see page 131)
- Mid-Ride Duty Belt Loop and High-Ride Duty Belt Loop also available (sold separately, see page 131)
- Fits all BLACKHAWK!® injection-molded platforms (see page 128 – 131)
- See Holster Fit Chart on page 150 – 161 for available holster models

44E0 | BK | Matte Finish | \$107.99

44E0 | BW | Basketweave Finish | \$124.99

44E0 | PL | Plain Finish | \$124.99



The Epoch™ Holster lets you carry your handgun with the most popular under-barrel lights on the market, including the TLR-1, TLR-2, X300 or X400!

Tactical Holsters

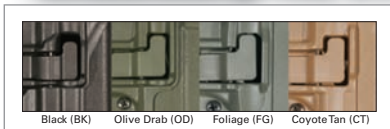

SERPA® Level 2 Tactical Holster

Made specifically to meet the demands of tactical operations, the Level 2 Tactical Holster gives you the benefits of a drop-leg configuration for ideal holster location.

- SERPA® Auto Lock™ release
- Passive retention detent adjustment screw
- Full-length holster body protects rear sights
- Flexible thigh platform conforms to leg size
- Y-harness suspension system distributes weight evenly, keeps holster in vertical position and allows use of pant pocket
- Quick-disconnect swivel buckles for quick holster mounting/dismounting
- Accessory mounting points for pouches, knives, mag cases, etc.
- Hole in holster body for optional bungee retention
- Rubberized leg straps eliminate sliding
- Patented (5,918,784 and other patents pending)
- Fits all BLACKHAWK!® injection-molded platforms (see page 128 – 131)
- See Holster Fit Chart on page 150 – 161 for available holster models

4305 | Matte Finish | \$137.99



SERPA® Level 3 Tactical Holster

The SERPA Level 3 Tactical Holster is our highest level of function, retention and security—perfect for high-threat environments and tactical operations.

- SERPA® Auto Lock™ release
- Passive retention detent adjustment screw
- Thumb-activated Pivot Guard for additional security
- Full-length holster body protects rear sights
- Flexible thigh platform conforms to leg size
- Y-harness suspension system distributes weight evenly, keeps holster in vertical position and allows use of pant pocket
- Quick-disconnect swivel buckles for quick holster mounting/dismounting
- Accessory mounting points for pouches, knives, mag cases, etc.
- Rubberized leg straps eliminate sliding
- Patented (5,918,784 and other patents pending)
- Fits all BLACKHAWK!® injection-molded platforms (see page 128 – 131)
- See Holster Fit Chart on page 150 – 161 for available holster models

4306 | Matte Finish | \$159.99

Did you know? In 2011 BLACKHAWK!® secured a contract with the U.S. Marine Corps, delivering over 27,000 SERPA® holster kits to our Marines.



Matte Finish

SERPA® Level 3 Light Bearing Tactical Holster

The Level 3 Light Bearing Tactical Holster makes it possible to wear our BLACKHAWK!® weapon-mounted light during tactical ops. With high-speed draw under stress and immediate lock-in upon re-holster, this light-bearing holster is ideal for even the most threatening tactical environments.

- SERPA® Auto Lock™ release
- Passive retention detent adjustment screw
- Thumb-activated Pivot Guard for additional security
- Full-length holster body protects rear sights
- Flexible thigh platform conforms to leg size
- Y-harness suspension system distributes weight evenly, keeps holster in vertical position and allows use of pant pocket
- Quick-disconnect swivel buckles for quick holster mounting/dismounting
- Accessory mounting points for pouches, knives, mag cases, etc.
- Rubberized leg straps eliminate sliding
- Accommodates Night-Ops® Xiphos™ NTX Weapon Mounted Light only (sold separately, see page 112)
- Fits all BLACKHAWK!® injection-molded platforms (see page 128 – 131)
- See Holster Fit Chart on page 150 – 161 for available holster models



Night-Ops® Xiphos™ NTX
Weapon Mounted Light
(sold separately)

4307 | Matte Finish | \$159.99

SERPA® Quick Disconnect System

The SERPA Quick Disconnect System allows you to move your SERPA holster effortlessly from one SERPA platform to another while keeping your weapon securely holstered. As mission requirements change, this revolutionary system delivers rapid platform transitions and complete 360-degree angle adjustment with no tools required. Quickly transfer your weapon from a drop-leg platform, belt loop or vest to vehicle, bedside table or closet in a matter of seconds.

for more: [YouTube](https://www.youtube.com/bpggear)
youtube.com/bpggear

The SERPA® Quick Disconnect System is compatible with all injection-molded holster platforms. See page 128 – 131.

Male Adapter

Female Adapters



SERPA® Quick Disconnect System Kit

The SERPA Quick Disconnect System Kit includes two Female Adapters and one Male Adapter. Simply mount a Female Adapter to any solid surface and connect the Male Adapter to your SERPA Holster. Snap the Male Adapter into the Female Adapter and turn clockwise for a secure fit. To release the holster, lift the quick-disconnect tabs and turn counterclockwise.

SERPA® Quick Disconnect System Kit | 430950 | BK, CT, FG, OD | \$41.99

SERPA® Male Adapter (One) | 430951 | BK, CT, FG, OD | \$9.99

SERPA® Female Adapter (Two) | 430952 | BK, CT, FG, OD | \$8.99



Injection-Molded Holster Platforms and Accessories

Tactical Holster Platform

Take your BLACKHAWK!® injection-molded concealment or duty holster and mount it to our Tactical Holster Platform for convenience and reliability during raids or other special ops.

- Flexible thigh platform conforms to leg size
- Y-harness suspension system distributes weight evenly, keeps holster in vertical position and allows use of pant pocket
- Quick-disconnect swivel buckles for quick holster mounting/dismounting
- Rubberized leg straps eliminate sliding
- Accessory mounting points for pouches, knives, mag cases, etc.
- Requires Duty Accessory Mounting Screw Kit (sold separately, see page 239) for mounting BLACKHAWK!® Duty Gear accessories (sold separately, see page 89 – 93)
- Accommodates BLACKHAWK!® Injection-molded concealment or duty holsters (sold separately, see page 121 – 125)

432000P | BK, CT, FG, OD | NSN# 8465-01-529-7439 (CT), NSN# 8465-01-529-7440 (OD) | \$64.99



Versa-Harness™ Holster/Accessory Platform **NEW!**

This versatile chest-mount platform is designed to carry items securely, giving you quick access while backpacking or hiking. Mount your holster, camera case or binocular case quickly using the mounting plate or five-position molded hole pattern.

- Injection-molded multi-position mounting disk with mounting plate and direct-mounting five-position hole pattern
- Ergonomic aero foam shoulder harness
- Nylon webbing with quick-detach buckles
- Compatible with BLACKHAWK!® nylon holsters, injection-molded holsters and SERPA Quick Disconnect System adapters
- One size fits most

44CH00 | BK | \$69.99



Shoulder Harness Holster Platform

In response to countless requests for a SERPA® holster shoulder rig, we developed this comfortable shoulder harness platform for convenient weapon carry. It's constructed using a tapered, fully adjustable web harness and an offside dual Picatinny rail platform for accessories.

- Mount your BLACKHAWK!® injection-molded holster to underarm platform in horizontal position
- Enables one-handed re-holstering (right or left hand)
- Medium (41SH00) fits shirt size Medium to XL
- Large (41SH01) fits shirt size XL to 3XL

Medium | 41SH00 | BK | R or L | \$57.99

Large | 41SH01 | BK | R or L | \$57.99



Holster not included



S.T.R.I.K.E.® Platform

- Ambidextrous adapter platform
- Constructed of injection-molded polymer carbon-fiber blend
- Designed to fit any BLACKHAWK!® injection-molded concealment holster (sold separately, see page 121 – 122) at any angle
- Holds rail-mounted accessories (mag cases, light cases, knife sheaths, etc.)
- Can be mounted to any S.T.R.I.K.E.® or PALS/MOLLE platform
- Does not include holster



38CL63 | BK, CT, FG, OD | NSN# 8465-01-555-1506 (CT) | \$16.99

S.T.R.I.K.E.® Platform with SERPA® Holster (Beretta Only)

- Ambidextrous adapter platform
- Constructed of injection-molded polymer carbon-fiber blend
- Designed to fit SERPA® CQC® Concealment Holster for Beretta M9/92/96 (not Elite, Brigadier or M9A1) at any angle
- Can be mounted to any S.T.R.I.K.E.® or PALS/MOLLE platform
- Holster included



40CL01 | FG, OD, CT | R or L | NSN# 1095-01-533-3016 (OD-R), NSN# 1095-01-533-3015 (OD-L) | \$52.99

Concealment Vest Holster Platform

This hook-backed mounting platform allows you to mount your injection-molded holster inside loop-lined fanny packs, concealment vests or BLACKHAWK!® carry bags.

411500 | BK | \$19.99



Carbon-Fiber Holster Spacer Kit

Whether you need to compensate for bulky body armor or hip-to-waist contours, these spacer kits let you adjust the angle or distance away from the body of any BLACKHAWK!® injection-molded holster.

- Concealment Holster Spacer Kit (411400C) includes two spacers and eight 32-screws for concealment holsters
- Tactical/Duty Holster Spacer Kit (411401C) includes one spacer and ten 32-screws for tactical and duty holsters



Concealment | 411400C | BK | \$15.99

Tactical/Duty | 411401C | BK | \$10.99



Slot with adjustment to determine ride/height

Concealment Carbon-Fiber Multi-Functional Belt Loop

This clever belt loop turns your BLACKHAWK!® injection-molded concealment holster into a semi-pancake holster with its three-slot design and adjustable-width belt slots.

- Designed to fit BLACKHAWK!® injection-molded concealment holster for Glock models only (sold separately, see page 121 – 122)
- Three-slot design allows for strong-side, cross-draw or appendix carry

410900C | BK | \$22.99



SERPA® Holster Bungee Retention Strap

Perfect for three-gun matches or other extreme ops, this bungee retention system features a high-strength shock cord for additional weapon security.

- Secure to holster with girth hitch or knot and snap over pistol back strap
- Designed to fit SERPA® Level 2 Tactical Holster (sold separately, see page 126)
- Can be cut to length

40BR00 | BK | \$9.99

Shoulder Harness

Belt Loop Platform

S.T.R.I.K.E.® Platform with SERPA® Holster

Tactical Holster Platform



SERPA® S.T.R.I.K.E.® Combo Kit (Beretta Only)

The S.T.R.I.K.E. Platform lets you securely mount a SERPA holster to your MOLLE vest while the shoulder harness, thigh platform and belt loop give you the option to wear your holster in a variety of positions. The shoulder harness is available in black only.

- Designed to fit SERPA® CQC® Concealment Holster for Beretta M9/92/96 (not Elite, Brigadier or M9A1)
- Includes Tactical Holster Platform (see page 128)
- Includes S.T.R.I.K.E.® Platform with SERPA® Holster (see page 127)
- Includes Shoulder Harness Holster Platform (see page 128)
- Includes Belt Loop Platform (see page 131)
- Medium (40SC02) fits shirt size Medium to XL
- Large (40SC03) fits shirt size XL to 3XL

Medium | 40SC02 | CT, FG | R or L | \$186.99

Large | 40SC03 | CT, FG | R or L | \$186.99

Paddle Platform with Screws

- Designed to fit any BLACKHAWK!® injection-molded concealment holster (sold separately, see page 121 – 122)

410902 | BK | \$13.99



Belt Loop Platform with Screws

- Designed to fit any BLACKHAWK!® injection-molded concealment holster (sold separately, see page 121 – 122)

410901 | BK | \$11.99



High-Ride Duty Belt Loop with Screws

- Designed to fit any BLACKHAWK!® injection-molded duty holster (sold separately, see page 123 – 125)
- Moves holster higher on duty belt
- Fits 2" and 2.25" duty belts

44H900 | BK | \$13.99



Jacket Slot Duty Belt Loop with Screws

- Designed to fit any BLACKHAWK!® injection-molded duty holster (sold separately, see page 123 – 125)
- Attach holster to duty belt without unthreading other gear
- Fits 2" and 2.25" duty belts

44H901 | BK | \$17.99



Mid-Ride Duty Belt Loop with Screws

- Designed to fit any BLACKHAWK!® injection-molded duty holster (sold separately, see page 123 – 125)
- Moves holster higher on duty belt
- Fits 2" and 2.25" duty belts

44H902 | BK | \$17.99



Mod-U-Lok™ Platform with Screws

- Designed to fit any BLACKHAWK!® injection-molded concealment holster (sold separately, see page 121 – 122)
- Quick disconnect belt loop
- Attach holster to duty belt without unthreading other gear
- One-handed release from belt
- Positive engagement keeps belt loop in place
- Includes spacer for use with narrower belts
- Fits belts up to 2.25" wide

410904 | BK | \$18.99

Leather Holsters

Italian Leather

Leather manufacturers in Italy are well-known for producing extremely high-end products. That's why we use premium Italian cowhide leather—the finest material we could get our hands on.

Vegetable Tanned

We use a plant-based “tannin” compound for the tanning process, giving each holster a natural finish.

Drum Dyed

The leather is placed in a huge barrel-shaped drum and tumbled with the dye for 24 to 48 hours. This forces the dye into the leather for long-lasting results.

GripBreak™ Leather Holster **NEW!**

The GripBreak Leather Holster's patented locking mechanism offers secure weapon retention in a premium Italian leather design. Maintain a master grip and quick, smooth draw thanks to a simple thumb release lever.

- Constructed of premium drum-dyed Italian leather
- Inner molded shell
- Patented automatic locking system holds firearm in place
- Fits belts up to 1.75" wide
- Molded release guard
- See Holster Fit Chart on page 150 – 161 for available holster models

4219 | BK | \$76.99

Suede Leather Tuckable Holster **NEW FITS!**

Completely conceal your pistol without having to wear a cover garment or an untucked shirt. The inconspicuous belt clip slides onto your pants while your weapon stays tucked under your shirt.

- Smooth interior for easy draw
- Rough-side outer material for non-slip fit
- Fits belts up to 1.75" wide
- New design offers more holster “footprint” to better stabilize firearm
- Repositioned belt clip for less bulk and better concealment
- See Holster Fit Chart on page 150 – 161 for available holster models

4216 | BN | \$38.99

Suede Leather Angle Adjustable ISP Holster **NEW!**

Made using top-quality suede leather, this inside-the-pants holster is equipped with an angle-adjustable belt clip so you can position your firearm for better concealment and comfort.

- Smooth interior for easy draw
- Rough-side outer material for non-slip fit
- Fits belts up to 1.75" wide
- Injection-molded angle-adjustable belt clip for cant adjustment
- See Holster Fit Chart on page 150 – 161 for available holster models

42180 | BN | \$34.99

Contour Stitched

We build our holsters by closely stitching along the outline of the pistol. Not only does this result in a better fit and appearance, but it's one of the telling marks of a well-made leather holster.

Hand Boned

Leather holsters were traditionally shaped to a particular pistol with a small animal bone. Modern metal or plastic tools have replaced bones, but the term is still used. We use this technique to give our holsters a sculpted outline.

Hand Polished

As a final touch, we use a finishing cream to seal in the dye and create a nice lustrous shine.



Leather Tuckable Pancake Holster NEW!

Constructed of premium leather and molded Kydex®, this holster combines the benefits of three holsters in one, giving you the option of inside-the-pants, tuckable or belt-mounted wear. No matter how you choose to wear it, each design will contour to your body for exceptional comfort and concealment.

- Three-slot design for behind-the-hip, strong-side, cross-draw or appendix carry (for belt carry)
- Injection-molded removable/angle-adjustable belt clips for cant and ride height adjustment (for inside-the-pants carry)
- Belt clips designed for traditional inside-the-pants wear or use as tuckable holster under shirt
- Fits belts up to 1.5" wide
- Adjustable tension screw for customized retention
- Covered trigger guard for safety and security
- Built-in shirt shield increases comfort and repels moisture
- See Holster Fit Chart on page 150 – 161 for available holster models

4220 | BK | \$84.99

**Leather 3-Slot Pancake Holster**

This molded three-slot holster comfortably contours to your body, providing exceptional concealment for your weapon.

- Covered trigger guard for safety and security
- Reinforced thumb break for durability and ease of draw
- Three-slot design allows for behind-the-hip, strong-side, cross-draw or appendix carry
- See Holster Fit Chart on page 150 – 161 for available holster models

4200 | BK, BN | \$65.99

**Leather Detachable Slide Holster**

This update to the well-known slide design lets you attach and detach the holster to your belt in a matter of seconds. Angle-cut belt loops wrap around your belt and are secured with sturdy snaps, so you never have to undo your belt to configure the holster!

- Covered trigger guard for safety and security
- Adjustable thumb break for various weapon sizes
- Angle-cut belt loops fit a variety of belt widths
- Non-reflective black snap covers
- See Holster Fit Chart on page 150 – 161 for available holster models

4201 | BK | \$78.99





Leather Inside-the-Pants Holster with Clip

Designed for deep concealment, this inside-the-pants holster will keep your weapon out of the way and out of sight.

- High inner body provides moisture barrier and protects body from sharp edges
- See Holster Fit Chart on page 150 – 161 for available holster models

4214 | BN | \$59.99



Leather Slide Holster with Thumb Break

This compact leather holster gives you a minimalist profile with the added security of a thumb break.

- Dual belt slots pull holster body close for maximum concealment
- Open-bottom design accommodates various weapon lengths
- See Holster Fit Chart on page 150 – 161 for available holster models

4211 | BN | \$56.99



Leather Multi-Position Holster

This classic belt scabbard allows you to wear your handgun either strong-side or cross-draw and is the perfect holster for your large-frame revolver.

- See Holster Fit Chart on page 150 – 161 for available holster models

42120 | BN | \$86.99

Leather Yaqui Slide Holster

The traditional Yaqui Slide Holster gives you the least amount of holster for light, comfortable carry.

- Open-bottom design accommodates various weapon lengths
- Adjustable tension screw for customized retention
- See Holster Fit Chart on page 150 – 161 for available holster models

42150 | BN | \$54.99

**Leather Hip Scabbard Holster**

Whether in the field, on the range or on the hunt, this traditional hip scabbard with thumb break gives you a comfortable, low-ride holster with a classic thumb break for peace of mind.

- See Holster Fit Chart on page 150 – 161 for available holster models

42170 | BN | \$65.99

**Leather Cutaway Holster**

The Cutaway Holster combines the reliability of a thumb break with the rapid draw of a cut-down front to give you both speed and security in one package. The widely separated belt slots provide a close fit with a minimum of printing.

- See Holster Fit Chart on page 150 – 161 for available holster models

42130 | BN | \$69.99





Passive retention adjustment screw



Butt forward



Vertical cant

Leather Compact Slide Holster with Mag Pouch

This holster is no bigger than most slide holster designs, but it gives you the added benefit of having a spare mag at your fingertips. Its flex design hugs the waistline and offers a snug fit.

- Covered trigger guard for safety and security
- Molded detent helps keep magazine in place
- Adjustable tension screw for customized retention
- Open-bottom design accommodates various weapon lengths
- Available for single-stack and double-stack model pistols
- Rear belt loop and dual front belt loop allow for strong-side, cross-draw, or appendix carry
- See Holster Fit Chart on page 150 – 161 for available holster models

4202 | BK | \$69.99



Passive retention adjustment screw

Leather Check-Six™ Holster

When employing a long gun as the primary weapon, this holster's position is perfect for your handgun because it won't interfere with the operation of your long gun. Sitting securely just behind the hip, the Check Six Holster gives you options, comfort, and speed.

- Designed to hold handgun close to natural contour of the waist
- Flat holster back protects body from sharp edges
- Adjustable tension screw for customized retention
- See Holster Fit Chart on page 150 – 161 for available holster models

4207 | BK | \$66.99



Leather Speed Classic

Put simply, the Leather Speed Classic is a small holster for a small handgun. With this adaptation of the famous Berns-Martin design, you'll never have to worry about clumsy draws or unreliable retention again.

- Trailing belt loop pulls holster in tight to body
- Available for most 2" and 2-1/8" S&W, Ruger®, Taurus® and other 5-shot revolvers
- See Holster Fit Chart on page 150 – 161 for available holster models

420800 | BK, BN | \$46.99

Leather Inside-the-Pants Holster

Whether you're undercover or off duty, the inconspicuous Leather Inside-the-Pants Holster is the perfect choice for a secondary weapon or deep concealment.

- Angle-adjustable belt loop mounted to reinforced upper body for stability
- Adjustable tension screw for customized retention
- Built-in shirt shield increases comfort and keeps sweat away from gun
- Inside-the-pants design allows for middle-of-the-back, strong-side, cross-draw or appendix carry
- Less bulk than most leather inside-the-pants holsters
- Injection-molded sight track for smooth draw and re-holster
- See Holster Fit Chart on page 150 – 161 for available holster models

4204 | BK | \$66.99



Leather Compact Askins Holster

Featuring a minimalist design, the Leather Compact Askins Holster offers versatility and comfort in a high-quality package.

- Belt loop keeps handgun close to waist
- Trailing belt loop pulls holster in tight to body
- Injection-molded sight track for smooth draw and re-holster
- Adjustable tension screw for customized retention
- Reinforced opening for consistent ease in re-holstering
- Accommodates full-size or compact model handguns
- See Holster Fit Chart on page 150 – 161 for available holster models

4205 | BK, BN | \$64.99



Nylon Holsters

Here at BLACKHAWK!®, we believe that quality is paramount. That's why we construct each of our nylon holsters with an ultra-thin, three-layer nylon laminate base material. Many are then covered with hardwearing CORDURA®—the gold standard of nylon material—for outstanding abrasion and fade resistance. Others feature a velvet-like laminate suede outer material, giving the holsters a soft, suede-like appearance and texture.

GripBreak™ Nylon Holster **NEW!**

The GripBreak Nylon Holster offers a unique retention experience in a sturdy nylon package. An automatic locking mechanism securely holds the firearm in place while a simple thumb release lever helps you maintain a master grip for a quick, smooth draw.

- Constructed of 1000 denier CORDURA® nylon outer material
- Inner molded shell
- Patented automatic locking system holds firearm in place
- Fits belts up to 1.75" wide
- Molded release guard
- See Holster Fit Chart on page 150 – 161 for available holster models

40GB | BK | \$39.99



Nylon S&W X-Frame Hip Holster **NEW!**

Designed for handgun hunters or sport shooters, this hip holster gives you quick access to your Smith & Wesson® revolver.

- Constructed of 1000 denier CORDURA® nylon outer material
- Nylon web sight channel
- Nylon web strap holds firearm in place
- See Holster Fit Chart on page 150 – 161 for available holster models

73NH20 | BK | \$27.99



Nylon Alaska Guide Holster **NEW!**

Built with robust nylon, the Alaska Guide Holster is designed for long-lasting durability and performance—perfect for professional guides, sportsmen or backpackers who need a firearm within reach.

- Constructed of durable 1050 denier ballistic nylon
- Adjustable harness system (one size fits most)
- Can be worn in a vertical, horizontal or angled position
- Revolver model (40AG01BK) includes a speed loader pouch and cartridge loops and fits large-frame revolvers (e.g. Ruger® Alaskan, S&W 629)
- Pistol model (40AG02BK) includes a magazine pouch and fits large-frame handguns (e.g. Gov't 1911 and variants)
- Quick-release retention strap keeps handgun secure

Revolver | 40AG01 | BK | \$79.99

Pistol | 40AG02 | BK | \$79.99



Nylon Askins Style Hip Holster **NEW!**

Combining the popular Askins design with our multi-size, ambidextrous holster fit, the Nylon Askins Style Hip Holster rides close to the hip, making it the perfect choice for concealed carry.

- Ambidextrous design
- Constructed of 1000 denier CORDURA® nylon outer material
- Adjustable/removable molded thumb break and release strap
- Fits belts up to 1.75" wide
- Made in the USA
- See Holster Fit Chart on page 150 – 161 for available holster models

40NA | BK | \$29.99



Nylon Bedside Holster

With the ambidextrous Nylon Bedside Holster, you can rest easy knowing that your holstered handgun is nearby for quick access.

- Ambidextrous design
- Constructed of 1000 denier CORDURA® nylon outer material
- Mounting platform slips between mattress and box springs
- Holds pistol beside bed for rapid access
- Works with revolvers and semi-autos
- Non-slip material on mounting platform for added stability
- Universal-fit holster accommodates most handguns

40BH00 | BK | \$34.99



Nylon Day Planner Holster

Conceal your handgun and spare mag in a holster that's designed to mimic an ordinary day planner.

- Constructed of 1000 denier CORDURA® nylon outer material
- External appearance of a day planner
- Simple design eliminates needless bulk
- Conceals small/medium or large handguns
- Multi-fit holster design allows exact fit to desired gun
- Spare mag holder carries extra ammunition
- Double zipper opening

Small/Medium | 40DP00 | BK | \$64.99
Large | 40DP01 | BK | \$69.99



Nylon Scoped Pistol Bandolier Holster

The Nylon Scoped Pistol Bandolier Holster is ideal for carrying large scoped hunting or target guns across your chest or back.

- Constructed of 1000 denier CORDURA® nylon outer material
- Adjustable, padded shoulder strap and belt loop
- Removable, adjustable, padded flap protects gun in all weather
- Retention strap included
- See Holster Fit Chart on page 150 – 161 for available holster models

40SB | BK | \$63.99



Nylon Vertical Shoulder Holster

Comfortably carry your firearm in the vertical position while achieving excellent concealment.

- Constructed of 1000 denier CORDURA® nylon outer material
- CORDURA® nylon outer shell and waterproof closed-cell foam padding
- Offside tie-down with dual Picatinny rail platform for accessories
- Adjustable, non-stretch retention strap with molded finger break
- Fits handguns with scopes (40SV) or without scopes (40VH)
- See Holster Fit Chart on page 150 – 161 for available holster models

Without Scope (Size 00 – 06) | 40VH | BK | \$43.99

Without Scope (Size 11 – 15) | 40VH | BK | \$46.99

With Scope | 40SV | BK | \$51.99



Nylon Horizontal Shoulder Holster

Keep your handgun out of sight with the lightweight Nylon Horizontal Shoulder Holster.

- Constructed of 1000 denier CORDURA® nylon outer material
- Offside plate for optional accessories
- Non-stretch retention strap with molded thumb break
- See Holster Fit Chart on page 150 – 161 for available holster models

40HS | BK | \$56.99



Nylon Compact Belt Slide Holster

This compact, open-top holster design is ideal for daily wear and features dual belt loops that pull the holster close to the body for optimum concealment.

- Ambidextrous design
- Constructed of 1000 denier CORDURA® nylon outer material
- Nylon web belt loops fit belts up to 1.5" wide
- Elastic firearm retainer tab wraps over hammer for secure retention
- Fits most autos and revolvers
- See Holster Fit Chart on page 150 – 161 for available holster models

40CS | BK | \$21.99



Nylon Hip Holster with Thumb Break

Featuring a non-stretch retention strap with molded thumb break, the Nylon Hip Holster gives you the security you need to carry with confidence.

- Constructed of 1000 denier CORDURA® nylon outer material
- Laminate construction for waterproof protection
- Dual-slot belt loops for duty, sport or dress belts
- See Holster Fit Chart on page 150 – 161 for available holster models

40HT | BK | \$25.99



Nylon Paddle Holster

The Nylon Paddle Holster completely encloses the trigger guard while a non-stretch retention strap with molded thumb break keeps your pistol in place until you're ready to draw.

- Constructed of 1000 denier CORDURA® nylon outer material
- Paddle adjusts for vertical, butt-forward or muzzle-forward carry
- See Holster Fit Chart on page 150 – 161 for available holster models

40PH | BK | \$41.99

Nylon Angle Draw Shoulder Holster

Whether you're carrying concealed on or off duty, you can draw quickly and efficiently with the Nylon Angle Draw Shoulder Holster's 45-degree set angle.

- Ambidextrous design
- Constructed of 1000 denier CORDURA® nylon outer material
- Twin spare mag carriers for extra ammo storage
- Dual-retention thumb snap and adjustable belt attachment strap
- One size fits most (small-, medium- and large-frame weapons)

40SH00 | BK | Size 00 | \$61.99



Nylon Ambidextrous Shoulder Holster

This fully ambidextrous holster lets you conceal your pistol while carrying two extra magazines on the same shoulder harness system.

- Ambidextrous design
- Constructed of 1000 denier CORDURA® nylon outer material
- Adjustable thumb break fits most standard autos
- TalonFlex™ inserts stiffen holster for quick, efficient draw and re-holstering
- Includes double mag pouch, shoulder harness, holster and belt-securing attachments
- Fits 4" barrel and intermediate semi-auto pistols

40SH02 | BK | Size 02 | NSN# 8465-01-520-7278 | \$69.99



Quick Tip: You can easily clean your CORDURA® nylon holster with a small amount of mild laundry detergent in warm water. Wash by hand and let air dry.

Nylon Universal Spec Ops Pistol Harness

Wear the Nylon Universal Spec Ops Pistol Harness cross-body in the vertical, horizontal or angled position.

- Constructed of 1000 denier CORDURA® nylon outer material
- Padded and fully adjustable
- Fits most semi-auto pistols
- Right-hand model only

40SH01 | BK | Size 04 | \$69.99





Nylon 3-Slot Pancake Holster

This three-slot pancake design gives you the option of strong-side, kidney or cross-draw mounting options while a reversible/adjustable retention strap with molded thumb break provides reliable weapon security.

- Ambidextrous design
- Constructed of 1000 denier CORDURA® nylon outer material
- Lined with smooth, snag-resistant material
- Belt slots pull holster body close for maximum concealment
- Fits belts up to 1.75" wide
- See Holster Fit Chart on page 150 – 161 for available holster models

40PC | BK | \$27.99



Nylon TASER® C2 Holster

With 1/8" padding and rugged CORDURA® construction, this holster lets you carry your Civilian TASER® C2 securely in a lightweight package.

- Constructed of 1000 denier CORDURA® nylon outer material with 1/8" padding
- Retention strap with snap thumb break
- Molded belt loop
- Weight: 1.6 oz.
- Fits Civilian TASER® C2

40C200 | BK | \$24.99



Nylon Laser Holster

The Nylon Laser Holster conveniently carries popular-sized pistols with most under-barrel laser systems.

- Constructed of 1000 denier CORDURA® nylon outer material
- See Holster Fit Chart on page 150 – 161 for available holster models

40LH | BK | \$24.99



Nylon Hip Holster

Featuring smooth nylon lining and robust outer shell, this holster is designed for easy draw and unyielding performance.

- Constructed of 1000 denier CORDURA® nylon outer material
- Smooth nylon lining for easy draw
- Adjustable retention strap with non-glare snaps
- See Holster Fit Chart on page 150 – 161 for available holster models

73NH | BK | \$17.99

Nylon Inside-the-Pants Holster

Our popular inside-the-pants design is soft to the touch and easy to draw thanks to its laminate suede outer shell and smooth nylon lining.

- Constructed of soft laminate suede outer material
- Smooth nylon lining for easy draw
- Belt clip slips over pants or belt to retain holster
- Fold-over hook & loop retention strap (73IR0 only)
- See Holster Fit Chart on page 150 – 161 for available holster models

Without Retention Strap | 73IP | BK | \$12.99

With Retention Strap | 73IR | BK | \$18.99



Nylon Ankle Holster

Made with soft knit fabric, the Nylon Ankle Holster keeps your pistol under wraps while providing comfortable next-to-skin wear.

- Constructed of 1000 denier CORDURA® nylon outer material
- Closed-cell foam padding protects pistol from moisture
- Non-stretch retention strap with molded thumb break
- See Holster Fit Chart on page 150 – 161 for available holster models

40AH | BK | \$39.99



Nylon Ambidextrous Multi-Use Holster With Mag Pouch

This versatile, fully ambidextrous holster gives you the option of belt-mounted or inside-the-pants configurations.

- Constructed of 1000 denier CORDURA® nylon outer material
- Removable spring-steel clip
- Reversible, non-stretch hook & loop retention strap with molded thumb break
- Fits belts up to 1.75" wide in a traditional vertical position
- Fits belts up to 1.5" wide in horizontal position (middle of the back)
- Spare mag pouch with adjustable retention flap
- See Holster Fit Chart on page 150 – 161 for available holster models

40AM | BK | \$29.99



Nylon Inside-the-Pocket Holster

The Nylon Inside-the-Pocket Holster protects your skin from the weapon's sharp edges and provides a moisture barrier thanks to its low-profile laminate suede construction.

- Constructed of soft laminate suede outer material
- Open-top holster provides grip-up positioning
- Non-slip band keeps holster in pocket when firearm is drawn
- See Holster Fit Chart on page 150 – 161 for available holster models

40PP | BK | \$12.99



Nylon Belt Pouch Holster

Looking for the ultimate concealed carry solution? The Nylon Belt Pouch Holster is your ticket to deep concealment thanks to a clever design that mimics a camera or tourist pouch.

- Constructed of 1000 denier CORDURA® nylon outer material
- Top zipper opening can remain open or closed without revealing weapon
- Discreet hook & loop flap inside pouch keeps handgun hidden
- Separate pocket on front of pouch holds keys, cuffs, camera, company patch or other “corporate camouflage”
- Dual belt loops fit belts up to 2” wide
- Mini model (40BP00) fits 2” 5-shot revolvers and sub-compact autos
- Large model (40BP01) fits 3” revolvers and medium- and large-frame autos
- Dimensions: 8”L x 5.5”W x 1”D (Mini), 8.5”L x 7”W x 1.625”D (Large)

Mini | 40BP00 | BK | \$44.99
Large | 40BP01 | BK | \$47.99



Nylon Body Armor Holster

Wear the Nylon Body Armor Holster inside concealable body armor straps, keeping your pistol secure and out of view.

- Ambidextrous design
- Constructed of soft laminate suede nylon
- Moisture-resistant laminate protects weapon from perspiration
- Non-stretch retention strap
- See Holster Fit Chart on page 150 – 161 for available holster models

40BA | BK | \$16.99



Nylon Ambidextrous Flat Belt Holster

The Nylon Ambidextrous Flat Belt Holster hugs tight against your body, offering a low-profile carry option.

- Ambidextrous design
- Constructed of 1000 denier CORDURA® nylon outer material
- Fits belts up to 2” wide
- Adjustable, reversible thumb break
- Fits most small- to medium-frame and medium- to large-frame autos and revolvers

40FB02 | BK | NSN# 1095-01-520-5937 | \$20.99



Nylon Concealed Weapon Fanny Pack Holster

This discreet fanny pack design allows you to carry “hidden in plain sight” thanks to an internal, fully adjustable universal holster with thumb break.

- Constructed of 1000 denier CORDURA® nylon outer material
- Retention belt loops attach to belt for extra security and retention
- Universal holster design fits most small- to medium-frame and medium- to large-frame autos and revolvers

Small | 60WF04 | BK | \$64.99
Medium | 60WF05 | BK | \$64.99
Large | 60WF06 | BK | \$64.99



Nylon Omega™ VI Improved Universal Ambidextrous Drop Leg Holster **NEW!**

The Omega VI Improved Holster is the epitome of functionality, combining our popular universal drop-leg holster with a Y-harness suspension system. Get the best of both worlds with this versatile holster design!

- Ambidextrous design
- Constructed of 500 denier CORDURA® nylon
- Designed primarily for law enforcement officers
- Y-harness drop-leg platform for even weight distribution
- Elastic, rubberized leg straps for stability and comfort
- Adjustable thumb break with retention strap for secure fit
- Fits pistols with or without light or laser aiming module

40ALH1 | BK, CT, AU | \$85.99



Nylon Omega™ VI Ultra Universal Modular Light Holster

Wear this versatile holster in a drop-leg configuration or detach it from the thigh platform for wear on a belt or any S.T.R.I.K.E.® or PALS/MOLLE platform.

- Ambidextrous design
- Constructed of 1000 denier CORDURA® nylon outer material
- Elastic, rubberized leg straps for stability and comfort
- Includes Speed Clips™ (see page 214)
- Three side-release buckles (top and legs) for three-point breakaway
- Front-mounted pouch for extra magazine, knife or light
- Adjustable thumb break with extra hook & loop retention
- Fits pistols with or without light or laser aiming module

40MLH1 | BK, CT, OD, AU | \$106.99



Nylon Omega™ VI Elite Holster

The fully adjustable Omega VI Elite Holster gives you the benefits of a drop-leg platform with quick-release belt mount, rubberized leg straps and three-point breakaway system.

- Constructed of 1000 denier CORDURA® nylon outer material
- Elastic, rubberized leg straps for stability and comfort
- Three side-release buckles (top and legs) for three-point breakaway
- Front-mounted pouch for extra magazine, knife or light
- Removable retention strap
- Adjustable thumb break with extra hook & loop retention
- See Holster Fit Chart on page 150 – 161 for available holster models

40QD | AU, DE, BK | \$85.99



Nylon Special Operations Holster

Featuring a drop-leg platform and adjustable thumb break, the Special Operations Holster keeps your pistol secure even during extreme ops.

- Constructed of 1000 denier CORDURA® nylon outer material
- Elastic, rubberized leg straps for stability and comfort
- Adjustable thumb break for quick draw
- Top flap covers pistol for maximum weapon retention
- Flap secured open by hook & loop or closed by side-release buckle
- Front-mounted pouch for extra magazine, knife or light
- Additional mag pouches can be mounted horizontally on belt flap (pouches not included)
- Fits most semi-auto pistols

40XP00 | OD | Size 00 | NSN# 8465-01-501-8078 | \$64.99



Single Mag Cases

Our carbon-fiber composite Single Mag Cases feature a built-in tension spring to securely hold magazines of various sizes. For two magazines on the same carrier, customers can remove the belt clip and place two Single Mag Cases side-by-side on our Dual Rail Accessory Platform (sold separately, see page 148). The case can also be placed next to one of our light carriers for a combo light/mag carrier.

- Single-stack versions fit 9mm/.40 cal/.45 cal/10mm/.357 Sig
- Double-stack versions fit 9mm/.40 cal

Single Stack | 410500C | BK | Carbon-Fiber Finish | NSN# 8465-01-529-7480 | \$23.99

Single Stack | 410500P | BK, CT, OD, FG | Matte Finish | NSN# 8465-01-529-7481 (BK), NSN# 8465-01-529-7482 (CT), NSN# 8465-01-529-7483 (OD) | \$22.99

Double Stack | 410600C | BK | Carbon-Fiber Finish | NSN# 8465-01-529-7484 | \$23.99

Double Stack | 410600P | BK, CT, OD, FG | Matte Finish | \$22.99



Carbon-Fiber Finish

Black (BK)

Coyote Tan (CT)

Olive Drab (OD)

Foliage Green (FG)



Double Mag Cases

With twice the capacity of our Single Mag Cases, the Double Mag Cases come in both single-column and staggered-column magazine versions. A built-in tension spring securely holds magazines of various sizes while an adjustable belt-clip hook accommodates belts of different widths.

- Includes belt loops and belt clip
- Curved to waistline for slimmer profile
- Single-stack versions fit 9mm/.40 cal/.45 cal/10mm/.357 Sig
- Double-stack versions fit 9mm/.40 cal/.45 cal/10 mm/.357 Sig

Single Stack | 410510C | BK | Carbon-Fiber Finish | \$36.99

Single Stack | 410510P | BK | Matte Finish | \$31.99

Double Stack | 410610C | BK | Carbon-Fiber Finish | \$36.99

Double Stack | 410610P | BK | Matte Finish | \$31.99



TASER® Side Mount Plate

This adapter plate allows you to mount the TASER X26 Cartridge Holder to your TASER X26 Duty Holster and still save space on your duty belt. The unique front side positioning allows for fast reload without taking up too much space on the belt.

- Ideal for officers with small waists
- Perfect for mounting on a crowded MOLLE vest
- Fits duty belts up to 2.25" wide
- Positions spare cartridge to outboard side of TASER® X26 Duty Holster (sold separately) for rapid access
- Available in right- or left-hand models

44H907 | BK | R or L | \$12.99



TASER® X26 Cartridge Holder

- Injection-molded carbon-fiber blend
- Attaches easily to BLACKHAWK® TASER® X26 Duty Holster (sold separately)
- Rapid reload capability
- Mini Mod-U-Lok™ belt loop with adjustable spacer fits most duty belts
- Ambidextrous design

44A890 | BK | \$24.99



Light and mag pouch sold separately

Carbon-Fiber Dual Rail™ Accessory Platform

- High-strength carbon-fiber construction
- Designed for weapon-mounted Picatinny rail lights such as Streamlight® M-3/M-6 family of lights
- Removable M-3 holder
- Available in paddle or belt loop models

Paddle | 410800C | BK | NSN# 8465-01-530-0991 | \$23.99

Belt Loop | 411300C | BK | NSN# 8465-01-530-0990 | \$23.99



Light not included

Carbon-Fiber Pistol Light Carrier

- High-strength carbon-fiber construction
- Designed for weapon-mounted Picatinny rail lights such as Streamlight® M-3/M-6 family of lights
- Fits standard-width belts
- Automatically locks light switch in off position to prevent accidental activation
- Accommodates lens-down carry position to protect lens

411100C | BK | \$16.99



Removable belt clip

Compact Light Carrier

- Designed to hold small, personal-sized lights such as Streamlight® Scorpion, TL-2 or TL-3
- Button recess at bottom prevents accidental light activation
- Built-in tension device provides secure light carry
- Removable belt clip
- Can be mounted to BLACKHAWK!® Carbon-Fiber Dual Rail™ Accessory Platform (sold separately, see top of page)

411000C | BK | Carbon-Fiber Finish | \$22.99

411000P | BK, CT, OD, FG | Matte Finish | NSN# 8465-01-529-5681 (BK), NSN# 8465-01-529-5682 (CT), NSN# 8465-01-529-5680 (OD) | \$21.99

Leather Magazine Pouch

- Fits a variety of weapon magazines
- Integral tension-adjustable screw for tension adjustment (two screws on Double Mag Pouch and one screw on Single Mag Pouch)
- Removable, angle-adjustable belt clip with talon keeps pouch in place (Single Mag Pouch only)
- Multi-position quick-snap belt attachment (Double Mag Pouch only)
- Single-stack versions fit 9mm/.40 cal/.45 cal/10mm
- Double-stack versions fit 9mm/.40 cal

Single Mag Pouch (Single Stack) | 420900 | BK, BN | \$34.99
 Single Mag Pouch (Double Stack) | 420901 | BK, BN | \$34.99
 Double Mag Pouch (Single Stack) | 420902 | BK, BN | \$45.99
 Double Mag Pouch (Double Stack) | 420903 | BK, BN | \$45.99



Vary the angle 30 degrees in either direction on the single mag pouch

Mount our mag cases, light carriers and other holster accessories to the Modular Drop-Leg Platform for a customizable thigh rig platform! See page 250.



Multi-position quick-snap belt attachment



Tactical Mag Pouch

- High-strength carbon-fiber construction
- Mounts directly to SERPA® Tactical Holster Platform (sold separately, see page 128)
- Molded flap with snap retains magazine

430900 | BK, CT, OD, FG | \$22.99



Demonstrator Replica Guns

- Exact size of real pistol
- Injection-molded high-strength, glass-filled polymer
- Available in Gray (GY) or Safety Orange (OR)

44DGGL17 | GY, OR | Glock 17/22/31 | \$30.99
 44DGB92F | GY, OR | Beretta 92/96 | \$30.99
 44DGSWJF | GY | S&W J-Frame | \$30.99
 44DG226R | GY, OR | Sig 226 with Rail | \$30.99
 44DG1911 | GY, OR | Colt 1911 with Rail | \$30.99



Holster Fit Chart

SERPA® CQC® Concealment Holster – Matte Finish				
Model	Color	Part#	Size	NSN#
Glock 17/22/31	Black	410500BK-R or L	00	1095-01-529-7479
Glock 26/27/33	Black	410501BK-R or L	01	
Glock 19/23/32/36	Black	410502BK-R or L	02	8465-01-555-1503 (R), 8465-01-554-1462 (L)
Gov't 1911 and Clones with or without Rails	Black	410503BK-R or L	03	
Gov't 1911 and Clones with or without Rails	Coyote Tan	410503CT-R or L	03	
Beretta 92/96/M9 (Not Elite, Brig. or M9A1)	Black	410504BK-R or L	04	
Beretta 92/96/M9 (Not Elite, Brig. or M9A1)	Coyote Tan	410504CT-R or L	04	
Beretta 92/96/M9 (Not Elite, Brig. or M9A1)	Foliage Green	410504FG-R or L	04	
Beretta 92/96/M9 (Not Elite, Brig. or M9A1)	Olive Drab	410504OD-R or L	04	
Sig 228/229/250DC with or without Rails	Black	410505BK-R	05	
Sig 220/225/226/228/229 with or without Rails	Black	410506BK-R or L	06	1095-01-560-2098 (L)
Sig 220/225/226/228/229 with or without Rails	Coyote Tan	410506CT-R or L	06	1095-01-560-6029 (R)
Springfield XD Compact and Service 4" Barrels	Black	410507BK-R or L	07	
Sig Pro 2022	Black	410508BK-R or L	08	
H&K USP Compact	Black	410509BK-R	09	
H&K P2000/USP Compact	Black	410509BK-L	09	
S&W 5900/4000 9/.40 Series Incl. TSW	Black	410510BK-R or L	10	
Ruger P85/89	Black	410511BK-R	11	
Ruger P95	Black	410512BK-R	12	
Glock 20/21/37, S&W M&P .45 and 9/.40 Pro	Black	410513BK-R or L	13	
H&K USP Full Size 9/.40	Black	410514BK-R or L	14	8465-01-555-1503 (R), 8465-01-554-1462 (L)
H&K P2000	Black	410516BK-R	16	
H&K P30	Black	410517BK-R or L	17	
FN 5.7 (USG Version)	Black	410518BK-R or L	18	
Taurus 24/7 OSS	Black	410519BK-R	19	
S&W J-Frame Revolvers 2" (Not .357)	Black	410520BK-R or L	20	
Walther P99	Black	410524BK-R or L	24	
S&W M&P 9/.40 and Sigma	Black	410525BK-R or L	25	
Beretta PX4 Storm	Black	410528BK-R	28	
Taurus 24/7	Black	410529BK-R	29	
Glock 29/30/39	Black	410530BK-R	30	
Springfield XD Sub-Compact	Black	410531BK-R or L	31	
Taurus 85 2" 5-Shot .38 (Some Models)	Black	410532BK-R	32	
Glock 38	Black	410538BK-R	38	
Taurus Judge (2.5" Cylinder)	Black	410540BK-R	40	
Ruger SR9	Black	410541BK-R	41	
Commander 1911 and Clones with or without Rails	Black	410542BK-R	42	
Caracal F	Black	410543BK-R or L	43	
Taurus Judge (3" Cylinder)	Black	410544BK-R or L	44	
SERPA® CQC® Concealment Holster – Carbon-Fiber Finish				
Model	Color	Part#	Size	NSN#
Glock 17/22/31	Black	410000BK-R or L	00	1095-01-523-5339
Glock 26/27/33	Black	410001BK-R or L	01	
Glock 19/23/32/36	Black	410002BK-R or L	02	1095-01-523-6017
Gov't 1911 and Clones with or without Rails	Black	410003BK-R or L	03	1095-01-525-2825
Beretta 92/96/M9 (Not Elite, Brig. or M9A1)	Black	410004BK-R or L	04	1095-01-525-2827
Sig 228/229/250DC with or without Rails	Black	410005BK-R	05	
Sig 220/225/226/228/229 with or without Rails	Black	410006BK-R or L	06	
Springfield XD Compact and Service 4" Barrels	Black	410007BK-R or L	07	
Sig Pro 2022	Black	410008BK-R or L	08	
H&K USP Compact	Black	410009BK-R	09	1095-01-525-2826
H&K P2000/USP Compact	Black	410009BK-L	09	
S&W 5900/4000 9/.40 Incl. TSW	Black	410010BK-R or L	10	
Ruger P85/89	Black	410011BK-R	11	
Ruger P95	Black	410012BK-R	12	
Glock 20/21/37, S&W M&P .45 and 9/.40 Pro	Black	410013BK-R or L	13	
H&K USP Full Size 9/.40	Black	410014BK-R or L	14	
H&K P2000	Black	410016BK-R	16	
H&K P30	Black	410017BK-R or L	17	
CONTINUED ON NEXT PAGE....				

SERPA® CQC® Concealment Holster – Carbon-Fiber Finish (continued)				
Model	Color	Part#	Size	NSN#
FN 5.7 (USG Version)	Black	410018BK-R or L	18	
Taurus 24/7 OSS	Black	410019BK-R	19	
Walther P99	Black	410024BK-R or L	24	
S&W M&P 9/40 and Sigma	Black	410025BK-R or L	25	
Beretta PX4 Storm	Black	410028BK-R	28	
Taurus 24/7	Black	410029BK-R	29	
Glock 23/30/39	Black	410030BK-R	30	
Springfield XD Sub-Compact	Black	410031BK-R or L	31	
Glock 38	Black	410038BK-R	38	
Ruger SR9	Black	410041BK-R	41	
Commander 1911 and Clones with or without Rails	Black	410042BK-R	42	
Caracal F	Black	410043BK-R or L	43	
SERPA® CQC® Light Bearing Concealment Holster				
Model	Color	Part#	Size	NSN#
Glock 17/22/31	Black	414500BK-R or L	00	
Gov't 1911 and Clones with or without Rails	Black	414503BK-R	03	
Sig 220/225/226/228/229 with or without Rails	Black	414506BK-R or L	06	
SERPA® CQC® Sportster® Holster				
Model	Color	Part#	Size	NSN#
Glock 17/22/31	Gunmetal Gray	413500BK-R or L	00	
Glock 26/27/33	Gunmetal Gray	413501BK-R or L	01	
Glock 19/23/32/36	Gunmetal Gray	413502BK-R or L	02	
Gov't 1911 and Clones with or without Rails	Gunmetal Gray	413503BK-R or L	03	
Beretta 92/96/M9 (Not Elite, Brig. or M9A1)	Gunmetal Gray	413504BK-R or L	04	
Sig 228/229/250 DC with or without Rails	Gunmetal Gray	413505BK-R	05	
Sig 220/225/226/228/229 with or without Rails	Gunmetal Gray	413506BK-R or L	06	
Springfield XD Compact and Service 4" Barrels	Gunmetal Gray	413507BK-R	07	
H&K USP Compact	Gunmetal Gray	413509BK-R	09	
H&K P2000 and USP Compact	Gunmetal Gray	413509BK-L	09	
S&W 5900/4000 9/40 Series Incl. TSW	Gunmetal Gray	413510BK-R or L	10	
Glock 20/21/37, S&W M&P .45 and 9/40 Pro	Gunmetal Gray	413513BK-R or L	13	
H&K USP Full Size 9/40	Gunmetal Gray	413514BK-R or L	14	
H&K P2000	Gunmetal Gray	413516BK-R	16	
FN 5.7 (USG Version)	Gunmetal Gray	413518BK-R or L	18	
S&W J-Frame Revolvers 2" (Not .357)	Gunmetal Gray	413520BK-R or L	20	
S&W M&P 9/40 and Sigma	Gunmetal Gray	413525BK-R or L	25	
SERPA® Level 2 Auto Lock™ Duty Holster				
Model	Color	Part#	Size	NSN#
Glock 17/19/22/23/31/32	Black	44H000BK-R	00	
Glock 17/19/20/21/22/23/31/32 and S&W M&P 9/40	Black	44H000BK-L	00	
Gov't 1911 and Clones with or without Rails	Black	44H003BK-R or L	03	
Beretta 92/96/M9 Standard or A1 with Rails (Not Elite or Brig.)	Black	44H004BK-R or L	04	
Sig 220/225/226/228/229 with or without Rails	Black	44H006BK-R or L	06	
Sig Pro 2022	Black	44H008BK-R or L	08	
Glock 20/21/21SF/37/38 and S&W M&P (All Models) with or without Rails	Black	44H013BK-R	13	
Glock 21SF with Larger 1913 Rails	Black	44H026BK-R	26	
SERPA® Level 3 Auto Lock™ Duty Holster – Matte Finish				
Model	Color	Part#	Size	NSN#
Glock 17/19/22/23/31/32	Black	44H100BK-R or L	00	
Gov't 1911 and Clones with or without Rails	Black	44H103BK-R or L	03	
Beretta 92/96/M9 Standard or A1 with Rails (Not Elite or Brig.)	Black	44H104BK-R or L	04	
Sig 220/225/226/228/229 with or without Rails	Black	44H106BK-R or L	06	
Springfield XD/XDM	Black	44H107BK-R or L	07	
Sig Pro 2022	Black	44H108BK-R or L	08	
H&K USP Compact/P2000 (Euro)	Black	44H109BK-R or L	09	
S&W 5946	Black	44H110BK-R or L	10	
Glock 20/21/21SF (Not 1913 Rail)/37/38	Black	44H113BK-R or L	13	
CONTINUED ON NEXT PAGE...				

SERPA® Level 3 Auto Lock™ Duty Holster – Matte Finish (continued)				
Model	Color	Part#	Size	NSN#
H&K Full Size USP 9/40	Black	44H114BK-R or L	14	
H&K F P2000 (US)	Black	44H116BK-R or L	16	
H&K P30	Black	44H117BK-R or L	17	
Walther P99	Black	44H124BK-R or L	24	
S&W M&P 9/40 with or without Thumb Safety	Black	44H125BK-R or L	25	
Sig 250 DC	Black	44H127BK-R or L	27	
S&W M&P .45 and 9/40 Pro with or without Thumb Safety	Black	44H145BK-R or L	45	

SERPA® Level 3 Auto Lock™ Duty Holster – Plain Finish				
Model	Color	Part#	Size	NSN#
Glock 17/19/22/23/31/32	Black	44H100PL-R or L	00	
Gov't 1911 and Clones with or without Rails	Black	44H103PL-R or L	03	
Beretta 92/96/M9 Standard or A1 with Rails (Not Elite or Brig.)	Black	44H104PL-R or L	04	
Sig 220/225/226/228/229 with or without Rails	Black	44H106PL-R or L	06	
Springfield XD/XDM (Not Tactical or Comp Series)	Black	44H107PL-R or L	07	
H&K USP Compact/P2000 (Euro)	Black	44H109PL-R or L	09	
S&W 5946	Black	44H110PL-R or L	10	
Glock 20/21/21SF (Not 1913 Rail)/37/38	Black	44H113PL-R or L	13	
H&K USP Full Size 9/40	Black	44H114PL-R or L	14	
H&K P2000 (US)	Black	44H116PL-R or L	16	
H&K P30	Black	44H117PL-R or L	17	
S&W M&P 9/40 with or without Thumb Safety	Black	44H125PL-R or L	25	
Sig 250 DC	Black	44H127PL-R or L	27	
S&W M&P .45 and 9/40 Pro with or without Thumb Safety	Black	44H145PL-R or L	45	

SERPA® Level 3 Auto Lock™ Duty Holster – Basketweave Finish				
Model	Color	Part#	Size	NSN#
Glock 17/19/22/23/31/32	Black	44H100BW-R or L	00	
Gov't 1911 and Clones with or without Rails	Black	44H103BW-R or L	03	
Beretta 92/96/M9 Standard or A1 with Rails (Not Elite or Brig.)	Black	44H104BW-R or L	04	
Sig 220/225/226/228/229 with or without Rails	Black	44H106BW-R or L	06	
Springfield XD/XDM	Black	44H107BW-R or L	07	
H&K USP Compact/P2000 (Euro)	Black	44H109BW-R or L	09	
S&W 5946	Black	44H110BW-R or L	10	
Glock 20/21/21SF (Not 1913 Rail)/37/38	Black	44H113BW-R or L	13	
H&K P2000 (US)	Black	44H116BW-R or L	16	
H&K USP Full Size 9/40	Black	44H114BW-R or L	14	
H&K P30	Black	44H117BW-R or L	17	
S&W M&P 9/40 with or without Thumb Safety	Black	44H125BW-R or L	25	
Sig 250 DC	Black	44H127BW-R or L	27	
S&W M&P .45 and 9/40 Pro with or without Thumb Safety	Black	44H145BW-R or L	45	

SERPA® Level 3 Light Bearing Auto Lock™ Duty Holster – Matte Finish				
Model	Color	Part#	Size	NSN#
Glock 17/19/22/23/31/32	Black	44H500BK-R or L	00	
Gov't 1911 and Clones with or without Rails	Black	44H503BK-R or L	03	
Beretta 92/96/M9 Standard or A1 with Rails (Not Elite or Brig.)	Black	44H504BK-R or L	04	
Sig 228/229	Black	44H505BK-R or L	05	
Sig 220/225/226	Black	44H506BK-R or L	06	
Glock 20/21/21SF	Black	44H513BK-R or L	13	
H&K P2000 (US)	Black	44H516BK-R or L	16	
S&W M&P 9/40 with or without Thumb Safety	Black	44H525BK-R or L	25	
S&W M&P .45 and 9/40 Pro with or without Thumb Safety	Black	44H545BK-R or L	45	

SERPA® Level 3 Light Bearing Auto Lock™ Duty Holster – Plain Finish				
Model	Color	Part#	Size	NSN#
Glock 17/19/22/23/31/32	Black	44H500PL-R or L	00	
Gov't 1911 and Clones with or without Rails	Black	44H503PL-R or L	03	
Beretta 92/96/M9 Standard or A1 with Rails (Not Elite or Brig.)	Black	44H504PL-R or L	04	
CONTINUED ON NEXT PAGE...				

SERPA® Level 3 Light Bearing Auto Lock™ Duty Holster – Plain Finish (continued)				
Model	Color	Part#	Size	NSN#
Sig 228/229	Black	44H505PL-R or L	05	
Sig 220/225/226	Black	44H506PL-R or L	06	
Glock 20/21/21SF	Black	44H513PL-R or L	13	
H&K P2000 (US)	Black	44H516PL-R or L	16	
S&W M&P 9/40 with or without Thumb Safety	Black	44H525PL-R or L	25	
S&W M&P .45 and 9/40 Pro with or without Thumb Safety	Black	44H545PL-R or L	45	
SERPA® Level 3 Light Bearing Auto Lock™ Duty Holster – Basketweave Finish				
Model	Color	Part#	Size	NSN#
Glock 17/19/22/23/31/32	Black	44H500BW-R or L	00	
Gov't 1911 and Clones with or without Rails	Black	44H503BW-R or L	03	
Beretta 92/96/M9 Standard or A1 with Rails (Not Elite or Brig.)	Black	44H504BW-R or L	04	
Sig 228/229	Black	44H505BW-R or L	05	
Sig 220/225/226	Black	44H506BW-R or L	06	
Glock 20/21/21SF	Black	44H513BW-R or L	13	
H&K P2000 (US)	Black	44H516BW-R	16	
S&W M&P 9/40 with or without Thumb Safety	Black	44H525BW-R or L	25	
S&W M&P .45 and 9/40 Pro with or without Thumb Safety	Black	44H545BW-R or L	45	
Epoch™ Level 3 Light Bearing Duty Holster – Matte Finish				
Model	Color	Part#	Size	NSN#
Glock 17/22/31	Black	44E000BK-R or L	00	
Glock 20/21/37	Black	44E013BK-R or L	13	
S&W M&P 40	Black	44E025BK-R or L	25	
Epoch™ Level 3 Light Bearing Duty Holster – Basketweave Finish				
Model	Color	Part#	Size	NSN#
Glock 17/22/31	Black	44E000BW-R or L	00	
Glock 20/21/37	Black	44E013BW-R or L	13	
S&W M&P 40	Black	44E025BW-R or L	25	
Epoch™ Level 3 Light Bearing Duty Holster – Plain Finish				
Model	Color	Part#	Size	NSN#
Glock 17/22/31	Black	44E000PL-R or L	00	
Glock 20/21/37	Black	44E013PL-R or L	13	
S&W M&P 40	Black	44E025PL-R or L	25	
SERPA® Level 2 Tactical Holster				
Model	Color	Part#	Size	NSN#
Glock 17/19/22/23/31/32	Black	430500BK-R	00	1095-01-533-3013
Glock 17/19/20/21/22/31/32 and S&W M&P 9/40/.45	Black	430500BK-L	00	
Gov't 1911 and Clones with or without Rails	Black	430503BK-R or L	03	
Gov't 1911 and Clones with or without Rails	Coyote Tan	430503CT-R or L	03	
Gov't 1911 and Clones with or without Rails	Olive Drab	430503OD-R or L	03	
Beretta 92/96/M9 Standard or A1 with Rails (Not Elite or Brig.)	Black	430504BK-R or L	04	1095-01-533-3010
Beretta 92/96/M9 Standard or A1 with Rails (Not Elite or Brig.)	Coyote Tan	430504CT-R or L	04	1095-01-533-3009
Beretta 92/96/M9 Standard or A1 with Rails with USMC Medallion (Not Elite or Brig.)	Coyote Tan	430504CT-R or L-USMC	04	
Beretta 92/96/M9 Standard or A1 with Rails (Not Elite or Brig.)	Foliage Green	430504FG-R or L	04	
Beretta 92/96/M9 Standard or A1 with Rails with US Medallion (Not Elite or Brig.)	Foliage Green	430504FG-R or L-Army	04	
Beretta 92/96/M9 Standard or A1 with Rails (Not Elite or Brig.)	Olive Drab	430504OD-R or L	04	
Sig 220/225/226/228/229 with or without Rails	Black	430506BK-R or L	06	
Sig 220/225/226/228/229 with or without Rails	Coyote Tan	430506CT-R or L	06	
Sig 220/225/226/228/229 with or without Rails	Olive Drab	430506OD-R or L	06	
Sig Pro 2022	Black	430508BK-R or L	08	
Glock 20/21/21SF/37/38 and S&W M&P (All Models) with or without Rails	Black	430513BK-R	13	
Glock 21SF with Larger 1913 Rails	Black	430526BK-R	26	
SERPA® Level 3 Tactical Holster				
Model	Color	Part#	Size	NSN#
Glock 17/19/22/23/31/32	Black	430600BK-R or L	00	1095-01-533-3013
Gov't 1911 and Clones with or without Rails	Black	430603BK-R or L	03	
Beretta 92/96/M9 Standard or A1 with Rails (Not Elite or Brig.)	Black	430604BK-R or L	04	
Beretta 92/96/M9 Standard or A1 with Rails (Not Elite or Brig.)	Black	430604FG-R or L	04	
CONTINUED ON NEXT PAGE...				

SERPA® Level 3 Tactical Holster (continued)

Model	Color	Part#	Size	NSN#
Sig 220/225/226/228/229 with or without Rails	Black	430606BK-R or L	06	
Springfield XD/XDM (Not Tactical or Comp Series)	Black	430607BK-R or L	07	1095-01-533-3010
Sig Pro 2022	Black	430608BK-R or L	08	1095-01-533-3009
H&K USP Compact/P2000 (Euro)	Black	430609BK-R or L	09	
S&W 5946	Black	430610BK-R or L	10	
Glock 20/21/21SF (Not 1913 Rail)/37/38	Black	430613BK-R or L	13	
H&K USP Full Size 9/40	Black	430614BK-R or L	14	
H&K P2000 (US)	Black	430616BK-R or L	16	
H&K P30	Black	430617BK-R or L	17	
Walther P99	Black	430624BK-R or L	24	
S&W M&P 9/40 with or without Thumb Safety	Black	430625BK-R or L	25	
Sig 250 DC	Black	430627BK-R or L	27	
S&W M&P .45 and 9/40 Pro with or without Thumb Safety	Black	430645BK-R or L	45	

SERPA® Level 3 Light Bearing Tactical Holster

Model	Color	Part#	Size	NSN#
Glock 17/19/22/23/31/32	Black	430700BK-R or L	00	
Gov't 1911 and Clones with or without Rails	Black	430703BK-R or L	03	
Beretta 92/96/M9 Standard or A1 with Rails (Not For Brig. or Elite)	Black	430704BK-R or L	04	
Beretta 92/96/M9 Standard or A1 with Rails (Not For Brig. or Elite)	Foliage Green	430704FG-R or L	04	
Sig 228/229	Black	430705BK-R or L	05	
Sig 220/225/226	Black	430706BK-R or L	06	
Glock 20/21/21SF	Black	430713BK-R or L	13	
H&K P2000 (US)	Black	430716BK-R or L	16	
S&W M&P 9/40 with or without Thumb Safety	Black	430725BK-R or L	25	
S&W M&P .45 and 9/40 Pro with or without Thumb Safety	Black	430745BK-R or L	45	

GripBreak™ Leather Holster

Model	Color	Part#	Size	NSN#
Colt 1911 and Clones	Black	421901BK-R or L	01	
Glock 17/19/22/23/31/32	Black	421903BK-R or L	03	
S&W M&P 9/40	Black	421928BK-R or L	28	

Suede Leather Tuckable Holster

Model	Color	Part#	Size	NSN#
2" 5-Shot Revolvers	Brown	421601BN-R or L	01	
Officer's 1911	Brown	421602BN-R or L	02	
Glock 26/27	Brown	421603BN-R or L	03	
Glock 19/23/32/36	Brown	421604BN-R or L	04	
Ruger LCP, Kel-Tec P3AT, Kahr .380 and other Small .380s	Brown	421605BN-R or L	05	
Kahr CW9/CW40/P9/P40/K9/K40	Brown	421606BN-R or L	06	
Commander 1911	Brown	421607BN-R	07	
Gov't 1911	Brown	421608BN-R or L	08	
S&W M&P Full Size 9/40	Brown	421609BN-R or L	09	
Glock 30, S&W M&P Compact and other Wide Frame Compact Autos	Brown	421610BN-R or L	10	
Glock 21, S&W M&P .45, FNP 9/40 and other Full Size Extra Large-Frame Autos	Brown	421611BN-R or L	11	

Suede Leather Angle Adjustable ISP Holster

Model	Color	Part#	Size	NSN#
2" 5-Shot .38/.357 Revolvers	Brown	421801BN-R or L	01	
Officer's 1911 and Clones	Brown	421802BN-R or L	02	
Glock 26, Ruger LC9 and other Sub-Compact 9/40	Brown	421803BN-R or L	03	
Glock 19, Springfield XD Compact and other Compact 9/40	Brown	421804BN-R or L	04	
Ruger LCP, Kel-Tec P3AT, Kahr .380 and other Small .380s	Brown	421805BN-R or L	05	
Kahr PM9, Kel-Tec P9 and other Sub-Compact Slim Frame 9/40	Brown	421806BN-R or L	06	
Gov't 1911 and Clones with or without Rails	Brown	421807BN-R or L	07	
Gov't 1911, Clones and Browning Hi-Power	Brown	421808BN-R or L	08	
Glock 17, Ruger SR9, Springfield XD and other Full Size Large-Frame 9/40	Brown	421809BN-R or L	09	
Glock 30, S&W M&P Compact and other Wide Frame Compact Autos	Brown	421810BN-R or L	010	
Glock 21, S&W M&P .45, FNP 9/40 and other Full Size Extra Large-Frame Autos	Brown	421811BN-R or L	011	

Leather Kydex® Tuckable Pancake Holster Combo				
Model	Color	Part#	Size	NSN#
Glock 9/40/.357	Black	422000BK-R or L	00	
Glock 45 and S&W M&P	Black	422001BK-R or L	01	
Colt 1911	Black	422002BK-R or L	02	
S&W J-Frame and Taurus 85	Black	422003BK-R or L	03	
Ruger SP101 and LCR	Black	422004BK-R or L	04	
Springfield XD/XDM	Black	422005BK-R or L	05	
Kahr 9/40	Black	422006BK-R or L	06	
Ruger LC9	Black	422007BK-R or L	07	
Ruger LCP	Black	422008BK-R or L	08	
S&W M&P Shield	Black	422009BK-R or L	09	

Leather 3-Slot Pancake Holster				
Model	Color	Part#	Size	NSN#
Beretta 92/96 Black	Black	420000BK-R or L	00	
Gov't 1911 (5" Barrel)	Black	420001BK-R or L	01	
Gov't 1911 (5" Barrel)	Brown	420001BN-R or L	01	
Commander 1911 (4" Barrel)	Black	420002BK-R or L	02	
Glock 17/22/31	Black	420003BK-R or L	03	
Glock 17/22/31	Brown	420003BN-R or L	03	
Glock 19/23/32/36	Black	420004BK-R or L	04	
Glock 19/23/32/36	Brown	420004BN-R or L	04	
Glock 26/27/33	Black	420005BK-R or L	05	
Glock 26/27/33	Brown	420005BN-R or L	05	
Glock 20/21/37	Black	420006BK-R or L	06	
H&K P2000/USP Compact	Black	420007BK-R or L	07	
S&W J-Frame and Taurus 85	Black	420009BK-R or L	09	
S&W Most 5900/4000/900 WHILE SUPPLIES LAST	Black	420011BK-R or L	11	
Sig Pro 2009/2340/2022	Black	420012BK-R or L	12	
Sig 228/229/225	Black	420013BK-R or L	13	
Sig 220/226	Black	420014BK-R or L	14	
Sig 220/226	Brown	420014BN-R or L	14	
Springfield XD (4" Barrel)	Black	420015BK-R or L	15	
Springfield XD (4" Barrel)	Brown	420015BN-R or L	15	
Springfield XD Compact	Black	420016BK-R or L	16	
Springfield XD Compact	Brown	420016BN-R or L	16	
S&W M&P 9/40 (4" Barrel)	Black	420018BK-R or L	18	
S&W M&P 9/40 (4" Barrel)	Brown	420018BN-R or L	18	
S&W M&P 9/40 Compact	Black	420019BK-R or L	19	
S&W M&P 9/40 Compact	Brown	420019BN-R or L	19	
S&W M&P45 and 9/40 Pro	Black	420020BK-R or L	20	
Springfield XDM	Black	420021BK-R or L	21	
Springfield XDM	Brown	420021BN-R or L	21	
Beretta PX4 Storm	Black	420022BK-R or L	22	
Kahr CW9/CW40/P9/P40/K9/K40	Black	420023BK-R or L	23	

Leather Detachable Slide Holster				
Model	Color	Part#	Size	NSN#
Gov't 1911 and Commander 1911	Black	420101BK-R or L	01	
Glock 9/40/.357	Black	420102BK-R or L	02	
Glock 20/21/37	Black	420103BK-R or L	03	
H&K P2000/USP Compact	Black	420104BK-R or L	04	
Sig Pro 2009/2340/2022	Black	420106BK-R	06	
Sig Pro 2009/2340/2022 WHILE SUPPLIES LAST	Black	420106BK-L	06	
Sig 220/225/226	Black	420107BK-R or L	07	
Springfield XD/XD Compact	Black	420108BK-R or L	08	
Walther P99 WHILE SUPPLIES LAST	Black	420109BK-R or L	09	
Beretta PX4 Storm	Black	420122BK-R or L	22	
Kahr CW9/CW40/P9/P40/K9/K40	Black	420123BK-R or L	23	
S&W M&P (All Models)	Black	420128BK-R or L	28	

Leather Inside-the-Pants Holster with Clip

Model	Color	Part#	Size	NSN#
Gov't 1911 (5" Barrel)	Brown	421401BN-R or L	01	
Commander 1911 (4" Barrel)	Brown	421402BN-R or L	02	
Glock 17/19/22/23/31/32/36	Brown	421403BN-R or L	03	
Glock 26/27/33	Brown	421404BN-R or L	04	
2" S&W J-Frame, Taurus 85 and Ruger SP101	Brown	421406BN-R or L	06	
Springfield XD/XDM	Brown	421411BN-R or L	11	
Springfield XD Sub-Compact	Brown	421412BN-R or L	12	
Kahr CW9/CW40/P9/P40/K9/K40	Brown	421423BN-R or L	23	

Leather Slide Holster with Thumb Break

Model	Color	Part#	Size	NSN#
Gov't 1911 and Commander 1911	Brown	421101BN-R or L	01	
Glock 9/.40/.357/Model 36	Brown	421102BN-R or L	02	
Glock 20/21/29/30/37/38/39	Brown	421103BN-R or L	03	
Sig 220/225/226	Brown	421107BN-R or L	07	
Springfield XDM/XD/XD Sub-Compact	Brown	421108BN-R or L	08	
S&W M&P (All Models)	Brown	421128BN-R or L	28	

Leather Multi-Position Holster

Model	Color	Part#	Size	NSN#
Gov't 1911 (5" Barrel)	Brown	421201BN-R or L	01	
S&W K/L-Frame, Ruger GP-100 and Colt King Cobra and Python (4" Barrel)	Brown	421202BN-R or L	02	
S&W N-Frame Full Lug and Ruger Redhawk (4" Barrel)	Brown	421203BN-R or L	03	
S&W N-Frame Full Lug (6" Barrel)	Brown	421204BN-R or L	04	
Ruger Super Redhawk (7.5" Barrel)	Brown	421207BN-R or L	07	

Leather Yaqui Slide Holster

Model	Color	Part#	Size	NSN#
Glock 9/.40/.357/Model 36	Brown	421501BN-R or L	01	
Glock 20/21/29/30/37/38/39	Brown	421502BN-R or L	02	
1911 (All Lengths and Clones)	Brown	421503BN-R or L	03	
Springfield XD/XDM (All Lengths)	Brown	421504BN-R or L	04	
Sig 220/225/226/228/229	Brown	421505BN-R or L	05	

Leather Hip Scabbard Holster

Model	Color	Part#	Size	NSN#
S&W K/L-Frame, Ruger GP-100 and Colt King Cobra and Python (4" Barrel)	Brown	421702BN-R or L	02	
S&W N-Frame Full Lug and Ruger Redhawk (4" Barrel)	Brown	421703BN-R or L	03	

Leather Cutaway Holster

Model	Color	Part#	Size	NSN#
Glock 17/22/31	Brown	421301BN-R or L	01	
Glock 19/23/32/36	Brown	421302BN-R or L	02	
Glock 26/27/33	Brown	421303BN-R or L	03	
Gov't 1911	Brown	421304BN-R or L	04	
Commander 1911	Brown	421305BN-R or L	05	
Officer's 1911	Brown	421306BN-R or L	06	
Springfield XD 4"/XDM	Brown	421307BN-R or L	07	

Leather Compact Slide Holster with Mag Pouch

Model	Color	Part#	Size	NSN#
Gov't, Commander and Officer's 1911	Black	420201BK-R or L	01	
Glock 17/19/22/23/31/32/36	Black	420202BK-R or L	02	
Glock 26/27/33	Black	420203BK-R or L	03	
Springfield XD/XD Sub-Compact (4" Barrel)	Black	420208BK-R or L	08	
Walther P99	Black	420209BK-R	09	
Walther P99 WHILE SUPPLIES LAST	Black	420209BK-L	09	
Beretta PX4 Storm	Black	420222BK-R or L	22	
Kahr CW9/CW40/P9/P40/K9/K40	Black	420223BK-R or L	23	
S&W M&P 9/.40/.357 and Sig (All Models)	Black	420228BK-R or L	28	

Leather Check-Six™ Holster				
Model	Color	Part#	Size	NSN#
Gov't 1911 (5" Barrel)	Black	420701BK-R or L	01	
Commander 1911 (4" Barrel)	Black	420702BK-R or L	02	
Glock 17/19/22/23	Black	420703BK-R or L	03	
Glock 26/27/33	Black	420704BK-R or L	04	
S&W J-Frame and Taurus 85	Black	420705BK-R or L	05	
Sig Pro 2009/2340/2022 WHILE SUPPLIES LAST	Black	420706BK-L	06	
Sig 228/229/225	Black	420707BK-R or L	07	
Springfield XD Sub-Compact	Black	420708BK-R or L	08	
Walther P99 WHILE SUPPLIES LAST	Black	420709BK-R or L	09	
S&W M&P 9/.40 (4" Barrel)	Black	420718BK-R or L	18	
S&W M&P 9/.40 Compact	Black	420719BK-R or L	19	
S&W M&P .45 and Pro 9/.40	Black	420720BK-R or L	20	
Springfield XDM	Black	420721BK-R or L	21	
Beretta PX4 Storm	Black	420722BK-R or L	22	
Kahr CW9/CW40/P9/P40/K9/K40	Black	420723BK-R or L	23	

Leather Speed Classic				
Model	Color	Part#	Size	NSN#
S&W J-Frame, Taurus 85 and Ruger SP101	Black	420800BK-R or L	00	
S&W J-Frame, Taurus 85 and Ruger SP101	Brown	420800BN-R or L	00	

Leather Inside-the-Pants Holster				
Model	Color	Part#	Size	NSN#
Beretta 92/96	Black	420400BK-R or L	00	
Gov't 1911 (5" Barrel)	Black	420401BK-R or L	01	
Commander 1911 (4" Barrel)	Black	420402BK-R or L	02	
Glock 17/19/22/23/31/32/36	Black	420403BK-R or L	03	
Glock 26/27/33	Black	420404BK-R or L	04	
H&K P2000/USP Compact	Black	420405BK-R or L	05	
S&W J-Frame, Taurus 85 and Ruger SP101	Black	420406BK-R or L	06	
Sig Pro 2009/2340/2022 WHILE SUPPLIES LAST	Black	420408BK-L	08	
Sig 228/229/225	Black	420409BK-R or L	09	
Sig 220/226	Black	420410BK-R or L	10	
Springfield XD (4" Barrel)	Black	420411BK-R or L	11	
Springfield XD Sub-Compact	Black	420412BK-R or L	12	
S&W M&P 9/.40 (4" Barrel)	Black	420418BK-R or L	18	
S&W M&P 9/.40 Compact	Black	420419BK-R or L	19	
S&W M&P .45 and 9/.40 Pro	Black	420420BK-R or L	20	
Springfield XDM	Black	420421BK-R or L	21	
Beretta PX4 Storm	Black	420422BK-R or L	22	
Kahr CW9/CW40/P9/P40/K9/K40	Black	420423BK-R or L	23	

Leather Compact Askins				
Model	Color	Part#	Size	NSN#
Gov't 1911 and Commander 1911	Black	420501BK-R or L	01	
Gov't 1911 and Commander 1911	Brown	420501BN-R or L	01	
Glock 9/.40/357/Model 36	Black	420502BK-R or L	02	
Glock 9/.40/357/Model 36	Brown	420502BN-R or L	02	
Glock 20/21/29/30/37/38/39	Black	420503BK-R or L	03	
Glock 20/21/29/30/37/38/39	Brown	420503BN-R or L	03	
H&K P2000/USP Compact	Black	420504BK-R or L	04	
S&W J-Frame, Taurus 85 and Ruger SP101	Black	420506BK-R or L	06	
S&W K/L-Frame (4" Barrel)	Black	420507BK-R	07	
Sig 220/225/226	Black	420510BK-R or L	10	
Springfield XD/XD Sub-Compact/XDM	Black	420511BK-R or L	11	
Springfield XD/XD Sub-Compact/XDM	Brown	420511BN-R or L	11	
Beretta PX4 Storm	Black	420522BK-R or L	22	
Kahr CW9/CW40/P9/P40/K9/K40	Black	420523BK-R or L	23	
S&W M&P (All Models)	Black	420528BK-R or L	28	
S&W M&P (All Models)	Brown	420528BN-R or L	28	

GripBreak™ Nylon Holster				
Model	Color	Part#	Size	NSN#
Colt 1911 and Clones	Black	40GB01BK-R or L	01	
Glock 17/19/22/23/31/32	Black	40GB03BK-R or L	03	
S&W M&P 9/.40	Black	40GB28BK-R or L	28	

Nylon S&W X-Frame Hip Holster				
Model	Color	Part#	Size	NSN#
S&W 500/460 (4" – 5" Barrel)	Black	40XF53BK-R or L	53	
S&W 500/460 (8" – 8.75" Barrel)	Black	40XF54BK-R or L	54	

Nylon Askins Style Hip Holster				
Model	Color	Part#	Size	NSN#
3" – 4" Barrel Medium-Frame .32/.380 Autos	Black	40NA01BK	01	
4.5" – 5" Barrel Large-Frame Autos	Black	40NA03BK	03	
Glock 26/27/33 and Other Sub-Compact 9/.40 Autos	Black	40NA04BK	04	
3.75" – 4.5" Barrel Large Autos	Black	40NA05BK	05	
3.25" – 3.75" Barrel Medium/Large Autos	Black	40NA06BK	06	
Colt Gov't Large Autos, Browning Hi-Power and Variants	Black	40NA07BK	07	

Nylon Scoped Pistol Bandolier Holster				
Model	Color	Part#	Size	NSN#
Scoped 5" – 6.5" Barrel Medium/Large Double-Action Revolvers and 4.625" – 5.25" Barrel Single-Action Revolvers	Black	40SB03BK-R	03	
Scope 6" – 8.5" Barrel Medium/Large Double-Action Revolver, 6" – 8.5" Barrel Single-Action Revolvers and 10" Barrel T/C Contender	Black	40SB04BK-R	04	
Scoped 14" – 16" Barrel T/C Super Contender, Encore, 9.5" – 10.75" Barrel Single/Double-Action Revolver, Savage Striker and Ruger Charger	Black	40SB13BK-R	13	

Nylon Vertical Shoulder Holster without Scope				
Model	Color	Part#	Size	NSN#
2" – 3" Barrel Small/Medium Double-Action Revolvers (Except 2" 5-Shot)	Black	40VH00BK-R or L	00	
3" – 4" Barrel Medium Autos and 3.25" – 3.75" Barrel Large Autos (.32/.380)	Black	40VH01BK-R or L	01	
4" Barrel Medium/Large Double-Action Revolvers	Black	40VH02BK-R or L	02	
5" – 6.5" Barrel Medium/Large Double-Action Revolvers and 4.625" – 5.25" Barrel Single-Action Revolvers	Black	40VH03BK-R or L	03	
7" – 8.5" Barrel Medium/Large Double-Action Revolvers and 6" – 7.5" Barrel Single-Action Revolvers	Black	40VH04BK-R or L	04	
4.5" – 5" Barrel Large Autos, Open End (Safety Strap Rotates to Secure Autos on Grip or Hammer)	Black	40VH05BK-R or L	05	
5.5" – 6" Barrel .22 Autos and Airguns	Black	40VH06BK-R or L	06	
9.5" – 10.75" Barrel Single- and Double-Action Revolvers	Black	40VH11BK-R or L	11	
10" Barrel T/C Contenders	Black	40VH12BK-R or L	12	
14" and 16" Barrel T/C Super Contenders, Encore and 10" Barrel Remington XP-100	Black	40VH13BK-R or L	13	
3.75" – 4.5" Barrel Large Autos	Black	40VH15BK-R or L	15	

Nylon Vertical Shoulder Holster with Scope				
Model	Color	Part#	Size	NSN#
5" – 6.5" Barrel Medium/Large Double-Action and 4.625" – 5.25" Barrel Single-Action Revolvers	Black	40SV03BK-R or L	03	
6" – 8.5" Barrel Medium/Large Double-Action and 6" – 8.5" Barrel Single-Action Revolvers and 10" Barrel T/C Contenders	Black	40SV04BK-R or L	04	
14" and 16" Barrel T/C Super Contenders, Encore and 10V Barrel Remington XP-100, and 9.5" – 10.75" Barrel Single & Double-Action Revolvers	Black	40SV13BK-R or L	13	

Nylon Horizontal Shoulder Holster				
Model	Color	Part#	Size	NSN#
2" – 3" Barrel Small/Medium Double-Action Revolvers (Except 2" 5-Shot)	Black	40HS00BK-MD or LG	00	
3" – 4" Barrel Medium-Frame .32/.380 Autos	Black	40HS01BK-MD or LG	01	
4" Barrel and Intermediate Double-Action Revolvers	Black	40HS02BK-MD or LG	02	
4.5" – 5" Barrel Large Autos	Black	40HS05BK-MD or LG	05	
3.75" – 4.5" Barrel Large Autos	Black	40HS15BK-MD or LG	15	
3.25" – 3.75" Barrel Medium/Large Autos	Black	40HS16BK-MD or LG	16	
2" Barrel Small-Frame 5-Shot Revolvers with Hammer Spur	Black	40HS36BK-MD or LG	36	

Nylon Compact Belt Slide Holster				
Model	Color	Part#	Size	NSN#
Most Autos and Revolvers	Black	40CS00BK	00	
Small Autos (.22/.25) and Very Small-Frame .32 and .380s	Black	40CS01BK	01	

Nylon Hip Holster with Thumb Break				
Model	Color	Part#	Size	NSN#
2" – 3" Barrel Small/Medium Double-Action Revolvers (Except 2" 5-Shot)	Black	40HT00BK-R or L	00	
3" – 4" Barrel Medium-Frame .32/.380 Autos	Black	40HT01BK-R or L	01	
4" Barrel Medium and Intermediate Double-Action Revolvers	Black	40HT02BK-R or L	02	
6" Barrel Medium and Intermediate Double-Action Revolvers	Black	40HT03BK-R or L	03	
4.5" – 5" Barrel Large Autos	Black	40HT05BK-R or L	05	
3.75" – 4.5" Barrel Large Autos	Black	40HT15BK-R or L	15	
3.25" – 3.75" Barrel Medium/Large Autos	Black	40HT16BK-R or L	16	
Colt Gov't Large Autos and Browning Hi-Power	Black	40HT19BK-R or L	19	
Glock 17/19/20/21/22/23/29/36	Black	40HT21BK-R or L	21	
2" Barrel Small-Frame 5-Shot Revolvers with Hammer Spur	Black	40HT36BK-R or L	36	

Nylon Paddle Holster				
Model	Color	Part#	Size	NSN#
2" – 3" Barrel Small/Medium Double-Action Revolvers (Except 2" 5-Shot)	Black	40PH00BK-R	00	
3" – 4" Barrel Medium-Frame .32/.380 Autos	Black	40PH01BK-R	01	
4" Barrel and Intermediate Double-Action Revolvers	Black	40PH02BK-R	02	
4.5" – 5" Barrel Large Autos	Black	40PH05BK-R	05	
3.75" – 4.5" Barrel Large Autos	Black	40PH15BK-R	15	
3.25" – 3.75" Barrel Medium/Large Autos	Black	40PH16BK-R	16	
Colt Gov't Large Autos and Browning Hi-Power	Black	40PH19BK-R	19	
Glock 17/19/20/21/22/23/29/30	Black	40PH21BK-R	21	
2" Barrel Small-Frame 5-Shot Revolvers with Hammer Spur	Black	40PH36BK-R	36	

Nylon 3-Slot Pancake Holster				
Model	Color	Part#	Size	NSN#
2" – 3" Barrel Small/Medium Double-Action Revolvers (Except 2" 5-Shot)	Black	40PC00BK	00	
3" – 4" Barrel Medium-Frame .32/.380 Autos	Black	40PC01BK	01	
4" Barrel Medium and Intermediate Double-Action Revolvers	Black	40PC02BK	02	
4.5" – 5" Barrel Large Autos	Black	40PC03BK	03	
Glock 26/27/33 and other Sub-Compact 9/40	Black	40PC04BK	04	
3.75" – 4.5" Barrel Large Autos	Black	40PC05BK	05	
3.25" – 3.75" Barrel Medium/Large Autos	Black	40PC06BK	06	
Colt Gov't Large Autos and Browning Hi-Power	Black	40PC07BK	07	
H&K USP 9/40/45 and USP Compact	Black	40PC30BK	30	
2" Barrel Small-Frame 5-Shot Revolvers with Hammer Spur	Black	40PC36BK	36	

Nylon Laser Holster				
Model	Color	Part#	Size	NSN#
3" – 4" BBL Medium Autos with Most Under-BBL Lasers	Black	40LH01BK	01	
3.25" – 3.75" BBL Medium/Large-Frame Autos with Most Under-BBL Lasers	Black	40LH02BK	02	
Gov't 1911 with Most Under-BBL Lasers	Black	40LH03BK	03	

Nylon Hip Holster				
Model	Color	Part#	Size	NSN#
2" – 3" Barrel Small/Medium Double-Action Revolvers (Except 2" 5-Shot)	Black	73NH00BK-R or L	00	
3" – 4" Barrel Medium Frame .32/.380 Autos	Black	73NH01BK-R or L	01	
3" – 4" Barrel Medium/Large Double-Action Revolvers	Black	73NH02BK-R or L	02	
5" – 6.5" Barrel Medium/Large Double-Action Revolvers	Black	73NH03BK-R or L	03	
4.5" – 5" Barrel Large Autos, Open End	Black	73NH04BK-R or L	04	
Small Autos (.22/.25) and Very Small-Frame .32 and .380s	Black	73NH05BK-R or L	05	
Glock 26/27/33 and other Sub-Compact 9/40	Black	73NH06BK-R or L	06	
3.5" – 4.5" Barrel Large Autos, Open End	Black	73NH07BK-R or L	07	
3.25" – 3.75" Barrel Medium/Large Autos	Black	73NH08BK-R or L	08	
2" Small-Frame 5-Shot Revolvers with Hammer Spur	Black	73NH09BK-R or L	09	
7" – 8.5" Barrel Medium/Large Double-Action Revolvers (Tie-Down Loop Included)	Black	73NH10BK-R or L	10	
9.5" – 10.75" Barrel Single- and Double-Action Revolvers (Tie-Down Loop Included)	Black	73NH11BK-R or L	11	
3" – 5" Barrel Single-Action Revolvers	Black	73NH12BK-R or L	12	
5.5" – 6.5" Barrel Single-Action Revolvers	Black	73NH13BK-R or L	13	

CONTINUED ON NEXT PAGE...

Nylon Hip Holster (continued)

Model	Color	Part#	Size	NSN#
10.5" Barrel .22 Autos (Tie-Down Loop Included)	Black	73NH17BK-R or L	17	
6" Raging Bull and 6" S&W N-Frame Full Lug	Black	73NH18BK-R or L	18	
8" Raging Bull and 8.375" S&W N-Frame Full Lug	Black	73NH19BK-R or L	19	

Nylon Inside-the-Pants Holster with Retention Strap

Model	Color	Part#	Size	NSN#
2" – 3" Barrel Small/Medium Double-Action Revolvers (Except 2" 5-Shot)	Black	73IR00BK-R or L	00	
3" – 4" Barrel Medium-Frame .32/.380 Autos	Black	73IR01BK-R or L	01	
4" Barrel Medium and Intermediate Double-Action Revolvers	Black	73IR02BK-R or L	02	
4.5" – 5" Barrel Large Autos	Black	73IR03BK-R or L	03	
Small Autos (.22/.25) and Very Small-Frame .32 and .380s	Black	73IR04BK-R or L	04	
3.75" – 4.5" Barrel Large Autos	Black	73IR06BK-R or L	06	
3.25" – 3.75" Barrel Medium/Large Autos	Black	73IR07BK-R or L	07	
2" Barrel Small-Frame 5-Shot Revolvers with Hammer Spur Very Small-Frame .380s with Crimson Trace Laser	Black	73IR08BK-R or L	08	

Nylon Inside-the-Pants Holster

Model	Color	Part#	Size	NSN#
2" – 3" Barrel Small/Medium Double-Action Revolvers (Except 2" 5-Shot)	Black	73IP00BK (Right), 73IP00BK-L	00	
3" – 4" Barrel Medium-Frame .32/.380 Autos	Black	73IP01BK (Right), 73IP01BK-L	01	
4" Barrel Medium and Intermediate Double-Action Revolvers	Black	73IP02BK (Right), 73IP02BK-L	02	
4.5" – 5" Barrel Large Autos	Black	73IP03BK (Right), 73IP03BK-L	03	
Small Autos (.22/.25) and Very Small-Frame .32 and .380s	Black	73IP04BK (Right), 73IP04BK-L	04	
Glock 26/27/33 and other Sub-Compact 9/40	Black	73IP05BK (Right), 73IP05BK-L	05	
3.75" – 4.5" Barrel Large Autos	Black	73IP06BK (Right), 73IP06BK-L	06	
3.25" – 3.75" Barrel Medium/Large Autos	Black	73IP07BK (Right), 73IP07BK-L	07	
2" Barrel Small-Frame 5-Shot Revolvers and Very Small-Frame .380s with Crimson Trace Laser	Black	73IP08BK (Right), 73IP08BK-L	08	

Nylon Ankle Holster

Model	Color	Part#	Size	NSN#
2" Barrel Small-Frame 5-Shot Revolvers with Hammer Spur	Black	40AH00BK-R or L	00	
3" – 4" Barrel Medium-Frame .32/.380 Autos	Black	40AH01BK-R or L	01	
Small Autos (.22/.25) and Very Small-Frame .32 and .380s	Black	40AH10BK-R or L	10	
Glock 26/27/33 and other Sub-Compact 9/40	Black	40AH12BK-R or L	12	
3.25" - 3.75" Barrel Medium/Large Autos	Black	40AH16BK-R or L	16	

Nylon Ambidextrous Multi-Use Holster with Mag Pouch

Model	Color	Part#	Size	NSN#
3" – 4" Barrel Medium-Frame .32/.380 Autos	Black	40AM01BK	01	
4" Barrel Medium/Large Double-Action Revolvers	Black	40AM02BK	02	
4.5" – 5" Barrel Large Autos	Black	40AM03BK	03	
3.75" – 4.5" Barrel Large Autos	Black	40AM05BK	05	
3.25" - 3.75" Barrel Medium/Large Autos	Black	40AM06BK	06	
2" – 2.25" Small-Frame 5- and 6-Shot Revolvers with Hammer Spur	Black	40AM36BK	36	

Nylon Inside-the-Pocket Holster

Model	Color	Part#	Size	NSN#
Small Autos (.22/.25)	Black	40PP01BK	01	
Most Small-Frame .380s	Black	40PP02BK	02	
2" 5-Shot Ruger, Kel-Tec, Kahr and Taurus .380	Black	40PP03BK	03	
Most Sub-Compact 9/40 Autos	Black	40PP04BK	04	

Nylon Body Armor Holster				
Model	Color	Part#	Size	NSN#
Small Autos (.22/.25)	Black	40BA01BK	01	
Most Small-Frame .380s	Black	40BA02BK	02	
2" 5-Shot Revolvers and Very Small .380s with Laser	Black	40BA03BK	03	
Most Sub-Compact 9/.40 Autos (Up to 3 1/2" Barrel)	Black	40BA04BK	04	
Nylon Omega™ VI Elite Holster				
Model	Color	Part#	Size	NSN#
Glock 17/19/22/23/27/31/32 and Sig 226/228	Black	400D02BK-R or L	02	1095-01-422-1031 (L)
Glock 17/19/22/23/27/31/32 and Sig 226/228	Olive Drab	400D02OD-R or L	02	1095-01-422-1031 (L)
Glock 17/19/22/23/27/31/32 and Sig 226/228	Desert Tan	400D02DE-R or L	02	1095-01-422-1031 (L)
Colt 1911 45 and Browning Hi-Power	Black	400D22BK-R or L	22	
Glock 20/21 and USP .40/.45	Black	400D32BK-R or L	32	1095-01-517-6332 (L)
Beretta 92F (M9) and S&W 5906	Black	400D42BK-R or L	42	
Beretta 92F (M9) and S&W 5906	Desert Tan	400D42DE-R or L	42	
Beretta 92F (M9) and S&W 5906	ARPAT	400D42AU-R or L	42	

Craftsmanship

We've come to the conclusion that tactical knife users make the best tactical knife designers. That's why our blades are designed with input from expert knife tacticians in order to give you unparalleled quality, utility and performance. So when you're looking for big value at a price that fits your budget, choose from our expansive selection of high-quality cutting tools.

Fixed Blade Knives

Gideon™ Drop Point

The multipurpose Gideon Drop Point lets you employ the entire edge of the blade for a variety of cutting chores. Its robust, curved fixed blade is constructed of AUS8A stainless steel with a black Ti-Nitride finish. An additional finger groove in front of the quillon provides additional grip and control.

- Blade length: 5.000" /127 mm
- Overall length: 10.250"/260 mm
- Blade material: AUS8A stainless steel
- Blade finish: Black Ti-Nitride coating
- Edge type: Plain
- Handle material: CNC-machined textured G-10
- Sheath: Injection-molded nylon with mounting plates for PALS/MOLLE or drop-leg platform attachment

15DP00 | BK | \$129.99



Gideon™ Tanto

Featuring a modified "tanto" design, the fixed-blade Gideon Tanto is perfect for piercing or slashing and is ready for action when you are. The blade is constructed of AUS8A stainless steel with a black Ti-Nitride finish.

- Blade length: 5.000" /127 mm
- Overall length: 10.250"/260 mm
- Blade material: AUS8A stainless steel
- Blade finish: Black Ti-Nitride coating
- Edge type: Plain
- Handle material: CNC-machined textured G-10
- Sheath: Injection-molded nylon with mounting plates for PALS/MOLLE or drop-leg platform attachment

15TP00 | BK | \$129.99



UK-SFK™

Drawing from the groundbreaking works of Col. Rex Applegate, W.E. Fairbairn and Brent Beshara, the UK-SFK features a broad, symmetrical blade for an exceptional combination of edge geometry, point strength and penetration. It also comes complete with an integrated crossguard and distinctive full-tang handle design.

- Blade length: 6.220"/158 mm
- Overall length: 11.380"/289 mm
- Blade material: D-2 tool steel
- Blade finish: Black epoxy powder coating (Black) or brushed satin finish (Satin)
- Edge type: Plain
- Handle material: Textured G-10 scales
- Sheath: Injection-molded nylon with mounting plates for PALS/MOLLE or drop-leg platform attachment

Black | 15UK00 | BK | \$199.99

Satin | 15UK00 | SL | \$199.99



The UK-SFK™ (United Kingdom Special Forces Knife) was specifically designed for Britain's elite Special Forces and is now made available to you!

Razorback-Trocar™

Designed by expert knife tactician Massad Ayoob in cooperation with the International School of Tactical Medicine, this tactical medical knife features a zero-ground blade with scalpel-sharp tip and depth-index grooves for precise control during tactical medical procedures.

- Blade length: 3.875"/98 mm
- Overall length: 8.400"/213 mm
- Blade material: AUS8A stainless steel
- Blade finish: Black PVD coating
- Edge type: Plain or partially serrated with zero-ground tip
- Handle material: Injection-molded, fiberglass-reinforced nylon
- Sheath: Injection-molded nylon with TCCS™ Accessory/Replacement Hardware Kit (see page 165)
- Weight: 0.185 lbs. (without sheath), 0.24 lbs. (with sheath)

Plain | 15RT00 | BK | \$74.99

Serrated | 15RT10 | BK | \$74.99



Crucible FX2™

Designed by respected close-combat instructor and anti- and counter-terrorist expert Kelly McCann, the Crucible FX2 is a dependable, easily maintained and highly versatile full-tang knife crafted to meet the needs of armed professionals. Its distinctive handle profile offers the perfect combination of grip, leverage and weapon retention.

- Blade length: 3.200"/81 mm
- Overall length: 7.900"/201 mm
- Blade material: AUS8A stainless steel
- Blade finish: Black PVD coating
- Edge type: Plain or partially serrated
- Handle material: Textured G-10
- Sheath: Injection-molded nylon with TCCS™ Accessory/Replacement Hardware Kit (see page 165)
- Weight: 0.385 lbs. (without sheath), 0.455 lbs. (with sheath)

Plain | 15C200 | BK | NSN# 1095-01-529-7433 | \$129.99

Serrated | 15C210 | BK | NSN# 1095-01-525-3772 | \$129.99



NightEdge™

Designed by renowned custom knifemaker Allen Elishewitz, this full-sized fixed-blade knife incorporates a serrated back edge that optimizes the knife's utility by providing a secondary edge suitable for heavy cutting, back cuts and draw cuts. Its unique grind produces a reinforced point for extreme tip strength and penetration.

- Blade length: 5.900"/150 mm
- Overall length: 10.900"/277 mm
- Blade material: 1085C high-carbon tool steel
- Blade finish: Black epoxy finish
- Edge type: Partially serrated
- Handle material: Injection molded co-polymer with textured panels
- Sheath: Injection-molded nylon with mounting plates for PALS/MOLLE or drop-leg platform attachment

15NE10 | BK, CT | \$149.99



Kalista II™

Crafted by edged-weapons expert Michael Janich, the Kalista II is a sophisticated concealment knife specifically designed to support all knife tactic styles and grips. Its offset, scalloped choils and textured G-10 handle slabs provide exceptional control for quick knife orientation.

- Blade length: 3.300"/84 mm
- Overall length: 7.300"/185 mm
- Blade material: AUS8A stainless steel
- Blade finish: Black PVD coating
- Edge type: Plain or partially serrated
- Handle material: Textured G-10
- Sheath: Injection-molded nylon with TCCS™ Accessory/Replacement Hardware Kit (see page 165)
- Weight: 0.225 lbs. (without sheath), 0.285 lbs. (with sheath)

Plain | 15K200 | BK | \$99.99

Serrated | 15K210 | BK | \$99.99



for more:  [youtube.com/bpggear](https://www.youtube.com/bpggear)

Tatang™

Designed by edged-weapons expert Michael Janich, the Tatang employs the savage cutting power of a traditional Filipino barong in a leaner, more versatile package. When gripped at the rear of the pistol-grip-style handle, the weight-forward blade gives it tremendous reach and chopping power. Choking up on the subhilt shifts the balance back for more controlled cutting, trapping and backcutting.

- Blade length: 8.600"/218 mm
- Overall length: 13.500"/343 mm
- Blade material: 1085C high-carbon tool steel
- Blade finish: Black epoxy finish
- Edge type: Plain or partially serrated
- Handle material: Injection-molded co-polymer with textured panels
- Sheath: Injection-molded nylon with mounting plates for PALS/MOLLE or drop-leg attachments

Plain | 15TT00 | BK | \$99.99

Serrated | 15TT10 | BK | \$99.99



XSF™ Punch Dagger

The XSF Punch Dagger's distinctive handle shape delivers remarkable strength and penetration, making it a potent personal defense blade. It's designed to be braced against the palm like a traditional push dagger and guided by the index finger for increased accuracy and thrusting power.

- Blade length: 3.850"/98 mm
- Overall length: 5.275"/134 mm
- Blade material: AUS8A stainless steel
- Blade finish: Black Teflon® coating
- Edge type: Zero-ground plain
- Handle material: Textured G-10
- Sheath: Injection-molded nylon with neck chain

15PD00 | BK | NSN# 1095-01-529-7431 | \$29.99



XSF™ Micro

Designed by former Canadian Special Forces operator and custom knifemaker Brent Beshara, the XSF Micro combines extraordinary power with a sleek design to produce the ultimate personal defense weapon. Its full-tang design and textured G-10 handle scales ensure superior strength and a positive grip.

- Blade length: 3.200"/81 mm
- Overall length: 6.200"/157 mm
- Blade material: AUS8A stainless steel
- Blade finish: Black Teflon® coating
- Edge type: Zero-ground plain
- Handle material: Textured G-10
- Sheath: Injection-molded nylon with neck chain

15XM00 | BK | NSN# 1095-01-529-7430 | \$29.99

for more: [YouTube](https://www.youtube.com/bpggear)
youtube.com/bpggear



TCCS™ Accessory/Replacement Hardware Kit

Carry your Kalista II™, Crucible FX2™ or Razorback-Trocar™ in more than 70 possible configurations with this accessory hardware kit. It includes an adapter plate, neck chain, inside-the-waistband loop/snap, belt platform, paddle platform, screws, washers and complete instructions.

- Does not include sheath (sold separately with knives)
- Can be mounted to any PALS/MOLLE platform via our S.T.R.I.K.E.® Platform (sold separately, see page 129).

R1500002 | \$29.99



TCCS™ Accessory/Replacement Hardware Kit

Look for the Small Pry™ on page 96! It's a collaborative effort between our Dynamic Entry® and Knife design teams, combining specialized prying capabilities with a readily available cutting edge.

Folding Knives

CQD™ Mark I™ Type E Manual Folder

The Mark I Type E delivers cutting-edge performance with an integrated button-lock mechanism, secondary safety, recessed seat belt/cord cutter and carbide glass breaker.

- Blade length: 3.750"/95 mm
- Overall length: 9.500"/241 mm
- Blade material: AUS8A stainless steel
- Blade finish: Black PVD coating
- Edge type: Plain or partially serrated
- Handle material: Injection-molded, reinforced nylon with 420J stainless steel liners
- Pocket clip: Right- or left-side, tip-down carry
- Optional accessories: Injection-Molded Nylon Sheath (sold separately, see page 167)

Plain | 15M101 | BK, YL | \$99.99
 Serrated | 15M111 | BK, YL | \$99.99



Lower blade serration



Spear point

Reinforcement retraction nib

Carbide glass breaker



Plunge lock with accidental contact barrier
 Secondary slide safety lock

Support blade

Extended pommel

Lanyard hole

Product Tip: Use the CQD™ Mark I™ support blade for when deploying the primary blade is less effective or even dangerous. The knife's unique grip maximizes the support blade's capabilities by increasing pull-through cutting power.

CQD™ Mark I™ Aluminum Handle Manual Folder

This powerful folding knife features a meticulously machined aircraft aluminum handle, sturdy button-lock mechanism, secondary safety, carbide glass breaker, seat belt/cord cutter and improved edge geometry for unparalleled cutting performance.

- Blade length: 3.750"/95 mm
- Overall length: 9.500"/241 mm
- Blade material: 440C stainless steel
- Blade finish: Black PVD coating
- Edge type: Plain or partially serrated
- Handle material: CNC-milled anodized aircraft aluminum with rubberized insert panels
- Pocket clip: Right- or left-side, tip-down carry
- Optional accessories: Injection-Molded Nylon Sheath (sold separately, see below)
- Weight: 0.49 lbs.

Plain | 15M301 | BK | \$249.99
Serrated | 15M311 | BK | \$249.99



for more: [YouTube](https://www.youtube.com/bpggear)
[youtube.com/bpggear](https://www.youtube.com/bpggear)

Injection-Molded Nylon Sheath for CQD™ Mark I™

Carry your CQD Mark I Type E Manual Folder or CQD Mark I Aluminum Handle Manual Folder in this durable, custom-molded sheath. It allows both models to be carried in the open position like a fixed-blade knife.

- Weather-resistant construction
- Designed for immediate combat draw
- Dual adjustable tension screws
- Holds automatic and manual versions of the CQD™ Mark I™
- Includes Mod-U-Lok™ Platform (see page 131) and interface plate for full 360-degree mounting on belts or other hardware
- Mounts to any PALS/MOLLE platform via our S.T.R.I.K.E.® Platform (sold separately, see page 129)

200 | BK | \$39.99



CQD™ Mark II™ Type E Manual Folder

Featuring a re-engineered button-lock mechanism, carbide glass breaker, secondary safety lock and tungsten DLC-coated TORX® clip screws, the compact Mark II Type E Manual Folder delivers outstanding cutting power in a low-profile package.

- Blade length: 3.300"/84 mm
- Overall length: 7.950"/202 mm
- Blade material: AUS8A stainless steel
- Blade finish: Black PVD coating
- Handle material: Injection-molded, reinforced nylon with 420J stainless steel liners
- Edge type: Plain or partially serrated
- Pocket clip: Right- or left-side, tip-down carry

Plain | 15M201 | BK | \$79.99
Serrated | 15M211 | BK | \$79.99



CQD™ Mark II™ Aluminum Handle Manual Folder

This field-proven design features a meticulously machined aircraft aluminum handle, high-strength button-lock mechanism, secondary safety and carbide glass breaker. It also comes equipped with an internal blade-stop pin, tungsten DLC-coated TORX® clip screws and enhanced edge geometry for superior cutting performance. Its ergonomic, non-slip handle houses a reversible spring-steel clip for convenient carry options.

- Blade length: 3.300"/84 mm
- Overall length: 7.950"/202 mm
- Blade material: 440C stainless steel
- Blade finish: Black PVD coating
- Edge type: Plain or partially serrated
- Handle material: CNC-milled, anodized aircraft aluminum with rubberized insert panels
- Pocket clip: Right- or left-side, tip-down carry
- Weight: 0.275 lbs.

Plain | 15M401 | BK | \$199.99

Serrated | 15M411 | BK | \$199.99



Did you know? The CQD™ Mark I™ and Mark II™ were designed specifically for military and law enforcement professionals by Duane Dieter, renowned close-quarters tactical expert and special operations trainer.



Hornet II™

Designed by legendary edged-weapons expert James Keating, this powerful tactical folding knife features a heavy-duty liner-lock mechanism and ambidextrous thumb stud, making it a dependable, versatile cutting tool.

- Blade length: 3.100"/79 mm
- Overall length: 7.200"/183 mm
- Blade material: AUS8A stainless steel
- Blade finish: Black PVD coating
- Edge type: Plain or partially serrated
- Handle: 420J stainless steel liners nested in textured G-10 scales
- Pocket clip: Right- or left-side, tip-up or tip-down carry

Plain | 15H201 | BK | \$99.99

Serrated | 15H211 | BK | \$99.99



Medium CORDURA® Belt Pouch WHILE SUPPLIES LAST

This black pleated belt pouch fits the Hornet II™ or any folding knife of similar size (approximately 4.000"/102 mm closed).

204-M | Black | \$9.99

Point Man™

The Point Man—a full-service tactical folding knife—features a signature ergonomic handle, distinctive spearpoint blade, improved lock geometry and high-strength liner-lock mechanism.

- Blade length: 3.400"/86 mm
- Overall length: 7.800"/198 mm
- Blade material: AUS8A stainless steel
- Blade finish: Black PVD coating
- Edge type: Plain or partially serrated
- Handle material: 420J stainless steel liners nested in textured G-10 scales
- Pocket clip: Right- or left-side, tip-up or tip-down carry

Plain | 15PM01 | BK | \$99.99

Serrated | 15PM11 | BK | \$99.99



Crucible II™ Folder

The dependable, folding Crucible II features a flush-ground liner-lock locking mechanism for dependable weapon security and Phillips-head screws for easy user maintenance.

- Blade length: 3.250"/83 mm
- Overall length: 8.000"/203 mm
- Blade material: AUS8A stainless steel
- Blade finish: Black PVD coating
- Edge type: Plain or partially serrated
- Handle material: Textured G-10
- Pocket clip: Right- or left-side, tip-up or tip-down carry
- Weight: 0.39 lbs. (without sheath), 0.46 lbs. (with sheath)

Plain | 15C201 | BK | \$89.99

Serrated | 15C211 | BK | \$89.99



Garra II™

The Garra II—our representation of the ultimate hawkbill/karambit-style folding knife—is strategically designed to align with the natural grip angle of your hand, making it perfect for maximizing cutting power. An extended tang delivers focused impact when the knife is in the closed position, and a high-strength liner-lock mechanism provides additional weapon security.

- Blade length: 3.000"/76 mm
- Overall length: 7.400"/188 mm
- Blade material: AUS8A stainless steel
- Blade finish: Black PVD coating
- Edge type: Plain or partially serrated
- Handle material: 420J stainless steel liners nested in textured G-10 scales
- Pocket clip: Right-side, tip-down carry

Plain | 15G201 | BK | NSN# 1095-01-529-7433 | \$99.99

Serrated | 15G211 | BK | NSN# 1095-01-529-7432 | \$99.99



HawkPoint™

The HawkPoint is versatility at its finest! The robust, curved blade is constructed of AUS8A stainless steel and is designed for using the entire edge of the knife.

- Lanyard hole
- Wire stripper
- Bottle opener/pry tool
- Ambidextrous thumb stud
- Frame-lock locking mechanism
- Sturdy spine with drop-point blade
- Blade length: 2.375"/60 mm
- Overall length: 5.625"/143 mm
- Blade material: AUS8A stainless steel
- Blade finish: Black PVD coating
- Handle material: Injection-molded, fiberglass-reinforced nylon with 420J2 stainless steel liners
- Edge type: Plain or partially serrated
- Pocket clip: Right side, tip-down carry
- Weight: 0.25 lbs.

Plain | 15HP01 | BK | \$44.99
Serrated | 15HP11 | BK | \$44.99



for more: [YouTube](https://www.youtube.com/bpggear)
[youtube.com/bpggear](https://www.youtube.com/bpggear)

HawkHook™

Having a rescue tool with you 24/7 has never been so convenient or affordable. The HawkHook's blade locks open via a stout frame-lock mechanism in the handle.

- Lanyard hole
- Glass breaker
- Wire stripper
- Bottle opener
- Flat screwdriver/pry tip
- Ambidextrous thumb stud
- Recessed seat belt/cord cutter
- Blade length: 2.250"/57 mm
- Overall length: 5.500"/140 mm
- Blade material: AUS8A stainless steel
- Blade finish: Matte bead-blast finish
- Edge type: Combination plain/partially serrated
- Handle material: 420J stainless steel with textured nylon scale
- Pocket clip: Right-side, tip-down carry

15HH11 | SL, YL | \$39.99



for more: [YouTube](https://www.youtube.com/bpggear)
[youtube.com/bpggear](https://www.youtube.com/bpggear)

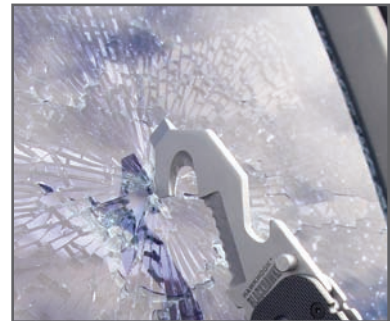

Use the glass-breaker feature with a hammer-like motion, keeping your hands away from sharp glass during window breaching.

BHB30™ WHILE SUPPLIES LAST

The BHB30 is an extremely reliable assisted-opening knife. When its 440C stainless steel blade is opened to approximately 30 degrees, a powerful spring in the handle snaps the blade to the fully opened position. A stout 420J stainless steel liner-lock locking mechanism secures the blade in place while a tiger-striped handle provides a secure grip.

- Blade length: 3.250"/83 mm
- Overall length: 8.125"/206 mm
- Blade material: 440C stainless steel
- Blade finish: Stonewashed matte
- Edge type: Plain
- Handle material: 420J stainless steel liners nested in injection-molded nylon scales
- Pocket clip: Right- or left-side, tip-up or tip-down carry

153001 | SL | \$139.99



Be-Wharned™

Thanks to the efforts of edged-weapons designer and trainer Michael Janich, the Be-Wharned has become one of the most functional and advanced tactical folding knives available today and has earned a reputation as an incredibly potent personal defense tool. This popular wharncliffe blade design utilizes a sturdy liner-lock mechanism for secure weapon handling.

- Blade length: 3.400"/86 mm
- Overall length: 7.850"/199 mm
- Blade material: AUS8A stainless steel
- Blade finish: Satin finished
- Edge type: Plain
- Handle material: 420J stainless steel liners nested in textured G-10 scales
- Pocket clip: Right- or left-side, tip-up or tip-down carry

15BW01 | SL | \$99.99





Initial Response "H" Harness

- Compatible with Initial Response Web Belt (see page 85)
- Padded shoulder straps with reflective gray piping
- Helps distribute belt weight evenly

35ES00 | BK | \$29.99



Load Bearing Suspenders

- Wraparound belt loop system
- Heavy-duty drag handles and sternum strap
- No metal attachment clips
- Belt not included

35LBS1 | BK, OD | \$39.99



Special Operations H-Gear Shoulder Harness

- Constructed of dual-layer 1000 denier nylon and .375" closed-cell foam padding
- Fully adjustable and attaches to any belt up to 2.25" wide (sold separately, see page 81 – 85)
- Heavy-duty drag handle

35SS00 | BK | \$39.99

Did you know? To meet the critical demands of first responders, we developed the modular Initial Response system—a series of unique interchangeable gear, including packs, belts, harnesses and vests. See other Initial Response gear on page 72, 77, 85 and 260.

Enhanced Soldier Load Bearing Vest

- Constructed of dual-layer 1000 denier nylon with mesh panels
- Contoured shoulder straps with .5" closed-cell foam padding
- Heavy-duty drag handle
- High-quality YKK® zippers on internal mesh compartment panels
- Includes four mag pouches with dividers (each holds two M16/M4 magazines)
- Includes two grenade pouches
- Stealth snap and hook & loop closures on all pouches
- Pouches include grommets for drainage
- S.T.R.I.K.E.® webbing on side and back for attaching pouches or accessories
- Metal D-rings for buttpack attachment
- Belt loops secure vest to any web belt (sold separately, see page 81 – 85)
- Accommodates 100-oz. hydration system (sold separately, see page 80)

31SF03 | DE | \$149.99



Cases and Mats

Each long gun case and mat is constructed of 1000 denier nylon for highly resilient, abrasion-resistant, quick-drying performance. They're built to withstand severe use thanks to the following standard features:

- Double-stitched seam taping on raw edges
- Box X-anchor stitching on drag handles
- Full wraparound carry handles with heavy-duty webbing
- Lightweight closed-cell foam padding does not absorb moisture or perspiration



Divided Rifle Case **NEW!**

Securely transport up to two long guns in the fully padded, tough-as-nails Divided Rifle Case.

- Includes all Cases and Mats standard features (see top of page)
- Removable, adjustable shoulder strap with non-slip shoulder pad
- Padded divider and increased depth to fit two long guns
- YKK #10 self-healing coil zippers with silent zipper pulls
- Four external mag pouches with adjustable lids (each holds up to two magazines)
- Large external accessory pocket with zipper closure
- Dimensions: 38"L x 3.9"W x 12.5"D
- Weight: 4.1 lbs.



64RC00 | BK | \$169.99

Homeland Security Discreet Case

Using quality materials and craftsmanship, the Homeland Security Discreet Case can be used in combination with our hook & loop pouches and configured for any mission.

- Includes all Cases and Mats standard features (see top of page)
- Full-opening zipper for shooting mat configuration
- Removable, adjustable shoulder strap with non-slip shoulder pad
- External zipper pocket lined with bed of hook & loop to attach any hook & loop pouches
- Includes removable Triple M16 Mag Pouch (see page 208)
- Dimensions: 22"L x 2"W x 10"D (65DC22), 29"L x 2"W x 10"D (65DC29), 32"L x 2"W x 13"D (65DC32), 35"L x 2"W x 10"D (65DC35), 40"L x 2"W x 12"D (65DC40)



MP5 | 65DC22 | BK | \$109.99

HK94 MP5 | 65DC29 | BK | NSN# 1095-01-517-7043 | \$119.99

CAR 15 | 65DC32 | BK | NSN# 1080-01-563-5360 | \$129.99

CAR 15/M4 | 65DC35 | BK, DE | \$139.99

M16 | 65DC40 | BK, DE | NSN# 1095-01-529-5775 | \$149.99



Padded Weapons Case

Carry a single long gun or two side by side in the Padded Weapons Case. A padded, zippered external utility pouch holds a handgun or accessories for additional storage options.

- Includes all Cases and Mats standard features (see page 173)
- Full-opening zipper for shooting mat configuration
- Removable, adjustable shoulder strap with non-slip shoulder pad
- Internal divider to carry up to two weapons side by side
- Large external utility pouch secured by hook & loop
- Dimensions: 38"L x 3.5"W x 14"D (61PW00), 44"L x 3.5"W x 14"D (61PW01)

38" | 61PW00 | BK | NSN# 1095-01-517-7102 | \$139.99

44" | 61PW01 | BK | NSN# 1095-01-517-7104 | \$149.99



Rifle Case

If you need a high-quality protective carry case for your valuable firearms, then our Rifle Case is for you! It's made with padded .375" closed-cell foam to absorb the shock but not water.

- Includes all Cases and Mats standard features (see page 173)
- Full-opening zipper for shooting mat configuration
- Removable, adjustable shoulder strap with non-slip shoulder pad
- High-quality YKK® zippers and sliders
- Removable foam inserts
- Four external mag pouches with adjustable lids
- Dimensions: 34"L x 2.5"W x 11.5"D (64RC34), 37"L x 2.5"W x 11.5"D (64RC37), 41"L x 2.5"W x 11.5"D (64RC41), 46"L x 2.5"W x 10"D (64RC46)

34" | 64RC34 | BK | \$99.99

37" | 64RC37 | BK | \$99.99

41" | 64RC41 | BK | \$109.99

46" | 64RC46 | BK | \$114.99



Scoped Rifle Case

Our Scoped Rifle Case is constructed of the same high-quality materials as our original Rifle Case but incorporates a zippered cargo compartment to replace the magazine pouches.

- Includes all Cases and Mats standard features (see page 173)
- Full-opening zipper for shooting mat configuration
- Removable, adjustable shoulder strap with non-slip shoulder pad
- High-quality YKK® zippers and sliders
- Dimensions: 46"L x 2.5"W x 10"D (64SR46), 51"L x 2.5"W x 10"D (64SR51)
- Weight: 3.3 lbs. (64SR46), 3.55 lbs. (64SR51)

46" | 64SR46 | BK | \$104.99

51" | 64SR51 | BK | \$114.99





Weapon Transport Case

Constructed of durable 1000 denier nylon and .375" closed-cell foam, our Weapon Transport Case is designed to carry multiple weapons safely.

- Includes all Cases and Mats standard features (see page 173)
- Full-opening zipper for shooting mat configuration
- Removable, adjustable shoulder strap with non-slip shoulder pad
- Padded, removable divider for side-by-side weapon storage
- Fully padded external pocket with universal holster for pistol and accessories
- Dimensions: 41"L

66WT00 | BK, OD | NSN# 9999-01-543-9820 (BK) | \$139.99

Pistol/accessory compartment



Shotgun Case

Padded with .375" closed-cell foam, our Shotgun Case is constructed of abrasion- and mildew-resistant 1000 denier nylon for long-lasting durability.

- Includes all Cases and Mats standard features (see page 173)
- Full-opening zipper for shooting mat configuration
- Removable, adjustable shoulder strap with non-slip shoulder pad
- Designed to hold standard stock 18" – 22" barrels
- High-quality YKK® zippers and sliders
- Dual-slider zippered utility pocket and pouches
- Dimensions: 43"L x 2"W x 8"D

64SG43 | BK | \$99.99



Long Gun Sniper Drag Bag

Currently in use with the Special Forces, the Long Gun Sniper Drag Bag gives you the best quality and weapon protection possible.

- Includes all Cases and Mats standard features (see page 173)
- Full-opening zipper for shooting mat configuration
- High-quality YKK® zippers and sliders
- Detachable shoulder straps for muzzle-up or muzzle-down carry
- Reinforced drag handle
- Loops for Ghillie attachment
- Internal weapon-securing straps
- Two internal utility pouches
- Front/rear cargo pouches with internal straps
- Dimensions: 51"L (total), 9.5"L x 12"W x 2"D (rear pouch), 8.5"L x 23"W x 2"D (front pouch)

20DB01 | BK, OD, DE | NSN# 1095-01-521-9357 (BK), NSN# 1095-01-521-9342 (OD), NSN# 1095-01-521-9340 (DE) | \$284.99

Stalker Drag Mat

The multifunctional Stalker Drag Mat is ideal for use as a shooting mat, rifle carry case or drag bag.

- Includes all Cases and Mats standard features (see page 173)
- Removable, adjustable shoulder strap with non-slip shoulder pad
- Internal weapon-securing straps
- Elastic loops with protective flap hold 10 rounds of .308 ammo
- Internal data book pocket
- Dimensions: 50.5"L (total), 32"W (open bottom)

80DM00 | BK, OD | NSN# 8465-01-517-7048 (BK), NSN# 8465-01-517-7049 (OD) | \$159.99



Pro-Shooters Mat

The Pro-Shooters Mat is ideal for any type of rifle, pistol or shotgun competition that requires multiple shooting positions. It has a hydration-compatible pouch with tube-routing system and rolls up for compact carry configuration.

- Includes all Cases and Mats standard features (see page 173)
- Removable, adjustable shoulder strap with non-slip shoulder pad
- Accommodates 100-oz. hydration system (sold separately, see page 80)
- Heavy-duty carry handle
- Non-slip shooting surface
- Dimensions: 83"L x 28"W

80CM00 | BK, OD, DE | NSN# 8465-01-517-7047 (BK), NSN# 8465-01-517-7050 (OD), NSN# 8320-01-521-9361 (DE) | \$164.99



Padded Scope and Crown Protector **NEW!**

This combo scope/crown cover keeps the most vital parts of your precision rifle fully insulated and protected.

- Constructed of 500 denier ripstop (solid colors) or CORDURA® nylon (MultiCam®)
- Closed-cell foam padding
- Crown protector can be separated from scope cover
- Durable carry handle
- Adjustable three-strap fit

- Dimensions: 18"L x 5"W (scope cover), 10"L x 3.75"W (crown cover)
- Weight: 0.62 lbs.

62SP02 | BK, CT, OD, MC | NSN# 6650-01-517-7863 (BK), NSN# 6650-01-517-7866 (OD) | \$35.99 (MC = \$51.99)

Long Gun Pack Mat

A true professional deserves the Long Gun Pack Mat for maximized performance in any condition or on any mission. It can be used as a rifle carrying case, backpack, jungle drag bag or shooting mat, and it comes complete with removable pouches for a notebook, cleaning kit, cartridges or bolts.

- Includes all Cases and Mats standard features (see page 173)
- Full-opening zipper for shooting mat configuration
- Accommodates 100-oz. hydration reservoir (sold separately, see page 80)
- High-quality YKK® zippers and sliders with silent zipper pulls
- Hard plastic protective crown cover lined with closed-cell foam
- Zippered backpack compartment rolls up for convenient storage when deployed
- Concealable backpack harness straps and belt
- Elasticized sternum strap for comfortable carry
- Fits all rifles up to 50" long
- Freefall and static-line jumpable
- Dimensions: 49"L x 28"W

20PM03 | BK, OD, DE | NSN# 8465-01-517-4413 (BK), NSN# 8465-01-517-4414 (OD) | \$249.99



Zippered backpack compartment



Fits all rifles up to 50" long



Pack can be converted to reveal padded backpack harness straps and belt

Tactical Slings

Universal Swift Sling

Get more than 60 possible sling configurations and quick shoulder-to-shoulder transitions with the Universal Swift Sling. Designed for fixed or collapsible stocks, this versatile three-point sling features a quick cam buckle for rapid one-hand adjustment.

- Constructed of high-quality 1.25" nylon webbing
- Heavy-duty tri-glide buckle, metal oval ring and single 300-lb. test side-release buckle for quick sling detachment, firearm attachment, and weapon removal
- Fully adjustable, ambidextrous design

70GS17 | BK, CT, MC | \$39.99 (MC = \$49.99)



Get 60+ possible sling configurations with the Universal Swift Sling!

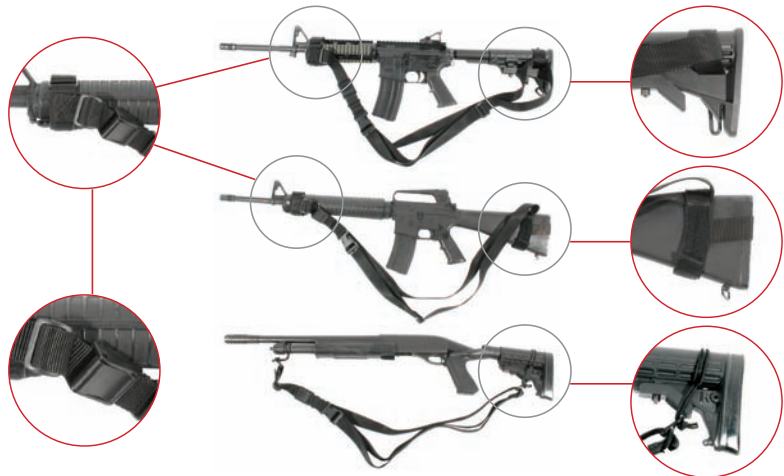

Quick Shoulder-to-Shoulder Transition



1. Ready position



2. Strong side mount



3. Release of quick cam buckle



4. Transition to support side mount

STORM Sling™ RS **NEW!**

Get superior quality in a high-speed package with the STORM Sling RS (Rapid Slide). Featuring a simple yet robust design, this ambidextrous single-point sling helps improve firearm agility and CQB tactics while delivering quick shoulder-to-shoulder transitions.

- Constructed of high-quality 1.25" nylon webbing
- High-strength, smooth elliptical bungee for improved firearm agility and CQB tactics
- Rapid-release buckle for easy and safe sling removal
- Removable forged snap hook for quick and positive firearm attachment
- Integrated release buckle for convenient firearm attachment or removal
- Heavy-duty tri-glide buckle for proper fit

70GS20 | BK, CT, MC | \$39.99 (MC = \$49.99)



STORM Sling™

This unique single-point sling is constructed of high-strength 1.25" wide nylon webbing with an elliptical bungee for comfort and support. It adjusts from 46" to 64" in diameter and also features robust bar tacking and box stitching for maximum strength.

- Compressed tubular nylon sheathing limits bounce and enhances retention
- Elastic-encased MASH Clip for quick, positive firearm attachment
- Heavy-duty tri-glide buckle, metal oval ring and single 300-lb. test side-release buckle for quick sling attachment and removal
- 4" flex for weapon agility and CQB tactics
- Adjusts from 46" to 64" in diameter to fit all body sizes and around bulky tactical vests or gear

70GS12 | BK | \$32.99



STORM Sling™ QD

This user-friendly single-point sling adjusts from 30" to 50" in diameter with a tri-glide buckle to fit all body sizes and around bulky vests or gear. Like the XT, the QD features a removable, elastic-encased MASH Clip for quick, positive firearm attachment and robust bar tacking and box stitching for maximum strength.

- Constructed of high-quality 1.25" wide nylon webbing
- Heavy-duty tri-glide buckle, metal oval ring and single 300-lb. test side-release buckle for quick firearm attachment and removal

70GS15 | BK | \$24.99



Quick firearm attachment/detachment

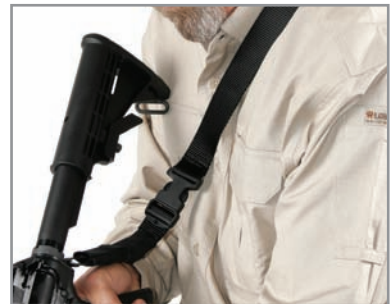

STORM Sling™ XT

With four inches of flex for weapon agility, this single-point sling adjusts from 46" to 64" in diameter to fit all body sizes and around bulky vests or gear. An elliptical bungee provides comfort and support while compressed tubular nylon sheathing limits bounce and enhances retention.

- Constructed of high-quality 1.25" wide nylon webbing
- Removable, elastic-encased MASH clip for quick, positive firearm attachment
- Heavy-duty tri-glide buckle, metal oval ring and dual 300-lb. test side-release buckles for quick sling detachment, firearm attachment and weapon removal
- 4" flex for weapon agility and CQB tactics
- Robust bar tacking and box stitching for maximum strength
- Durable quick-release buckle

70GS16 | BK, CT, MC | \$39.99 (MC = \$49.99)



STORM Sling™ XT/QD and Sub-Gun Sling Quick Disconnect Attachment

- Extra attachment assembly for multiple firearms

70SA02 | BK | \$14.99



70SA02



Robust quick-release buckle

QD Swivel Sling Adapter

- Heavy-duty QD swivel
- Compatible with STORM Sling™ RS, QD, XT (see page 178 – 179) and Sub-Gun Sling (see below)

70SA03 | BK | \$21.99



70SA03

Sub-Gun Sling

Constructed of durable 1" wide tubular nylon webbing, this single-point sling features an elliptical bungee for additional support and 12" flex for weapon agility and CQB tactics. The Sub-Gun Sling is also equipped with a heavy-duty tri-glide buckle, metal oval ring and single 300-lb. test side-release buckle for quick firearm attachment and removal.

- Removable, elastic-encased 1" snap hook for quick, positive firearm attachment with additional 6" of possible sling length adjustment
- Adjusts from 36" to 44" in diameter to fit all body sizes and around bulky tactical vests or gear
- Robust bar tacking and box stitching for maximum strength

70GS14 | BK | \$32.99



Quick firearm attachment/detachment



Looking for single-point sling attachments and accessories? See page 191 – 194.

Dieter CQD Sling with Sling Cover

Designed by special operations trainer Duane Dieter, this hybrid single-point/two-point sling incorporates heavy-duty elastic to help assist with strikes and point shooting as well as quick adjustment in difficult situations.

- Constructed of 1.25" wide T-13 webbing (softer than standard webbing)
- Adjustable design to fit all operators
- Single-point or two-point configuration
- Metal snap hooks attach to most weapon systems, brackets or attachment buckles

71CQS1 | BK | NSN# 8415-01-504-3087 | \$44.99



Tactical Releasable S.T.R.I.K.E.® Sling

Made with heavy-duty elliptical bungee and tubular nylon webbing, this fully adjustable tactical sling features a metal snap hook at both ends for convenient attachment to most weapon systems, brackets, attachment buckles or even S.T.R.I.K.E.® webbing.

- Adjustable design to fit all operators
- Side-release buckle for quick firearm attachment and removal
- Secure three-point cop-lock buckle in the middle for easy weapon removal from attaching point on vest or other platform

70GS13 | BK | \$32.99



Rapid-Adjust Two-Point Sling

This sleek two-point sling is ideal for fast transitions, stable shooting positions and secure carry options. It's constructed of high-quality 1.25" wide nylon webbing and is a fully ambidextrous, adjustable design.

- Quick-adjust buckle for easy shoulder-to-shoulder or firearm transition
- Top-grade materials deliver years of reliable performance

70GS18 | BK | \$32.99



Swift Machine Gun Sling (S.A.W./M-240/M-60)

The fully ambidextrous three-point Swift Machine Gun Sling is designed specifically for Squad Automatic Weapons.

- Robust metal snap hooks attach to sling swivels or ring mounts
- Detachable sling pad made with .375" closed-cell foam to comfortably carry heavy weapons
- In-line quick-release design for quick transition from patrol carry to right or left shoulder firing position

70GS09 | BK | \$47.99





MP-5 Sling

Designed for the MP-5 submachine gun and similar weapons, this simple yet hardwearing two-point sling is an effective solution to close-quarter situations.

- Constructed of high-quality 1.25" wide webbing (soft to avoid neck chafing)
- Heavy-duty tri-glide buckles and metal oval rings

70GS08 | BK | NSN# 8415-01-504-3070 | \$34.99



Universal Tactical 1.25" Sling

This simple two-point nylon web design is the perfect choice for those who want a quality sling without breaking the bank.

- Fully adjustable and ambidextrous to fit any shooter

70UT00 | BK | \$10.99



Shotgun Shell Sling

The adjustable two-point Shotgun Shell Sling is designed to carry 15 extra shells for quick access.

- Constructed of high-quality 2" wide nylon webbing
- Elastic straps holds 15 extra shells
- Attaches to standard sling swivels with durable steel spring hooks

43SS15 | BK | NSN# 1398-01-520-7279 | \$21.99

Hunting Slings



Kudu Stretch Sling

When it comes to carrying your shotgun or rifle for hours at a time, you want a sling that will give you miles of comfort. The ambidextrous Kudu Stretch Sling features elastic webbing that conforms to your shoulder and non-slip rubber ribs to keep the sling in place.

- Constructed of high-quality 2" wide nylon webbing
- Fully adjustable length to fit all body sizes
- Compatible with a wide variety of rifles and shotguns
- Includes two 1" LOK-DOWN™ swivels (see page 192)

73KS01 | BK, CT | \$26.99

Trophy Padded Sling

Featuring a reinforced, quilted, closed-cell foam shoulder pad, the Trophy Padded Sling delivers maximum comfort for long days in the field. It's constructed using abrasion-resistant 1" wide CORDURA® nylon webbing, making it extremely durable and completely resistant to mildew or rot.

- Non-slip backing keeps sling in place
- Heavy-duty buckles and keepers
- Available with or without swivels
- Includes four cartridge loops (73NS04 only)
- Dimensions: 48"L x 1"W (73NS04, 73NS05, 73NS06), 72"L x 1"W (73NS07, 73NS09)

48" x 1" Shotgun (with Cartridge Loops, without Swivels) | 73NS04 | BK | \$19.99

48" x 1" Rifle (without Swivels) | 73NS05 | BK, M1 | \$16.99 **WHILE SUPPLIES LAST (M1)**

72" x 1" Rifle (without Swivels) | 73NS07 | BK | \$16.99

72" x 1" Shotgun (without Swivels) | 73NS09 | BK | \$18.99



Performance Stretch Sling

The Performance Stretch Sling is constructed of high-quality, elastic nylon webbing and flexible, closed-cell neoprene padding while non-slip backing makes the sling hug your shoulder for hours of comfortable carry.

- Available with or without swivels
- Includes four cartridge loops (73HS01BK, 73HS01M1 and 73HS00BK only)

Rifle (without Swivels) | 73HS04 | BK | \$15.99

Rifle (without Swivels) | 73HS02 | M1 | \$17.99

Shotgun (without Swivels) | 73HS05 | BK | \$20.99

Shotgun (without Swivels) | 73HS03 | M2 | \$19.99

Rifle (with Swivels) | 73HS06 | BK | \$22.99

Shotgun (with Cartridge Loops, without Swivels) | 73HS01 | BK | \$19.99

Shotgun (with Cartridge Loops, without Swivels) | 73HS01 | M1 | \$19.99

Shotgun (with Cartridge Loops, with Swivels) | 73HS00 | BK | \$24.99



73HS04BK
Black

73HS03M2
Mossy Oak
Shadow
Grass®

73HS01M1
Mossy Oak
Break-Up®





Mountain Sling

Sometimes simple gear is better—especially if it saves weight on a hunt. Our weatherproof Mountain Sling offers simplicity with just enough substance to make it indispensable in your hunting kit.

- Constructed of high-quality 1.25" wide nylon webbing
- Non-slip backing keeps sling in place
- Two all-steel, blued LOK-DOWN™ swivels for easy attachment to BLACKHAWK!® or most other swivel bases
- One-hand operation

73SM00 | BK | \$18.99



Pro Shooter's Forearm Sleeve **NEW!**

- Forearm shotgun shell holder designed for quick and efficient shotgun reloads
- Holds eight shotgun shells in 1" elastic retainers
- Three hook & loop-secured elastic straps for adjustable fit
- Weight: 4 oz.

80FS00 | BK, CT | \$24.99



CQD® Mark III™ Stealth Weapons Catch

Designed by Duane Dieter for demanding law enforcement and military environments, the Stealth Weapons Catch is ultra quiet with no hook & loop or snaps. Its robust spring-steel catch guarantees years of reliable performance in the harshest conditions.

- Ambidextrous design
- Adjustable, removable elastic weapon retention strap
- Secures shotguns, rifles, less-than-lethal weapons and manual entry tools
- Includes two Speed Clips™ (see page 214) for S.T.R.I.K.E.® webbing attachment and two metal ALICE Clips (see page 214) for belt mounting

71WC00 | BK, CT | \$34.99



CQD® Mark I™ and Mark II™ Weapons Catch

Created by tactical expert Duane Dieter, the CQD Weapons Catch delivers weapon security and retention while providing immediate access. Both the Mark I and II versions secure rifles, shotguns, sub-machine guns, tear gas launchers, non-lethal weapons, manual entry tools and other special-use weapons. It can be used in two basic methods: 1) Quick catch for moderate physical activity or quick response. 2) Retention catch for intense physical activity or when total retention is necessary.

- Adjustable retaining strap for various weapons
- Ambidextrous and compact (one size fits all)
- Compatible with existing equipment systems
- Mark II™ version includes polymer hook for fast clip action and silent operation

Mark I™ | 71CQD1 | BK | NSN# 8465-01-491-4398 | \$36.99

Mark II™ | 71CQD2 | BK | NSN# 8465-01-491-4509 | \$44.99

Buttstock Shotgun Shell Pouch

- Fully ambidextrous design
- Constructed of lightweight nylon ripstop (pouch and lid)
- Shells are secured by elastic and protected by pouch and cover flap with hook & loop closure
- Holds five 2.25" or 3" shells
- Dual holding points for security
- Dimensions: 5"L x 2"W x 0.875"D
- Weight: 3.4 oz.

52BS02 | BK | \$26.99



M4 Collapsible Stock Mag Pouch

- Constructed of lightweight nylon ripstop
- Fits most collapsible stock designs
- Adjustable lid for 20- or 30-round magazines
- Dimensions: 3"L x 4.125"W x 1"D
- Weight: 3.3 oz.

52BS17 | BK, DE | \$24.99



Buttstock Magazine Pouch

- Constructed of lightweight 500 denier Kodra® ripstop
- Compatible with all standard fixed buttstocks, most rifle magazines and most collapsible stock designs
- Adjustable lid accommodates 20-round or 30-round magazines
- Elastic forward-slip protection strap on back
- Adjustable straps for secure hold
- Dimensions: 3"L x 4.125"W x 1"D
- Weight: 3.3 oz.

52BS16 | BK | \$25.99

52BS16 | OD | \$25.99 **WHILE SUPPLIES LAST**

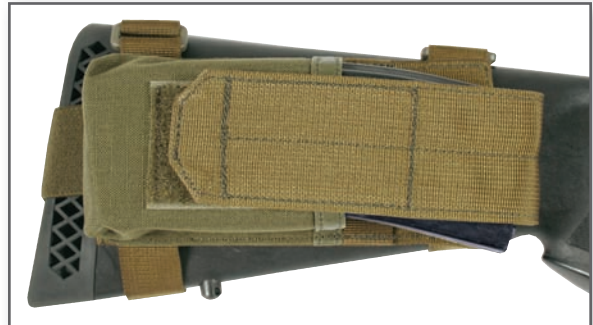

AR-15 Cheek Pad

- Cutout for use with AR-15/M16 rifles
- 0.75" adjustable straps with 0.2" retaining strap to prevent forward slip
- Three pieces of removable foam for height adjustment and proper eye relief
- Non-slip outer shell
- Dimensions: 5"L x 6.75"W = 33.75 sq. in.

90CP09 | BK | \$19.99



Tactical Cheek Pad

- Non-slip material for positive cheek weld
- Height-adjustable inserts
- Three adjustable straps with end retaining strap to prevent forward slip

90CP01 | BK | \$29.99



Rifle Cheek Pad

- Constructed of 1000 denier nylon and closed-cell foam
- Aids eye relief efficiency, prevents slipping and reduces recoil to neck and cheek
- Adjustable tie-down system fits all rifle stocks

90CP00 | BK | NSN# 1005-01-517-7052 | \$19.99



Ammo Cheek Pad

- Constructed of 1000 denier nylon
- Non-slip material for positive cheek weld
- Allows for quick reload and instant visual of ammo status
- Zippered utility pouch for external ammunition storage
- Patent pending

90CP02 | BK | NSN# 1005-01-517-7051 | \$34.99



Urban Warfare IVS™ Performance Ventilating Cheek Pad **NEW COLORS!**

- IVS™ compression-molded technology for enhanced performance
- Compressed spider design optimizes cheek weld, eye relief and ventilation for extended use
- Raises comb height for improved alignment with large tactical scopes
- Zippered utility pouch and external ammunition storage

90CP05 | BK, CT, OD, MC | \$44.99 (MC = \$47.99)



Buttstock Shell Holder (Open)

- Open style
- Elastic sleeve slips over rifle or shotgun stock for quick ammo access
- Sewn-on elastic loops keep ammo in place
- Rifle model includes nine ammo loops
- Shotgun model includes five ammo loops

Rifle | 74SH00 | BK | \$10.99
Shotgun | 74SH02 | BK | \$10.99



Buttstock Shell Holder with Flap

- Elastic sleeve slips over rifle or shotgun stock for quick ammo access
- Sewn-on elastic loops keep ammo in place
- Hook & loop CORDURA® flap
- Rifle model includes six ammo loops
- Shotgun model includes five ammo loops

Rifle | 74SH01 | BK | \$15.99
Shotgun | 74SH03 | BK | \$15.99



On-Gun Components

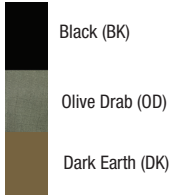

Folding Rear BUIS (Back-Up Iron Sight) **NEW!**

- Optimized for AR platform
- Compatible with MIL-spec height front AR sights
- Single "hybrid" aperture for simplicity
- Locks into stowed position with push-button-actuated spring deployment
- Aluminum sight blade/aperture and polymer base for optimal strength-to-weight ratio

71BU01 | BK, OD, DK | \$59.99



Folding Front BUIS (Back-Up Iron Sight) **NEW!**

- Optimized for AR platform
- Compatible with MIL-spec height rear AR sights
- Utilizes standard MIL-spec front sight posts and sight adjustment tools
- Locks into stowed position with push-button-actuated spring deployment
- Aluminum tower body and polymer base for optimal strength-to-weight ratio
- Circular hood protects sight post and increases speed acquiring sight picture

71BU02 | BK, OD, DK | \$59.99



Rail Mount Thumb Rest **NEW!**

- Provides a reference point on forend for consistent grip
- Improves weapon manipulation and control
- Enhances function of other accessories such as vertical grips
- Can be inverted to provide both high and low grip options
- Symmetrical design for ambidextrous use
- Constructed of high-performance fiberglass glass-reinforced polymer
- Fits Picatinny style rails
- Sold individually only

71RM00 | BK, OD, DK | \$19.99



AR Fixed BUIS (Back-Up Iron Sight) **NEW!**

- Same plane aperture with no vertical or horizontal point-of-impact shift when switching from precision to CQB
- Compatible with MIL-spec front sights
- 6061-T6 aluminum main body with Type-III hard coat finish
- Steel components feature durable manganese phosphate finish
- Large clamp for stable attachment
- 1/2 MOA click adjustments calibrated for carbine sight radius

71BU00 | BK | \$79.99



71SS03



71SS04

AR-15 Offset Safety Selector **NEW!**

- Drop-in replacement safety selector for AR platform firearms
- Improves ergonomics and facilitates easier manipulation
- Little to no change in strong hand grip required when returning weapon to safe
- High-quality components and finish
- Both right-handed and ambidextrous versions available

Right Hand | 71SS03 | BK | \$19.99

Ambidextrous | 71SS04 | BK | \$39.99





AR-15 Rifle Quad Rail Forend (Two Piece)

- Replaces handguards with no modifications to the weapon
- Slim profile for comfortable handguard-like feel
- Unique vent hole design helps dissipate heat and reduce weight
- Limited rotation push-button sling swivel attachment points on left and right sides
- Interlocking halves secured with six screws for extra strength and stability

71QF00 | BK | \$204.99 

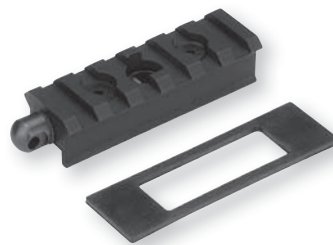

Swivel Stud Picatinny Rail Adapter

- Constructed of rugged 6061 T6 aluminum with Type-III hard-coat anodized finish
- Provides Picatinny rail section for rail-mounted accessories
- Contains side swivel stud for continued use of sling
- Mounts to existing rifle swivel stud

71RA00 | BK | \$31.99 



Offset Flashlight Rail Mount

- Constructed of 6061 T6 aluminum with Type-III hard-coat anodized finish
- For mounting flashlights to Picatinny spec rails
- Offset design for optimal positioning
- Compatible with 1" body flashlights
- Weight: 1.5 oz.

71RM01 | BK | \$34.99 



AR-15 Carbine Quad Rail Forend (Two Piece)

- Replaces handguards with no modifications to the weapon
- Slim profile for comfortable handguard-like feel
- Unique vent hole design helps dissipate heat and reduce weight
- Limited rotation push-button sling swivel attachment points on left and right sides
- Interlocking halves are secured with four screws for extra strength and stability

71QF01 | BK | \$154.99 



AR-15/M16 Same Plane Sight Aperture

- MIL-spec manganese phosphate finish
- Direct replacement for M16A2-style dual aperture sights
- Both large and small apertures are on the same plane
- Compensates for lateral movement on windage screw while switching between apertures
- One zero for both apertures with no point of impact shift
- Large aperture (0.208" I.D.) for quick sight acquisition in close quarters or low light
- Small aperture (0.081" I.D.) for longer, more accurate sighting of distant targets

71SA02 | BK | \$24.99 

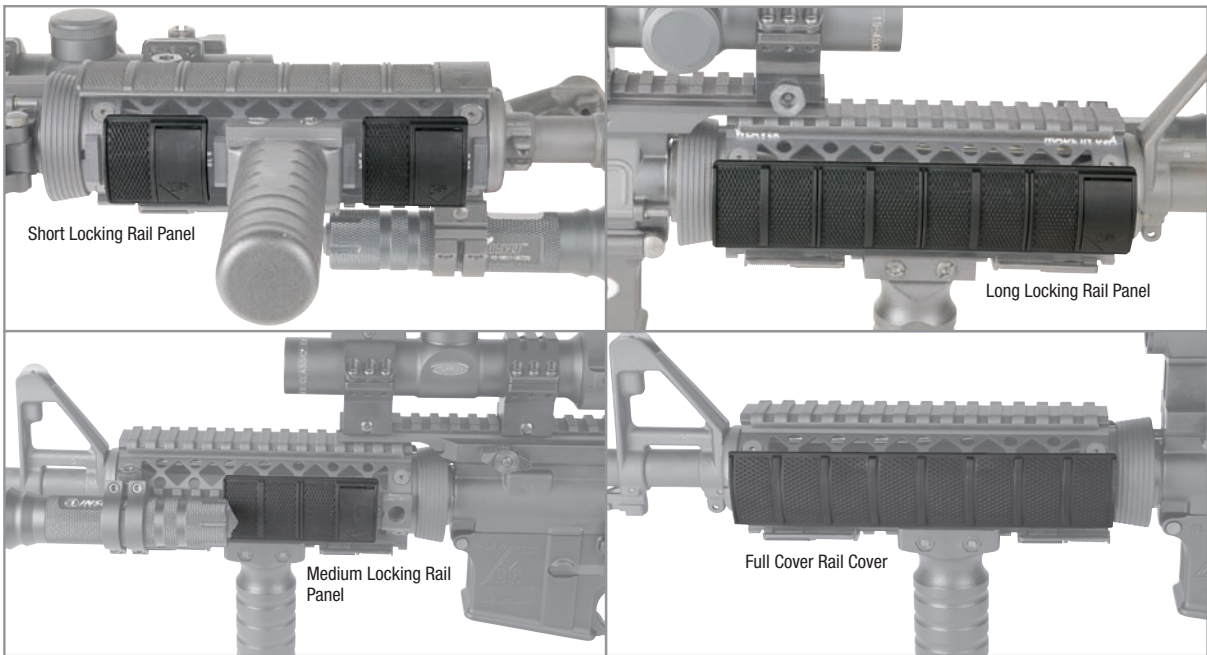

Locking Rail Panels WHILE SUPPLIES LAST

Our Locking Rail Panels protect unused rail areas from damage while providing a gripping surface that shields the operator from weapon heat and sharp rail edges. Made of a tough, ridged polymer and using the patented Rail-Lok™ integral locking mechanism to keep them securely in place, these low-profile rail panels improve feel and weapon control.

- Fits most Picatinny spec rails
- Low-profile, aggressive grip surface for better weapon control
- Short Locking Rail Panel (71RP02) covers 1.6" of rail each and offers coverage for small uncovered rail areas next to mounted accessories
- Medium Locking Rail Panel (71RP01) covers 3.2" of rail and offers 1/2 coverage on an AR-15/M4 Carbine length forend rail.
- Long Locking Rail Panel (71RP00) covers 6.375" of rail and offers full coverage for AR-15/M4 Carbine length forend rails

Short Locking Rail Panel (Set of Two) | 71RP02 | BK, OD, DK | \$18.99

Medium Locking Rail Panel (One) | 71RP01 | BK, OD, DK | \$12.99

Long Locking Rail Panel (One) | 71RP00 | BK, OD, DK | \$12.99



Full Cover Rail Cover

Protect unused rail areas from damage while providing a gripping surface that shields the operator from weapon heat and sharp rail edges with our Full Cover Rail Cover. Made of Santoprene® and designed with a low-profile grip surface for improved weapon control, it clips anywhere on a rail without removing other attachments.

- Fits most Picatinny spec rails
- Can be cut to size for a custom fit
- Checkered texture and rubbery surface for improved weapon control

71RC00 | BK, OD, DK | \$12.99



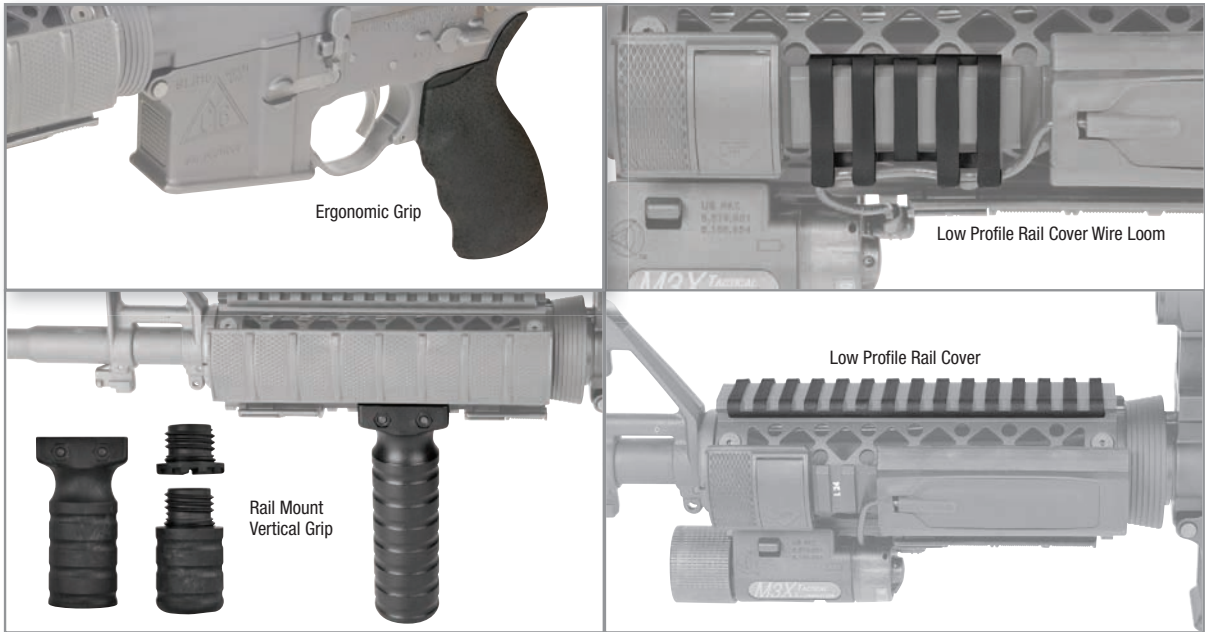

Ergonomic Grip

This ergonomically designed pistol grip with finger grooves is comfortable, prevents fatigue and aids in controlling the weapon even when you wear gloves. The aggressive textured grip surface minimizes slippage and is virtually impervious to oils and solvents used on firearms.

- Fits most AR-15/M16 style rifles
- Subtle finger grooves
- Integral rear upper extension supports web of hand
- Rubber bottom plug with lanyard and storage compartment

71EG00 | BK, OD, DK | \$26.99 

Low Profile Rail Cover Wire Loom

Safely keep electrical wires out of the way with this lightweight, low-profile five-slot cover. It uses an integral wire loom to quickly and reliably secure electrical wires commonly found on remote pressure switches.

- Fits most Picatinny spec rails
- Constructed of Santoprene® for rubbery grip surface
- Low-profile ladder-style cover for rail protection

71RC01 | BK, OD, DK | \$7.99 

Rail Mount Vertical Grip

Enjoy improved weapon control and heat management with our Rail Mount Vertical Grip. Molded of high-performance, fiberglass-reinforced polymer, it incorporates redundant clamp screws for secure, reliable mounting and an adjustable fit to compensate for out-of-spec rails.

- Constructed of fiberglass-reinforced polymer
- Two different caps (included) for custom length
- O-ring sealed compartment for tools, batteries, etc.

71VG00 | BK, OD, DK | \$38.99 

Low Profile Rail Cover

Get complete rail protection with minimal weight with the Low Profile Rail Cover. Constructed of lightweight Santoprene® with a rubbery grip surface, this rail cover delivers improved weapon control and effectively shields the operator from sharp rail edges.

- Fits most Picatinny spec rails
- 18 slots of length can be cut to size for a custom fit
- Low-profile ladder-style cover for rail protection
- Clip onto rails without removing other attachments

71RL00 | BK, OD, DK | \$10.99 

Sling Attachments



Universal Single-Point Sling Adapter



FNP 90 Sling Adapter



Single-Point Sling Adapter



AR-15/M4 STORM Sling™ Adapter



AR-15/M4 Ambi Sling Adapter



Rail Mount Sling Adapter



Shotgun Single-Point Sling Adapter

Universal Single-Point Sling Adapter

- Ambidextrous design
- Firearm hangs flat against body
- Compatible with most conventional sling hooks
- Fits AR/M4/M16 collapsible stocks (not compatible with some Colt rifles)

70SM04 | BK | NSN# 1005-01-5333425 | \$29.99



AR-15/M4 Ambi Sling Adapter

- For use with collapsible stocks
- No buffer tube removal required
- Works with snap hooks, MASH clip, wire loops, 550 cord or sling webbing (up to 1.5" wide)
- Fits MIL-spec or commercial tubes using included spacers

71SA01 | BK | \$27.99



FNP 90 Sling Adapter

- Constructed of heavy-duty nylon webbing with high-impact polymer D-ring
- Designed for quick attachment of single-point sling to rear of a FNP 90
- Compatible with BLACKHAWK!® single-point slings (see page 178 – 184)

70SA01 | BK | \$11.99

Single-Point Sling Adapter

- Constructed of heavy-duty nylon webbing with robust metal D-rings
- Configures any weapon to accept a single-point sling

70SA00 | BK | \$6.99

AR-15/M4 STORM Sling™ Adapter

- For use with AR-15/M4 rifles equipped with collapsible stock
- Provides ambidextrous mounting points for STORM Slings™ (sold separately, see page 178 – 179)
- Simple add-on installation with no modification required
- Fits MIL-spec or commercial tubes

71SA05 | BK | \$27.99



Rail Mount Sling Adapter

- Constructed of 6061 T6 aluminum with matte Type-III hard-coat anodized finish
- Mounting screw threads into steel insert for additional strength
- Works with snap hooks, MASH clip, wire loops, push-button swivels or sling webbing (up to 1.25" wide)
- Limited rotation push button swivel socket prevents twisted slings
- Weight: 1 oz.

71SA00 | BK | \$31.99



Shotgun Single-Point Sling Adapter

- Configures any weapon to accept a single-point sling
- Robust steel construction with durable manganese phosphate finish
- Mounts between receiver and stock
- Provides ambidextrous mounting points
- Compatible with MASH clip, snap hooks and wire loops
- Compatible with STORM Slings™ (sold separately, see page 178 – 179) or other single-point shotgun slings

Remington® 870/1187 | 71SA03 | BK | \$29.99

Mossberg® 500/590/88 | 71SA04 | BK | \$29.99



Metal 1" Heavy-Duty Snap Hooks (Set of Two)

98HM00 | BK | \$15.99



Metal 2" Heavy-Duty Swivel Snap Hooks (Set of Two)

98HM02 | BK | \$7.99



Front Sling Mount for Remington® 1187/870

70SM01 | BK | \$28.99

Twist Lock QR Sling Swivels

- Constructed of quality materials with durable manganese phosphate finish
- Allows operator to quickly attach/detach sling from weapon
- Locking mechanism prevents unintentional release
- Compatible with most push-button swivel mounting points including those featured on Rail Mount Sling Adapter (sold separately, see page 191) or AR-15 Quad Rail Forends (sold separately, see page 188)
- Facilitates use of MASH clip or snap hooks in push-button mounts (71SS02 only)
- Twist Lock patent # 7,654,027



Twist Lock QR Sling Swivel 1.25" | 71SS01 | BK | \$18.99 

Twist Lock Angular QR Sling Swivel | 71SS02 | BK | \$19.99 

Heavy Duty Push Button Sling Swivel

- Constructed of quality materials with durable manganese phosphate finish
- Allows operator to quickly attach/detach sling from the weapon
- Compatible with most push-button swivel mounting points including those featured on Rail Mount Sling Adapter (sold separately, see page 191) or AR-15 Quad Rail Forends (sold separately, see page 188)



71SS00 | BK | \$16.99 

Constructed of premium steel, our LOK-DOWN™ sling swivels (see below) are precision-machined and assembled to exacting tolerances for maximum performance and quiet carry. A positive locking mechanism keeps the swivel attached to the gun until you remove it.

Standard Swivels



Action Machine Screw Type

- Includes LOK-DOWN™ Swivel Set (see right)
- Machine screw forend base
- Wood screw rear base

1" Blued | 70SW01 | BK | \$10.99
1.25" Blued | 70SW15 | BK | \$11.99



Bolt Action Wood Screw Type

- Includes LOK-DOWN™ Swivel Set (see right)
- Wood screw forend base and rear base

1" Blued | 70SW04 | BK | \$10.99
1.25" Blued | 70SW21 | BK | \$11.99



LOK-DOWN™ Swivel Set

- Includes two detachable swivels
- Positive locking mechanism

1" Blued | 70SW07 | BK | \$9.99
1.25" Blued | 70SW08 | BK | \$9.99
1" Nickel | 70SW02 | BK | \$11.99

Shotgun Swivels 



Remington® 870 Mag Cap Swivel Set



Remington® 1100 Mag Cap Swivel Set



Mossberg® 590/835 Mag Cap Swivel Set
Winchester® 1200/1300 Mag Cap Swivel Set



Mossberg® 500 Swivel Set



Pump and Semi-Auto Shotgun Swivel Set (Stud Type)



Pump and Semi-Auto Shotgun Swivel Set (Collar Type)

Remington® 870 Mag Cap Swivel Set

- Includes LOK-DOWN™ Swivel Set (see page 192)
- Includes replacement cap for internal magazine tube ratchet types
- Wood screw rear base

1" Blued (Remington® 870 Youth) | 70SW11 | BK | \$31.99

1" Blued (Remington® 870 and 870 Express) | 70SW12 | BK | \$31.99

Remington® 1100 Mag Cap Swivel Set

- Replacement magazine cap with swivel base
- 0.75" wood screw buttstock swivel base

1" Blued (12 Gauge) | 70SW27 | BK | \$31.99

1" Blued (20 Gauge) | 70SW28 | BK | \$31.99

Mossberg® 590/835 Mag Cap Swivel Set

- Includes replacement magazine cap with swivel base
- 0.75" wood screw buttstock swivel base

1" Blued (12 Gauge) | 70SW29 | BK | \$31.99

Winchester® 1200/1300 Mag Cap Swivel Set

- Replacement magazine cap with swivel base
- 0.75" wood screw buttstock swivel base

1" Blued (12 Gauge) | 70SW30 | BK | \$31.99

Mossberg® 500 Swivel Set

- Includes LOK-DOWN™ Swivel Set (see page 192)
- Includes replacement take down screw with swivel base
- Wood screw rear base

1" Blued | 70SW13 | BK | \$31.99

Pump and Semi-Auto Shotgun Swivel Set (Stud Type)

- Includes special adapter for Beretta® 390 magazine cap (for most pump and auto magazine caps)
- Mounts on most pumps and autos except Browning® 2000, Winchester® 1400, Ithaca 37, Savage® 30, Sears 21 or Stevens pumps
- Wood screw buttstock swivel base

1" Blued | 70SW20 | BK | \$16.99

Pump and Semi-Auto Shotgun Swivel Set (Collar Type)

- Mounts on most pumps and autos except Browning® 2000, Winchester® 1400, Ithaca 37, Savage® 30, Sears 21 or Stevens pumps
- Cap modification required
- Does not work on gas-operated recoil shotguns

1" Blued | 70SW26 | BK | \$13.99

Specialty Swivels



Push Button Detachable



Remington® Guns 760 and 7600 (1969 to Present)



Split Band Tube Magazine Swivels

Push Button Detachable

- Flush-mount front and rear bases for stud-free profile with sling and swivels removed
- Bases glue in place (no screws required)

1" Blued | 70SW16 | BK | \$18.99

Ruger® Auto and Single Shot Carbinés

- Includes LOK-DOWN™ Swivel Set (see page 192)
- Forend adapter fits barrel band on Ruger® 10/22, .44 magnum carbine, model 44 carbine and no. 3 carbinés
- Optional wood screw forend base for guns with no bands
- Wood screw rear base

1" Blued | 70SW09 | BK | \$14.99

1" Nickel | 70SW10 | BK | \$16.99

Remington® Guns 742 ADL

- Adapter base replaces factory forend bolt on standard or ADL models only (will not fit 742 BDL)

1" Blued | 70SW18 | BK | \$16.99

Remington® Guns 760 and 7600 (1968 and Older)

- Adapter bolt swivel base replaces factory forend bolt without dismantling

1" Blued | 70SW19 | BK | \$16.99



Ruger® Auto and Single Shot Carbinés



Full Band Magazine Tube Swivel Set



Magnum Split Band Swivel Set

Remington® 7400 and Model Four Autoloader

- Includes LOK-DOWN™ Swivel Set (see page 192)
- Forend adapter bolt base
- Wood screw rear base

1" Blued | 70SW03 | BK | \$15.99

Remington® Guns 760 and 7600 (1969 to Present)

- Fits Remington® model 7600, 760s and six pump actions 740, 742, other .22 and centerfires with .645" to .660" diameter barrels

1" Blued | 70SW24 | BK | \$15.99

Full Band Magazine Tube Swivel Set

- Fits magazine tube diameters .645" – .660" for Winchester® and Marlin® centerfire lever actions

1" Blued | 70SW22 | BK | \$14.99

.22 Cal. Tube Magazine Swivels

- Standard full-band mounts on most .22 tube diameters .430" – .445" rifles except Winchester® 94/22M.U.S.

1" Blued | 70SW23 | BK | \$16.99



Remington® Guns 742 ADL
Remington® Guns 760 and 7600 (1968 and Older)



Remington® 7400 and Model Four Autoloader



Browning® BLR Special Purpose Swivel Set



.22 Cal. Tube Magazine Swivels

Split Band Tube Magazine Swivels

- Magnum band fits tube magazines .420" and .470" diameter without dismantling gun
- Detachable 1" swivel

1" Blued | 70SW17 | BK | \$13.99

Magnum Split Band Swivel Set

- Includes LOK-DOWN™ Swivel Set (see page 192)
- Mounts on magazine tubes .630" to .675" diameter
- Mounts on barrels of some Ruger® and Browning® models
- Mounts on some barrels of .410 shotguns

1" Blued | 70SW05 | BK | \$14.99

1.25" Blued | 70SW06 | BK | \$14.99

Browning® BLR Special Purpose Swivel Set

- Replaces factory forend spacer without altering or dismantling (does not fit BLR Lightning)

1" Blued | 70SW25 | BK | \$13.99

Identification Panel Base

- Hook & loop panel for attaching ID panels to S.T.R.I.K.E.® webbing
- Mounts with Speed Clips™ (two included)
- Dimensions: 2.5"H x 5.5"W

38CL42 | BK, CT, OD, FG | \$9.99



[Learn more about our patented Speed Clip™ system on page 214!](#)

Red Cross Medic ID Patch

- Smooth embroidery (not printed)
- Hook backing with loop panel included
- Can be sewn to clothing or gear
- Dimensions: 2.5"H x 2.5"W

90RC00 | BK, CT, OD, FG | \$6.99



American Flag Patch

- Embroidered with matching border
- Hook & loop panel for quick on/off capability
- Dimensions: 2"H x 3"W

\$6.99



90SAFV-R
Reversed
Subdued Olive Drab



90RWBV-R
Reversed
Full Color

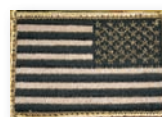

90DTFV-R
Reversed
Subdued Coyote Tan



90SAFV
Standard
Subdued Olive Drab



90RWBV
Standard
Full Color

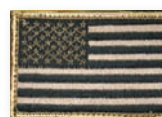

90DTFV
Standard
Subdued Coyote Tan

Identification Panels

- Smooth embroidery (not printed)
- Easily mounts to S.T.R.I.K.E.® webbing Identification Panel Base (sold separately, see top of page)
- Hook backing with loop panel included
- Can be sewn to clothing or gear
- Custom lettering on panels upon request (500 piece minimum; call customer service at 800.694.5263)
- Dimensions: 2.5"H x 5.5"W

\$9.99

***WHILE SUPPLIES LAST**



90IN03WB 90IN03WG 90IN03GB 90IN03BG



90IN04WB 90IN04WG 90IN04GB 90IN04BG



90IN07WB* 90IN07WG* 90IN07GB* 90IN07BG*



90IN01WG* 90IN01GB* 90IN01BG*



90IN02WB 90IN02WG* 90IN02GB 90IN02BG 90IN05WB



90IN05WG 90IN05GB 90IN05BG

3700, 3800 and 3900 Series

We understand that no two missions are the same and that your modular gear preferences may change on a daily basis. That's why we offer a wide selection of quality nylon pouches to accommodate your varied yet specific needs. Choose from our MOLLE 3700 Series, Speed Clip™ 3800 Series or USA-made MOLLE 3900 Series pouches.

Available Colors:

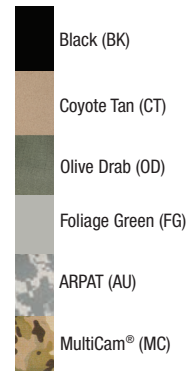

MOLLE 3700 Series

Mount our 3700 Series pouches to any S.T.R.I.K.E.® or PALS/MOLLE platform by weaving the integral straps on the back of the pouch in and out of the platform webbing. Our MOLLE 3700 Series pouches are constructed of 500 denier nylon (solid colors) or 500 denier CORDURA® nylon (MultiCam®).



Speed Clips™ 3800 Series

Our innovative Speed Clips are the quickest, strongest and most convenient modular attachment system on the market—allowing you to quickly mount, disconnect and rearrange your gear with ease. Our Speed Clip™ 3800 Series pouches are constructed of 1000 denier nylon (solid colors) or 1000 denier CORDURA® nylon (MultiCam®). See Speed Clips on page 214.



USA MOLLE 3900 Series

In support of the Berry Amendment Compliant requests from US Fighting Forces, we now offer a complete line of pouches made in our Meridian, Idaho facility. Our USA MOLLE 3900 Series pouches are constructed of 500 denier CORDURA® nylon.

Hybrid Design

Our hybrid pouches are designed for extreme versatility, allowing you to mount the pouch to S.T.R.I.K.E.® or PALS/MOLLE platforms via our Speed Clips™ or to a belt using either ALICE Clips or our sturdy BTS™ belt loop attachment system. See all hybrid pouches on page 212 – 214.

ALICE Attachment



Belt Attachment



Speed Clip™ Attachment





Single Pistol Mag Pouch

MOLLE 3700 Series | 37CL06 | BK, CT, OD, MC | \$12.99 (MC = \$14.99)
 Speed Clip™ 3800 Series | 38CL06 | BK, CT, OD, AU | \$13.99
 USA MOLLE 3900 Series | 39CL06 -USA | BK, CT, MC | \$21.99 (MC = \$22.99)



Double Pistol Mag Pouch

MOLLE 3700 Series | 37CL09 | BK, CT, OD, MC | \$20.99 (MC = \$22.99)
 Speed Clip™ 3800 Series | 38CL09 | BK, CT, OD, AU | \$21.99
 USA MOLLE 3900 Series | 39CL09 -USA | BK, CT, MC | \$30.99 (MC = \$34.99)



Cuff/Mag/Light Pouch

MOLLE 3700 Series | 37CL55 | BK, CT, OD, MC | \$21.99 (MC = \$25.99)
 Speed Clip™ 3800 Series | 38CL55 | BK, CT, OD, AU | \$22.99 **WHILE SUPPLIES LAST (AU)**
 USA MOLLE 3900 Series | 39CL55 -USA | BK, CT, MC | \$33.99 (MC = \$35.99)



M4/M16 Single Mag Pouch (Holds 1)

MOLLE 3700 Series | 37CL68 | BK, CT, OD, MC | \$19.99 (MC = \$21.99)
 Speed Clip™ 3800 Series | 38CL68 | BK, CT, OD, AU | \$20.99
 USA MOLLE 3900 Series | 39CL68 -USA | BK, CT, MC | \$21.99 (MC = \$22.99)



M4/M16 Single Mag Pouch (Holds 2)

MOLLE 3700 Series | 37CL02 | BK, CT, OD, MC | \$21.99 (MC = \$24.99)
 Speed Clip™ 3800 Series | 38CL02 | BK, CT, OD, AU | \$22.99
 USA MOLLE 3900 Series | 39CL02 -USA | BK, CT, MC | \$32.99 (MC = \$38.99)



M4/M16 Double Mag Pouch (Holds 4)

MOLLE 3700 Series | 37CL03 | BK, CT, OD, MC | \$38.99 (MC = \$44.99)
 Speed Clip™ 3800 Series | 38CL03 | BK, CT, OD, AU | \$39.99
 USA MOLLE 3900 Series | 39CL03 -USA | BK, CT, MC | \$57.99 (MC = \$6.799)



**AK47 Double Mag Pouch
(Holds 4)**

MOLLE 3700 Series | 37CL88 | BK, CT, OD, MC | \$48.99 (MC = \$52.99)
 Speed Clip™ 3800 Series | 38CL84 | BK, CT, OD, AU | \$49.99 **WHILE SUPPLIES LAST (AU)**
 USA MOLLE 3900 Series | 39CL88 -USA | BK, CT, MC | \$52.99 (MC = \$54.99)



**M4/M16 Triple Mag Pouch
(Holds 6)**

MOLLE 3700 Series | 37CL04 | BK, CT, OD, MC | \$46.99 (MC = \$55.99)
 Speed Clip™ 3800 Series | 38CL04 | BK, CT, OD, AU | NSN# 8465-01-517-6324 (BK) | \$47.99
 USA MOLLE 3900 Series | 39CL04 -USA | BK, CT, MC | \$73.99 (\$88.99)



18-Round Shotgun Pouch

MOLLE 3700 Series | 37CL51 | BK, CT, OD, MC | \$32.99 (MC = \$34.99)
 Speed Clip™ 3800 Series | 38CL51 | BK, CT, OD, AU | \$33.99
 USA MOLLE 3900 Series | 39CL51 -USA | BK, CT, MC | \$35.99 (MC = \$37.99)



**M4/M16 Staggered Mag Pouch
(Holds 2)**

MOLLE 3700 Series | 37CL65 | BK, CT, OD, MC | \$28.99 (MC = \$31.99)
 Speed Clip™ 3800 Series | 38CL65 | BK, CT, OD | NSN# 8465-01-533-3088 (BK), NSN# 8465-01-533-3007 (CT), NSN# 8465-01-533-3006 (OD) | \$29.99
 USA MOLLE 3900 Series | 39CL65 -USA | BK, CT, MC | \$35.99 (MC = \$38.99)



Smoke Grenade Single Pouch

MOLLE 3700 Series | 37CL14 | BK, CT, OD, MC | \$19.99 (MC = \$21.99)
 Speed Clip™ 3800 Series | 38CL14 | BK, CT, OD, AU | \$20.99 **WHILE SUPPLIES LAST (AU)**
 USA MOLLE 3900 Series | 39CL14 -USA | BK, CT, MC | \$30.99 (MC = \$31.99)



Flashbang Pouch

MOLLE 3700 Series | 37CL54 | BK, CT, OD, MC | \$18.99 (MC = \$20.99)
 Speed Clip™ 3800 Series | 38CL54 | BK, CT, AU | \$19.99 **WHILE SUPPLIES LAST (AU)**
 USA MOLLE 3900 Series | 39CL54 -USA | BK, CT, MC | \$20.99 (MC = \$22.99)



Shown with pouches mounted

Horizontal Platform **WHILE SUPPLIES LAST**

- MOLLE 3700 Series attachment (37CL75)
- Speed Clip™ 3800 Series attachment (38CL75)
- Platform for mounting pouches horizontally (pouches not included)
- Dimensions: 7”L x 7”W

MOLLE 3700 Series | 37CL75 | AU | \$26.99
 Speed Clip™ 3800 Series | 38CL75 | AU | \$26.99



ASIP Radio Pack/Pouch

MOLLE 3700 Series | 37CL99 IBK, CT, OD, MC | \$78.99 (MC = \$89.99)
 Speed Clip™ 3800 Series | 38CL99 | AU | \$79.99 **WHILE SUPPLIES LAST**
 USA MOLLE 3900 Series | 39CL99 -USA | BK, CT, MC | \$83.99 (MC = \$89.99)



Radio Pouch MBITR

MOLLE 3700 Series | 37CL20 | BK, CT, OD, MC | \$40.99 (MC = \$42.99)
 Speed Clip™ 3800 Series | 38CL20 | BK, CT, OD, AU | \$41.99
 USA MOLLE 3900 Series | 39CL20 -USA | BK, CT, MC | \$49.99



Small Radio/GPS Pouch

MOLLE 3700 Series | 37CL35 | BK, CT, OD, MC | \$24.99 (MC = \$26.99)
 Speed Clip™ 3800 Series | 38CL35 | BK, CT, OD, AU | \$25.99
 USA MOLLE 3900 Series | 39CL35 -USA | BK, CT, MC | \$30.99 (MC = \$31.99)



PRC-112 Radio Pouch

MOLLE 3700 Series | 37CL26 | BK, CT, OD, MC | \$31.99 (MC = \$33.99)
 Speed Clip™ 3800 Series | 38CL26 | BK, CT, AU | NSN# 8465-01-517-6328 (BK), NSN# 8465-01-554-2843 (CT) | \$32.99
 USA MOLLE 3900 Series | 39CL26 -USA | BK, CT, MC | \$36.99 (MC = \$38.99)



Upright GP Pouch

MOLLE 3700 Series | 37CL52 | BK, CT, OD, MC | \$36.99 (MC = \$39.99)
 Speed Clip™ 3800 Series | 38CL52 | BK, CT, OD, FG, AU | \$37.99 **WHILE SUPPLIES LAST (FG, AU)**
 USA MOLLE 3900 Series | 39CL52 -USA | BK, CT, MC | \$41.99 (MC = \$51.99)



Nalgene® Bottle Utility Pouch

MOLLE 3700 Series | 37CL70 | BK, CT, OD, MC | \$37.99 (MC = \$40.99)
 Speed Clip™ 3800 Series | 38CL70 | BK, CT, OD, AU | \$38.99
 USA MOLLE 3900 Series | 39CL70 -USA | BK, CT, MC | \$39.99 (MC = \$41.99)
Note: Accommodates BLACKHAWK!® Nalgene® Bottle (sold separately, see page 2) or other 32-oz. bottles.



Traditional



Short/Wide

Hydration Carrier

Traditional:

- MOLLE 3700 (37CL37) or Seed Clip™ 3800 Series attachment (38CL37)
- Accommodates 100-oz. hydration reservoir (sold separately, see page 80)
- S.T.R.I.K.E.® webbing for attaching pouches or accessories

Short/Wide:

- Speed Clip™ 3800 Series attachment (38CL88)
- Accommodates short/wide 100-oz. hydration reservoir (sold separately)
- S.T.R.I.K.E.® webbing for attaching pouches or accessories
- Low-profile, more compact design to fit in vehicles

Traditional (MOLLE 3700 Series) | 37CL37 | OD | \$43.99 **WHILE SUPPLIES LAST**
 Traditional (Speed Clip™ 3800 Series) | 38CL37 | BK, CT, OD | \$43.99
 Short/Wide | 38CL88 | CT, OD, AU | \$47.99



Medical Pouch

MOLLE 3700 Series | 37CL18 | BK, CT, OD, MC | \$34.99 (MC = \$37.99)
 Speed Clip™ 3800 Series | 38CL18 | BK, CT, OD, AU | \$35.99
 USA MOLLE 3900 Series | 39CL18 -USA | BK, CT, MC | \$42.99 (MC = \$43.99)



Large Utility Pouch with Zipper

MOLLE 3700 Series | 37CL60 | BK, CT, OD, MC | \$37.99 (MC = \$40.99)
 Speed Clip™ 3800 Series | 38CL60 | BK, CT, OD, FG, AU | NSN# 8465-01-553-7869 (CT) | \$38.99 **WHILE SUPPLIES LAST (FG)**
 USA MOLLE 3900 Series | 39CL60 -USA | BK, CT, MC | \$41.99 (MC = \$44.99)



Utility Pouch

MOLLE 3700 Series | 37CL21 | BK, CT, OD, MC | \$27.99 (MC = \$30.99)
 Speed Clip™ 3800 Series | 38CL21 | BK, CT, OD, FG, AU | NSN# 8465-01-517-2976 (BK), NSN# 8465-01-554-2842 (CT), NSN# 8465-01-518-0915 (OD) | \$28.99 **WHILE SUPPLIES LAST (FG)**
 USA MOLLE 3900 Series | 39CL21 -USA | BK, CT, MC | \$35.99 (MC = \$37.99)



Medium Utility Pouch

MOLLE 3700 Series | 37CL46 | BK, CT, OD, MC | \$36.99 (MC = \$40.99)
 Speed Clip™ 3800 Series | 38CL46 | BK, CT, OD, AU | NSN# 8645-01-560-4129 (BK), NSN# 8645-01-560-1831 (CT) | \$37.99
 USA MOLLE 3900 Series | 39CL46 -USA | BK, CT, MC | \$38.99 (MC = \$39.99)



Small Utility Pouch

MOLLE 3700 Series | 37CL45 | BK, CT, OD, MC | \$32.99 (MC = \$35.99)
 Speed Clip™ 3800 Series | 38CL45 | BK, CT, AU | \$33.99 **WHILE SUPPLIES LAST (AU)**
 USA MOLLE 3900 Series | 39CL45 -USA | BK, CT, MC | \$34.99 (MC = \$35.99)



Admin/Compass/Flashlight Pouch

MOLLE 3700 Series | 37CL32 | BK, CT, OD, MC | \$26.99 (MC = \$29.99)
 Speed Clip™ 3800 Series | 38CL32 | BK, CT, OD, AU | \$27.99
 USA MOLLE 3900 Series | 39CL32 -USA | BK, CT, MC | \$42.99 (MC = \$45.99)



Pro Marksman Pouch

- Securely holds 20 rounds of .308 ammunition
- Elastic band protects projectile tips (pen/pencil holder included)
- Side flaps have clear windows so range data can be displayed when opened
- Use with any S.T.R.I.K.E.® or PALS/MOLLE platform (vest, carrier or backpack)
- Secured with silent, adjustable side-release buckles

MOLLE 3700 Series | 37CL87 | BK, CT, OD, MC | \$38.99 (MC = \$41.99)
 Speed Clip™ 3800 Series | 38CL86 | CT, OD | \$39.99
 USA MOLLE 3900 Series | 39CL87 -USA | BK, CT, MC | \$48.99 (MC = \$57.99)

MOLLE 3700 Series



SR25/M14 Single Mag Pouch **NEW!**

- MOLLE 3700 Series attachment
- Holds one SR25/M14 or similar 20-round 7.62x51 magazines
- Open top with bungee retention
- Grommets for drainage
- S.T.R.I.K.E.® webbing on front for attaching additional items
- Dimensions: 4.3"L x 3.14"W x 1.37"D
- Weight: 0.17 lbs.

37CL115 | BK, CT, OD, MC | \$20.99
 (MC = \$22.99)



Tier Stacked M16/M4/P Mag Pouch **NEW!**

- MOLLE 3700 Series attachment
- Holds two M16 magazines
- Stair-stepped configuration for easy access
- Open top with bungee retention
- Grommets for drainage
- S.T.R.I.K.E.® webbing on front for attaching additional items
- Dimensions: 5.51"L x 3.14"W x 19.6"D
- Weight: 0.24 lbs.

37CL118 | BK, CT, OD, MC | \$24.99
 (MC = \$26.99)



Tier Stacked SR25/M14 Mag Pouch **NEW!**

- MOLLE 3700 Series attachment
- Holds two SR25/M14 or similar 20-round 7.62x51 magazines
- Stair-stepped configuration for easy access
- Open top with bungee retention
- Grommets for drainage
- S.T.R.I.K.E.® webbing on front for attaching additional items
- Dimensions: 5.51"L x 3.46"W x 19.6"D
- Weight: 0.24 lbs.

37CL119 | BK, CT, OD, MC | \$25.99
 (MC = \$27.99)



SureFire® Mag Pouch (60 Round) **NEW!**

- MOLLE 3700 Series attachment
- Holds 60-round SureFire® magazine
- Adjustable lid
- Grommets for drainage
- Dimensions: 7.48"L x 4.13"W x 0.37"D
- Weight: 0.33 lbs.

37CL122 | BK, CT, OD, MC | \$28.99
 (MC = \$33.99)



SureFire® Mag Pouch (100 Round) **NEW!**

- MOLLE 3700 Series attachment
- Holds 100-round SureFire® magazine
- Adjustable lid
- Grommets for drainage
- Dimensions: 11.43"L x 0.33"W x 1.57"D
- Weight: 0.64 lbs.

37CL121 | BK, CT, OD, MC | \$39.99
 (MC = \$51.99)



Admin/Flashlight Pouch **NEW!**

- MOLLE 3700 Series attachment
- Loop panel and S.T.R.I.K.E.® webbing on front for identification and IR markers
- Large main compartment and smaller compartment with elastic loops for securing miscellaneous items
- Flashlight pocket with adjustable lid fits tactical handheld lights
- Grommets for drainage and attaching lanyards/dummy cords
- Dimensions: 7.06"L x 7.48"W x 0.98"D
- Weight: 0.38 lbs.

37CL114 | BK, CT, OD, MC | \$29.99
 (MC = \$33.99)



S.T.R.I.K.E.® Roll-Up Dump Pouch NEW!

- MOLLE 3700 Series attachment
- Internal elastic loops for light sticks, shotgun shells, etc.
- Shock cord cinches tight to retain contents
- Stiffener in opening of main compartment holds pouch open for easy access
- Grommets for drainage
- S.T.R.I.K.E.® webbing on front for attaching additional items
- Dimensions: 10"L x 8.66"W x 3.93"D
- Weight: 0.5 lbs.

37CL117 | BK, CT, OD, MC | \$39.99
(MC = \$44.99)



Pop-Up Tourniquet Pouch NEW!

- MOLLE 3700 Series attachment
- One-handed operation with quick access to tourniquet (not included)
- Internal 1.5" strap wraps under tourniquet and through lid for easy tourniquet removal
- Dimensions: 4.75"L x 2.25"W x 2.25"D
- Weight: 0.10 lbs.

37CL107 | BK, CT, OD, MC | \$21.99
(MC = \$23.99)



Compact Medical Pouch NEW!

- MOLLE 3700 Series attachment
- Removable internal panel with multiple loops to organize and retain medical supplies
- Encased foam handle for quick one-handed operation
- Red zipper pulls for medical content identification
- Grommets for drainage
- 2.5" x 2.5" loop panel for patch attachment
- Can be configured for belt wear
- Dimensions: 6.75"L x 4.25"W x 2"D
- Weight: 0.40 lbs.

37CL124 | BK, CT, OD, MC | \$34.99
(MC = \$40.99)



Quick Release Med Pouch NEW!

- MOLLE 3700 Series attachment
- Removable medical pouch disconnects quickly from platform
- Side-release buckle for additional security
- Red handle and zipper pulls for medical content identification
- Grommets for drainage
- Internal pocket and elastic straps for stowing critical supplies
- 2.5" x 2.5" loop on front for patch attachment
- Can be configured for belt wear
- Dimensions: 7"L x 5.5"W x 3"D
- Weight: 0.50 lbs.

37CL116 | BK, CT, OD, MC | \$39.99
(MC = \$44.99)



Watch Holder

- MOLLE 3700 Series attachment
- Holds watch or wrist compass securely for easy access
- Dimensions: 4"L x 1.5"W

37CL79 | BK, CT, FG | \$9.99



Pouch not included

S.T.R.I.K.E.® Magazine Shoulder Platform **NEW!**

- MOLLE 3700 Series attachment
- Low-profile modular platform for building E&E, active shooter or other bug-out style rig
- Minimalist bandoleer-style platform
- S.T.R.I.K.E.® webbing for attaching pouches or accessories
- Perfect size for mounting two SureFire® 100-round magazine pouches (sold separately, see page 201)
- Dimensions: 12.6”L x 6.69”W x 0.78”D
- Weight: 0.53 lbs.

37CL123 | BK, CT, OD, MC | \$36.99 (BK, CT), \$43.99 (OD, MC)



Folding Dump Pouch

- Hook & loop attachment
- Belt-mounted folding/roll-up dump pouch
- Low-profile design for use as magazine dump pouch, evidence bag, flex cuff pouch, etc.

37CL77 | CT | \$24.99

Did you know? S.T.R.I.K.E.® webbing—our version of popular PALS/MOLLE webbing—is used to attach smaller pouches or accessories onto load-bearing platforms.

Speed Clip™ 3800 Series



Single Pistol Mag Pouch with TalonFlex™

- Speed Clip™ 3800 Series attachment
- TalonFlex™ inserts hold magazine tightly but allow for instant reloads and silent carry
- Holds one pistol magazine

38CL08 | BK, CT, OD, AU | \$16.99



Double Pistol Mag Pouch with TalonFlex™

- Speed Clip™ 3800 Series attachment
- TalonFlex™ inserts hold magazines tightly but allow for instant reloads and silent carry
- Holds two pistol magazines

38CL10 | BK, CT, OD, AU | NSN# 8465-01-517-7106 (BK), NSN# 8465-01-449-6466 (CT) | \$27.99



MP-5 Pouch

- Speed Clip™ 3800 Series attachment
- Holds three magazines
- Reversed-opening lids
- Grommets for drainage

38CL106 | BK, CT | \$34.99



Coupled Magazine Pouch (Double) WHILE SUPPLIES LAST

- Speed Clip™ 3800 Series attachment
- Holds two coupled 30-round M4/M16 magazines (38CL102)
- Holds two .308 or four AK-47 magazines (38CL112)

38CL102 -GSA | CT, OD, AU | \$45.99
 38CL112 | CT, AU | \$45.99



Coupled Magazine Pouch (Triple) WHILE SUPPLIES LAST

- Speed Clip™ 3800 Series attachment
- Holds three coupled 30-round M4/M16 magazines (38CL103)
- Holds three .308 or six AK-47 magazines (38CL113)

38CL103 -GSA | CT | \$59.99
 38CL113 | CT, OD, AU | \$59.99



Cutaway Vest Ammo Pockets WHILE SUPPLIES LAST

- Speed Clip™ 3800 Series attachment
- Non-slip securing tabs
- Small model (38CL104) fits two M4/M16 magazines
- Large model (38CL105) fits three M4/M16 magazines

38CL104 | BK, CT, OD, AU | \$29.99
 38CL105 | CT, OD, AU | \$35.99



M4 Double Magazine for 20-Round Magazines

- Speed Clip™ 3800 Series attachment
- Adjustable lid design
- Holds four M4/M16 20-round magazines

38CL87 | BK | \$34.99



AK/M4 Single Mag Pouch

- Speed Clip™ 3800 Series attachment
- Holds two magazines
- Adjustable lid design

38CL85 | BK, CT, MC | \$34.99 (MC = \$37.99)



Shotgun Ammo Pouch WHILE SUPPLIES LAST

- Speed Clip™ 3800 Series attachment
- Holds 12 rounds

38CL30 | BK, AU | \$30.99



Double M14 Pouch with Divider
• Speed Clip™ 3800 Series attachment

38CL58 | BK, CT, OD, AU | \$47.99



Double G36/Triple M16 Pouch
WHILE SUPPLIES LAST
• Speed Clip™ 3800 Series attachment

38CL57 | BK | \$49.99



Folding Ammo Pouch
WHILE SUPPLIES LAST

- Speed Clip™ 3800 Series attachment
- Holds 20 rounds of .308 ammunition in individual elastic loops
- Use with any S.T.R.I.K.E.® or PALS/MOLLE platform (vest, carrier or backpack)
- Secured with silent, adjustable side-release buckles

38CL72 | AU | \$34.99



SAW Pouch
WHILE SUPPLIES LAST
• Speed Clip™ 3800 Series attachment
• 200-round capacity
• Dimensions: 8"L x 7.5"W x 3"D

38CL76 | CT, AU | \$49.99



SAW Pouch
• Speed Clip™ 3800 Series attachment
• 200-round capacity
• Removable elastic internal lid for easy access to shells
• Dimensions: 7"L x 5.75"W x 3"D

38CL28 | BK, CT, OD | \$52.99



M-240 Ammo Pouch 100-Round
WHILE SUPPLIES LAST
• Speed Clip™ 3800 Series attachment
• 200-round capacity
• Detachable top
• Dimensions: 7"L x 6"W x 3"D

38CL27 | CT, OD, AU | \$54.99



Frag Grenade Pouch (Single)

- Speed Clip™ 3800 Series attachment
- Holds one frag grenade

38CL12 | BK, CT, OD | \$19.99 **WHILE SUPPLIES LAST (BK)**



Frag Grenade Pouch (Double)

WHILE SUPPLIES LAST

- Speed Clip™ 3800 Series attachment
- Holds two frag grenades

38CL13 | CT, OD | \$36.99



Pop-Up Frag Pouch (Triple)

WHILE SUPPLIES LAST

- Speed Clip™ 3800 Series attachment
- Internal 1.5" strap wraps under grenade and through lid for easy grenade removal
- Holds three frag grenades

38CL69 | CT, AU | \$47.99



40mm Grenade Pouch (Holds Two) WHILE SUPPLIES LAST

- Speed Clip™ 3800 Series attachment

38CL22 | BK, OD, AU | \$25.99



40mm Grenade Pouch (Holds Three) WHILE SUPPLIES LAST

- Speed Clip™ 3800 Series attachment
- Adjustable lids

38CL23 | BK, OD, AU | NSN# 8465-01-517-6325 (BK) | \$37.99



40mm Grenade Pouch (Holds Six) WHILE SUPPLIES LAST

- Speed Clip™ 3800 Series attachment
- Mesh bottom
- Dimensions: 6.5"L x 6"W x 3"D

38CL59 | BK, CT, OD | \$34.99



Single Pop Flare Pouch

WHILE SUPPLIES LAST

- Speed Clip™ 3800 Series attachment
- Side-release buckle closure

38CL15 | BK, OD, AU | \$22.99



GPS Pouch

- Speed Clip™ 3800 Series attachment
- Can also be belt-mounted with hook & loop on belt
- Designed to hold digital cameras and GPS units like Garmin eTrex®
- Padded for device protection
- Dimensions: 3.5"L x 2"W x 1.25"D (internal)

38CL90 | BK, CT, AU | \$24.99 **WHILE SUPPLIES LAST (AU)**



Pop-Up Tourniquet Pouch

- Speed Clip™ 3800 Series attachment
- Quick access to tourniquet (not included)
- Internal 1.5" strap wraps under tourniquet and through lid for easy tourniquet removal

38CL107 | BK, CT | \$22.99



1-qt. Canteen Pouch

- Speed Clip™ 3800 Series attachment
- Includes two #5 Speed Clips™ (see page 214)
- Small internal pocket for purification tablets, etc.
- Accommodates canteen cups and standard 1-qt. canteens like our BLACKHAWK!® Nalgene® Canteen (sold separately, see page 2)
- Can also be used as utility pouch for other items

38CL111 | CT, OD | \$40.99



NVG Pouch **WHILE SUPPLIES LAST**

- Speed Clip™ 3800 Series attachment
- Designed to hold night-vision goggles securely
- Dimensions: 6"L x 5.75"W x 2.75"D

38CL53 | CT, OD, AU | \$32.99



Compass/Strobe Pouch

- Speed Clip™ 3800 Series attachment
- Dimensions: 4.75"L x 3"W x 1.75"D

38CL38 | CT, OD | \$17.99 **WHILE SUPPLIES LAST (OD)**



Gas Mask Carrier

- Speed Clip™ 3800 Series attachment
- Dimensions: 9"L x 6"W x 3.5"D

38CL19 | BK, CT, OD, AU | \$39.99



Binocular Pouch

- Speed Clip™ 3800 Series attachment
- Smooth protective lining and fully padded throughout
- External zippered storage pocket
- Dimensions: 8"L x 7"W x 3"D

60BN02 | BK, CT, OD | \$44.99 **WHILE SUPPLIES LAST (AU)**

Hook & Loop Attachment



Single Pistol Mag Pouch **NEW!**

- Hook & loop attachment
- Constructed of 500 denier nylon
- Holds single pistol magazine
- Adjustable lid accommodates various length magazines
- Dimensions: 5.5"L x 2"W x 1.25"D
- Weight: 0.10 lbs.

52HB01 | BK, CT | \$9.99



M16 Mag Pouch **NEW!**

- Hook & loop attachment
- Constructed of 500 denier nylon
- Holds two 20- or 30-round magazines
- Reinforced bottom with metal grommets for drainage
- Adjustable lid accommodates various length magazines
- Dimensions: 6.75"L x 7.25"W x 1.25"D
- Weight: 0.30 lbs.

52HB00 | BK, CT | \$20.99



DVD Pouch

WHILE SUPPLIES LAST

- Hook & loop attachment
- Constructed of 500 denier ripstop (solid colors) or CORDURA® nylon (MultiCam®)

61ACCD | BK | \$16.99



Triple M16 Mag Pouch

- Hook & loop attachment
- Holds three M16 magazines
- Constructed of 500 denier ripstop (solid colors) or CORDURA® nylon (MultiCam®)

65MV01 | BK, CT | \$36.99



Double Pistol Mag Pouch

WHILE SUPPLIES LAST

- Hook & loop attachment
- Constructed of 500 denier ripstop (solid colors) or CORDURA® nylon (MultiCam®)

61ACDM | BK | \$14.99

Belt Attachment



Belt Mounted Radio Pouch **NEW COLOR!**

- BTS™ belt loop attachment system
- Constructed of 500 denier ripstop (solid colors) or 1000 denier CORDURA® nylon (MultiCam®)
- Fits belts up to 2" wide
- Fits radios up to 8"L x 2.75"W x 1.5"D
- Hook & loop parachute-cord fastening system
- Weight: 0.15 lbs.

52DRP1 | BK, CT, OD, MC | \$18.99 (MC = \$21.99)



Belt Mounted 2-oz. Mace Pouch **NEW COLOR!**

- BTS™ belt loop attachment system
- Constructed of 500 denier ripstop (solid colors) or 1000 denier CORDURA® nylon (MultiCam®)
- Fits belts up to 2" wide
- Hook & loop flap to help prevent accidental discharge
- Dimensions: 4"L x 2"W x 1.5"D
- Weight: 0.09 lbs.

52DMP2 | BK, CT, OD, MC | \$12.99 (MC = \$14.99)



Belt Mounted 4-oz. Mace Pouch **NEW COLOR!**

- BTS™ belt loop attachment system
- Constructed of 500 denier ripstop (solid colors) or 1000 denier CORDURA® nylon (MultiCam®)
- Fits belts up to 2" wide
- Hook & loop flap to help prevent accidental discharge
- Dimensions: 6.5"L x 1.5"W x 1.75"D
- Weight: 0.08 lbs.

52DMP4 | BK, CT, OD, MC | \$13.99 (MC = \$15.99)



Belt Mounted 12 Round Shotgun Pouch **NEW COLOR!**

- BTS™ belt loop attachment system
- Constructed of 500 denier ripstop (solid colors) or 1000 denier CORDURA® nylon (MultiCam®)
- Holds 12 rounds of 12-gauge ammunition
- Elastic loops inside with hook & loop lid closure for retention
- Fits belts up to 2" wide
- Dimensions: 3.25"L x 7.75"W x 1"D
- Weight: 0.19 lbs.

52DS12 | BK, CT, OD, MC | \$25.99 (MC = \$27.99)



Belt Mounted Single Handcuff Pouch **NEW COLOR!**

- BTS™ belt loop attachment system
- Constructed of 500 denier ripstop (solid colors) or 1000 denier CORDURA® nylon (MultiCam®)
- Fits belts up to 2" wide
- Lid with hook & loop closure
- Dimensions: 4.5"L x 4"W (bottom) x 5"W (top)
- Weight: 0.09 lbs.

50HC00 | BK, CT, OD, MC | \$14.99 (MC = \$16.99)



Belt Mounted Double Handcuff Pouch **NEW COLOR!**

- BTS™ belt loop attachment system
- Constructed of 500 denier ripstop (solid colors) or 1000 denier CORDURA® nylon (MultiCam®)
- Fits belts up to 2.5" wide
- Lid with hook & Loop closure
- Dimensions: 5"L x 4.5"W (bottom) x 5"W (top)

50HC01 | BK, CT, OD, MC | \$18.99



Belt Mounted Single M16 Mag Pouch **NEW COLOR!**

- BTS™ belt loop attachment system
- Constructed of 500 denier ripstop (solid colors) or 1000 denier CORDURA® nylon (MultiCam®)
- Fits belts up to 2" wide
- Holds one 30-round M16 magazine
- Lid with hook & loop closure
- Grommets for drainage
- Dimensions: 7"L x 2.75"W x 1"D
- Weight: 0.15 lbs.

52DM17 | BK, CT, OD, MC | \$19.99 (MC = \$21.99)



Belt Mounted Single Pistol Mag Pouch **NEW COLOR!**

- BTS™ belt loop attachment system
- Constructed of 500 denier ripstop (solid colors) or 1000 denier CORDURA® nylon (MultiCam®)
- Horizontal and vertical 2" belt mount
- Compatible with both single- and double-stacked magazines
- Lid with hook & loop closure
- Dimensions: 5"L x 2"W x 1"D
- Weight: 0.12 lbs.

51PM02 | BK, CT, OD, MC | \$14.99 (MC = \$17.99)



Belt Mounted Double Pistol Mag Pouch **NEW COLOR!**

- BTS™ belt loop attachment system
- Constructed of 500 denier ripstop (solid colors) or 1000 denier CORDURA® nylon (MultiCam®)
- Horizontal and vertical 2" belt mount
- Compatible with both single- and double-stacked magazines
- Lid with hook & loop closure
- Dimensions: 5.75"L x 4"W x 1"D
- Weight: 0.02 lbs.

51PM01 | BK, CT, OD, MC | \$22.99 (MC = \$24.99)



Belt Mounted Cross Draw Baton Pouch **NEW COLOR!**

- BTS™ belt loop attachment system
- Constructed of 500 denier ripstop (solid colors) or CORDURA® nylon (MultiCam®)
- Designed to be worn in a cross-draw fashion
- Fits 16" – 21" ASP and similar sized batons
- Open-top design for quick baton deployment
- Internal TalonFlex™ ribs for support
- Custom retention strap
- Weight: 3.2 oz.

52CDB1 | BK, CT, OD, MC | \$18.99 (MC = \$20.99)



Belt Mounted Double Pistol Mag Pouch

- BTS™ belt loop attachment system
- Constructed of ballistic NyTaneon
- TalonFlex™ inserts hold magazine tightly but allow for instant reloads and silent carry
- Holds two pistol magazines
- Flaps can be secured open or closed

52PMK2 | BK, DE | \$20.99



Belt Mounted Triple Pistol Mag Pouch

- BTS™ belt loop attachment system
- TalonFlex™ inserts hold magazine tightly but allow for instant reloads and silent carry
- Holds three pistol magazines
- Flaps can be secured open or closed

52PMK3 | BK, DE | \$33.99



Belt Mounted Utility Pouch

- BTS™ belt loop attachment system
- Single compartment
- Fits belts up to 2.25" wide
- Dimensions: 4.75"L x 7"W x 1.5"D

74UP00 | BK | \$20.99



Belt Mounted Folding Handgun Cartridge Carrier

- BTS™ belt loop attachment system
- Fits 2.25" wide holster belt or trouser belt
- Holds 12 cartridges

74CC00 | BK | \$21.99



Belt Mounted Folding Rifle Cartridge Carrier

- BTS™ belt loop attachment system
- Fits belts up to 2.25" wide
- Holds 10 extra cartridges

74CC01 | BK | \$21.99



Belt Mounted Folding Mag Rifle Cartridge Carrier

- BTS™ belt loop attachment system
- Fits 2.25" wide holster belt or trouser belt

74CC02 | BK | \$22.99



Belt Mounted Handgun Cartridge Slide

- BTS™ belt loop attachment system
- Fits belts up to 2.25" wide
- Holds six extra cartridges

74CS00 | BK | \$13.99



Belt Mounted Rifle Cartridge Slide

- BTS™ belt loop attachment system
- Constructed of tough nylon webbing
- Fits belts up to 2.25" wide
- Holds 10 extra cartridges

74CS01 | BK | \$16.99



Belt Mounted Shotgun Cartridge Slide

- BTS™ belt loop attachment system
- Constructed of tough nylon webbing
- Fits belts up to 2.25" wide
- Holds six extra cartridges

74CS02 | BK | \$16.99

Hybrid Design



Sting Ball Pouch

- Hybrid design is compatible with Speed Clips™, ALICE Clips or BTS™ belt loop attachment system

38CL101 | BK | \$23.99



Camera Pouch

- Hybrid design is compatible with Speed Clips™, ALICE Clips or BTS™ belt loop attachment system
- Holds digital camera, cell phone or PDA
- Rounded flap with hook & loop closure for security
- Padded throughout
- Includes one Speed Clip™ (see page 214)
- Dimensions: 3"W x 4"H x 1.5"D

38CL98 | BK, CT, AU | \$18.99 **WHILE SUPPLIES LAST (AU)**



Double Handcuff Pouch

- Hybrid design is compatible with Speed Clips™, ALICE Clips or BTS™ belt loop attachment system

38CL56 | BK | \$20.99



Multipurpose



Sentinel™

Tactical Flashlight Pouch

- Hybrid design is compatible with Speed Clips™, ALICE Clips or BTS™ belt loop attachment system
- Funnel shape prevents tail-cap switches from accidental engagement
- Belt loop with internal hook & loop for lateral stability
- Hook & loop closure on flap
- Fits belts up to 2.5" wide
- Multipurpose model (38CL92) accommodates BLACKHAWK!® Night-Ops® Legacy™ X6 (75FL001), Legacy X6-P (75FL004), Legacy L6-P (75FL019), Duo PXL-6 (75FL007), Conquest PL-3 (75FL016, 75FL017) and Falcata6V (75201)
- Sentinel™ model (38CL97) accommodates BLACKHAWK!® Night-Ops® Sentinel PL1 (75FL012) and Sentinel PL3-XTR (75FL020)
- Includes one Speed Clip™ (see page 214)
- Does not include flashlights (see page 111 – 114)

Multipurpose | 38CL92 | CT | \$16.99

Sentinel™ | 38CL97 | BK | \$15.99

Look for our Gladius® Light Pouches in the Duty Gear section (see page 89 – 93)!

Fire/EMS Large Utility Pouch with Zipper

- Hybrid design is compatible with Speed Clips™, ALICE Clips or BTS™ belt loop attachment system
- Constructed of durable 1000 denier nylon
- Mesh bottom with drain hole
- Large yellow pull tabs with reflective cording
- Reflective gray piping
- Dimensions: 8"L x 7"W x 3"D = 168 cu. in.



37EL60 | BK, RD | \$39.99



Fire/EMS Mini Medical Pouch

- Hybrid design is compatible with Speed Clips™, ALICE Clips or BTS™ belt loop attachment system
- Constructed of durable 1000 denier nylon
- 2.5" x 2.5" loop panel for attaching Red Cross Medic ID Patch (sold separately, see page 195)
- Large yellow pull tabs with reflective cording
- Reflective gray piping
- Dimensions: 7.25"L x 5"W x 3"D



37EL18 | BK, RD | \$36.99



Fire/EMS Medical Accessory Pouch

- Hybrid design is compatible with Speed Clips™, ALICE Clips or BTS™ belt loop attachment system
- Constructed of durable 1000 denier nylon
- Large yellow pull tabs with reflective cording
- Reflective gray piping
- Dimensions: 7.5"L x 6"W x 2.75"D = 123.75 cu. in.



20EM00 | BK, RD | \$64.99



Securely mounts to S.T.R.I.K.E.® platform or belt



Fire/EMS Utility Pouch for Nalgene® Bottle

- Hybrid design is compatible with Speed Clips™, ALICE Clips or BTS™ belt loop attachment system
- Constructed of durable 1000 denier nylon
- Side-release buckle and hook & loop lid closure
- Reflective gray piping
- Accommodates BLACKHAWK!® Nalgene® Bottle (sold separately, see page 2) or other 32-oz. bottle
- Dimensions: 8.25"L x 4.5"W x 2.5"D = 92 cu. in. (total)

37EL70 | BK, RD | \$39.99



Accessories

Speed Clips™

Our R&D team designed these clips to quickly and efficiently mount and disconnect pouches and other modular gear to any S.T.R.I.K.E.® or PALS/MOLLE platform. They eliminate tedious weaving of bulky straps and allow you to rearrange your kit without hesitation. Tested in combat, they've proven to be both reliable and secure.

- Constructed of durable yet flexible carbon-fiber polymer
- Designed to mount Speed Clip™ 3800 Series pouches (sold separately) to any S.T.R.I.K.E.® or PALS/MOLLE platform
- Can be used with MOLLE 3700 Series or USA MOLLE 3900 Series pouches (sold separately) by tucking strap behind clip, cutting snap off or removing strap entirely
- Multiple lengths span various widths of webbing to accommodate any size pouch: #3 models span three widths, #5 models span five widths, #7 models span seven widths, #9 models span nine widths
- Patent pending

#3 Pack of Two | 38C302 | BK | \$3.99 **WHILE SUPPLIES LAST**

#3 Pack of Six | 38C306 | BK, CT, OD, FG | \$6.99

#5 Pack of Six | 38C506 | BK, CT, OD, FG | \$12.99

#7 Pack of Six | 38C706 | BK, CT, OD, FG | \$12.99

#9 Pack of Six | 38C906 | BK, CT, OD, FG | \$23.99

#9 Pack of Twelve | 38C912 | CT, FG | \$27.99 **WHILE SUPPLIES LAST**



ALICE Clips (4 Pack)

- Authentic military ALICE Clips
- Allows you to attach most BLACKHAWK!® pouches to belt or vest
- Corrosion-resistant for long-lasting performance

HMAC04 | Black | \$6.99



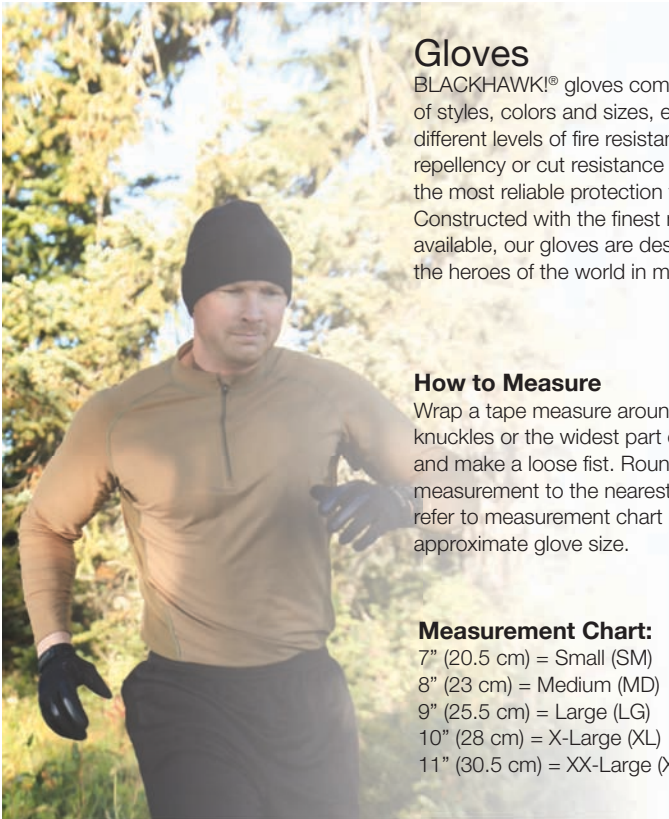

Gloves

BLACKHAWK!® gloves come in a variety of styles, colors and sizes, each with different levels of fire resistance, water repellency or cut resistance to give you the most reliable protection for any job. Constructed with the finest materials available, our gloves are designed with the heroes of the world in mind.

How to Measure

Wrap a tape measure around your knuckles or the widest part of your hand and make a loose fist. Round that measurement to the nearest inch and refer to measurement chart below for approximate glove size.

Measurement Chart:

- 7" (20.5 cm) = Small (SM)
- 8" (23 cm) = Medium (MD)
- 9" (25.5 cm) = Large (LG)
- 10" (28 cm) = X-Large (XL)
- 11" (30.5 cm) = XX-Large (XX)

Look for these icons throughout the Gloves section:



Flash and Flame Protection



Waterborne Ops



Fast-Rope Design



Plush Fleece Comfort



Cut-Resistant Protection



Neoprene Dexterity



Ventilated for Cooling



Insulated Waterproof



Tactical Gloves



S.O.L.A.G.™ Gloves

The ergonomically designed S.O.L.A.G. Gloves feature outstanding flash/flame protection, leather-reinforced fingertips for durability and dual-layer goatskin leather for water repellency and abrasion resistance.

- Dual-layer premium goatskin leather palm and fingertip reinforcements
- Constructed with KEVLAR® (BK, OD) or NOMEX® (CT) for flash/flame protection (CE 420 EN407 X1XXX)
- Padded protection on back of hand and fingers
- Back-of-hand and wrist adjustments for secure fit
- Nylon loop on wrist for easy donning and attachment to carabiners
- Patent #D577,177

With KEVLAR® | 8114 | BK, OD | SM – XX | NSN# 8415-01-507-0699 (MD), NSN# 8415-01-507-0698 (LG), NSN# 8415-01-507-0700 (XL), NSN# 8415-01-507-0701 (XX) | \$79.99
 With NOMEX® | 8114 | CT | SM – XX | NSN# 8415-01-529-8859 (MD), NSN# 8415-01-529-8861 (LG), NSN# 8415-01-529-8864 (XL), NSN# 8415-01-534-7285 (XX) | \$79.99

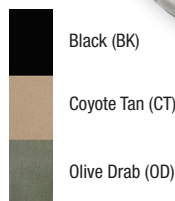

S.O.L.A.G.™ H.D. Gloves



The S.O.L.A.G. H.D. (Heavy Duty) Gloves are enhanced for tactical operations, featuring dual-layer cowhide leather palm and fingertips with leather-covered, molded hard-shell knuckles and fingers.

- Dual-layer cowhide leather palm and fingertip reinforcements
- Constructed with KEVLAR® (BK, OD) or NOMEX® (CT) for flash/flame protection (CE 420 EN407 X1XXX)
- Leather-covered, molded hard-shell knuckles and finger protection
- Back-of-hand and wrist adjustments for secure fit
- Nylon loop on wrist for easy donning and attachment to carabiners
- Patent #D629,996

With KEVLAR® | 8151 | BK, OD | SM – XX | NSN# 8415-99-213-6274 (SM), NSN# 8415-99-213-6275 (MD), NSN# 8415-99-213-6276 (LG), NSN# 8415-99-213-6277 (XL), NSN# 8415-99-213-6278 (XX) | \$99.99
 With NOMEX® | 8151 | CT | SM – XX | \$99.99

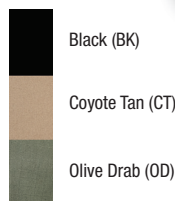

NOMEX® and KEVLAR®—both registered trademarks of DuPont®—are composed of durable, synthetic aramid fibers that deliver outstanding thermal, chemical, tear and abrasion resistance as well as flash/flame protection to keep your hands protected.



Fury™ Gloves

Featuring outstanding flash/flame protection, the Fury Gloves are equipped with leather-reinforced fingertips for maximum durability and dual-layer goatskin leather palms for water repellency and superior abrasion resistance.

- Dual-layer premium goatskin leather palm and fingertip reinforcements
- Constructed with KEVLAR® (BK, OD) or NOMEX® (CT) for flash/flame protection (CE 420 EN407 X1XXX)
- Padded protection on back of hand and fingers
- Nylon loop on wrist for easy donning and attachment to carabiners
- Elastic wrist for secure fit
- Commando™ models feature a shorter gauntlet
- Patent #D577,177

With KEVLAR® | 8093 | BK, OD | SM – XX | \$79.99

With NOMEX® | 8093 | CT | SM – XX | NSN# 8415-01-529-7499 (MD), NSN# 8415-01-529-7498 (LG), NSN# 8415-01-529-7500 (XL) | \$79.99

Commando™ with KEVLAR® | 8141 | BK, OD | SM – XX | \$69.99

Commando™ with NOMEX® | 8141 | CT | SM – XX | SM – XX | NSN# 8415-01-529-7501 (MD), NSN# 8415-01-529-7502 (LG), NSN# 8415-01-529-7503 (XL) | \$69.99

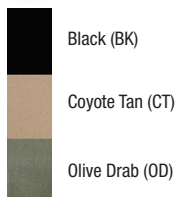

Fury™ H.D. Gloves

Designed for tactical operations, these heavy-duty gloves feature a rugged design with leather-covered, molded hard-shell knuckles and finger protection.

- Dual-layer cowhide leather palm and fingertip reinforcements
- Constructed with KEVLAR® (BK, OD) or NOMEX® (CT) for flash/flame protection (CE 420 EN407 X1XXX)
- Leather-covered, molded hard-shell knuckles and finger protection
- Back-of-hand and wrist adjustments for secure fit
- Nylon loop on wrist for easy donning and attachment to carabiners
- Elastic wrist for secure fit
- Commando™ models feature a shorter gauntlet
- Patent #D629,996

Commando™ with KEVLAR® | 8157 | BK, OD | SM – XX | \$89.99

Commando™ with NOMEX® | 8157 | CT | SM – XX | NSN# 8415-99-213-6279 (SM), NSN# 8415-99-213-6280 (MD), NSN# 8415-99-213-6281 (LG), NSN# 8415-99-213-6282 (XL), NSN# 8415-99-213-6283 (XX) | \$89.99

With KEVLAR® | 8156 | BK, OD | SM – XX | \$99.99

With NOMEX® | 8156 | CT | SM – XX | \$99.99

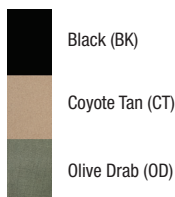



Aviator® Flight Ops Gloves with NOMEX®

Based on a classic flight-glove design, the Aviator Flight Ops Gloves are constructed of soft cowhide leather and provide NOMEX flash/flare protection up to 800 F (427 C).

- Soft, durable cowhide leather palm
- Extra elastic on back of wrist for secure fit

8001 | BK | SM – XX | NSN# 8415-01-504-5173 (MD),
 NSN# 8415-01-504-5562 (LG), NSN# 8415-01-504-3063 (XL) | \$49.99
 8001 | CT | SM – XX | NSN# 8415-01-519-8857 (MD), NSN# 8415-01-
 521-9369 (LG), NSN# 8415-01-521-9350 (XL) | \$49.99
 8001 | OD | SM – XX | NSN# 8415-01-521-9363 (LG),
 NSN# 8415-01-521-9344 (XL) | \$49.99

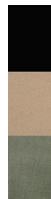

Black (BK)

Coyote Tan (CT)

Olive Drab (OD)



Tactical Aviator® Flight Ops Gloves with KEVLAR®

Combining a classic flight glove design with KEVLAR flash/flare protection up to 800 F (427 C), these gloves are built to survive harsh tactical climates.

- 4" shorter cuff than Aviator® Flight Ops Gloves with NOMEX® (see above)
- Soft, durable cowhide covers entire palm for full-coverage protection
- Extra elastic on back of wrist for secure fit

8011 | BK | SM – XX | NSN# 8415-01-529-8865 (MD), NSN# 8415-01-
 521-9345 (LG), NSN# 8415-01-521-0936 (XL) | \$44.99



S.O.L.A.G.™ Full-Finger and Half-Finger Gloves

These all-purpose tactical gloves provide a secure grip on wet surfaces and are made using quick-drying synthetic materials—perfect for waterborne ops. Choose between full-finger or half-finger designs.

- Does not include flash/flare protection
- Dual back-of-hand and wrist adjustments for secure fit
- Nylon loop on wrist for easy donning and attachment to carabiners
- Patents pending

Full-Finger | 8063 | BK | SM – XX | NSN# 8415-01-505-9783 (MD),
 NSN# 8415-01-561-4295 (LG), NSN# 8415-01-561-4781 (XL), NSN#
 8415-01-560-5682 (XX) | \$44.99
 Half-Finger | 8068 | BK | SM – XX | NSN# 8415-01-521-9355 (LG),
 NSN# 8415-01-521-9366 (XL) | \$39.99



Strike Force™ Heavy-Duty Fast-Rope Gloves



Designed for repeat fast-rope training and operations, these heavy-duty gloves are constructed of reinforced top-grain leather for dependable service.

- Heat barrier palm pad
- Quick-release wrist cinch strap and pull-on loop
- Use as over-glove with any BLACKHAWK® tactical gloves

8053 | BK | SM – XX | NSN# 8415-01-522-0430 (LG),
NSN# 8415-01-522-0426 (XL) | \$79.99



Python™ Advanced Light Rappel Gloves



Get reliable, hardwearing performance with the Python Advanced Light Rappel Gloves—perfect for SAR rappelling or as a fast-rope over-glove.

- Thick, durable suede leather shell and reinforced palm shield
- Heavy-duty, quick-release wrist cinch strap

8021 | BK | SM – XX | \$40.99



Fleece Tac Gloves



With a textured palm and fingertip reinforcements, the Fleece Tac Gloves provide a secure wet-weather grip while still giving you plenty of dexterity for tactical ops.

- Plush fleece for warm comfort
- Textured palm and fingertip reinforcements
- Shirred elastic wrist keeps cold out
- Pull-on loop for easy donning or attachment to carabiners

8077 | BK | SM – XX | \$29.99



Patrol Gloves

CRG1 and CRG2 Cut-Resistant Patrol Gloves



The ergonomically designed CRG1 and CRG2 gloves feature a durable synthetic leather palm and flexible neoprene/spandex shell to deliver form-fitting comfort. The CRG1 model uses KEVLAR® on the palm while the CRG2 model uses Spectra Guard™ lining for full-hand protection.

- Reinforced thumb cradle
- Pull-on loop for easy donning or attachment to carabiners
- Adjustable hook & loop closure for secure fit
- KEVLAR® palm provides moderate* cut resistance to inside palm of hand (CRG1)
- Spectra Guard™ lining provides high* cut resistance to protect entire hand (CRG2)

CRG1 | 8152 | BK | SM - XX | \$44.99

CRG2 | 8153 | BK | SM - XX | \$79.99

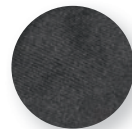

Spectra Guard™
Cut-Resistant
Glove Lining

High*
Cut Resistance



DuPont™ KEVLAR®
Cut-Resistant
Glove Lining

Moderate*
Cut Resistance

Neoprene Patrol Gloves



If you need working protection, moderate warmth and maximum dexterity in wet or dry conditions, then you can't go wrong with the ergonomic, flexible Neoprene Patrol Gloves.

- 1.5 mm neoprene back for moderate warmth
- Polyurethane palm with ergonomically positioned gel contact points provide durability and control even in wet conditions
- Narrowed box-tip fingers for precise feel
- Adjustable hook & loop closure for comfortable, secure fit

8150 | BK | SM - XX | \$29.99



Shooting Gloves



Hot Ops™ Ventilated Hot Weather Gloves

Designed for warm-weather use, these shooting gloves feature a durable, synthetic leather palm and offer substantial protection and ventilation.

- Ergonomic cut and flexible shell for maximum dexterity
- Perforated neoprene and breathable 3-D mesh back
- Reinforced thumb cradle and finger fourchettes
- Pull-on loop for easy donning or attachment to carabiners
- Adjustable hook & loop closure for secure fit

8155 | BK | SM – XX | \$34.99



Cool Weather Shooting Gloves

Ideal for outdoor activities in cool to cold weather, these shooting gloves incorporate a stretch shell that follows the contours of your hand for complete dexterity while a snug extended cuff keeps the chill out.

- Plush fleece interior for warm comfort
- Ergonomically positioned gel contact points for durability and control

8154 | BK | SM – XX | \$24.99





ECW2 Winter Operations Gloves



The ECW2 Winter Operations Gloves offer a plush fleece, brushed tricot lining with 200-gram Silk Lite insulation and breathable, waterproof Hipora® Beta liners.

- Rugged, water-resistant Taslan nylon shell
- Textured palm reinforcement for secure grip and durability
- Lean trigger-ready index finger
- Easy-off pull tab on middle finger
- Snug elastic cuff and gauntlet

8086 | BK | SM – XX | \$49.99



Tricot is a smooth, close-knit fabric with outstanding stretch characteristics.



ECW Pro Winter Operations Gloves



Specifically designed for cold-weather operations, these winter gloves give you all the benefits of a plush fleece, brushed tricot lining with additional 200-gram insulation.

- Breathable, waterproof Hipora® Beta liner
- Water-resistant, breathable Eclipse™ EP nylon shell
- Shirred wrist with quick-release cinch strap
- Drawstring-adjustable gauntlet with internal snow cuff
- Textured palm and finger reinforcement for secure grip and durability
- Lean trigger-ready index finger
- Easy-off pull tab on middle finger
- Goggle squeegee on left thumb

8087 | BK | SM – XX | \$69.99

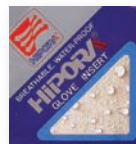

Head/Eye Wear



Heavyweight Bibbed Balaclava



Heavyweight Balaclava



Lightweight Balaclava

Flash/Flame-Resistant Balaclavas with NOMEX®

Get flash/flame protection for your head and neck with all three of our Flash/Flame-Resistant Balaclavas with NOMEX. Choose from Heavyweight, Heavyweight Bibbed or Lightweight models.

- Constructed of 7.4-oz. NOMEX® (Heavyweight and Heavyweight Bibbed) or 6-oz. NOMEX (Lightweight)
- Internal flat-seam stitching prevents irritation when wearing a helmet
- Extended bib protection (Heavyweight Bibbed only)
- Length: 15" (Heavyweight), 18.25" (Heavyweight Bibbed), 18" (Lightweight)

Heavyweight | 333002 | BK, CT, OD, FG | NSN# 8415-01-522-2961 (BK) | \$27.99

Heavyweight Bibbed | 333004 | BK, CT, OD, FG | NSN# 8415-01-517-6323 (BK), NSN# 8415-01-529-7476 (CT), NSN# 8415-01-529-7477 (OD) | \$39.99

Lightweight | 333005 | BK, CT, OD, FG | NSN# 8415-01-591-9066 (BK) | \$17.99

Looking for a balaclava to wear in warm or hot weather? Choose our Lightweight Balaclava with NOMEX®. It'll give you plenty of protection without heating you up.

Polypropylene Balaclava

Combining moisture-wicking properties with internal flat-seam stitching, this balaclava keeps your head and neck warm while giving you the protection you need.

- Does not provide flash/flame protection
- Internal flat-seam stitching prevents irritation when wearing a helmet

333003 | BK | \$15.99



Tactical Shemagh

The 100% cotton Tactical Shemagh is traditional desert headwear designed to protect the head and neck from sun, sand or other harsh desert elements.

- Currently in use with U.S. and coalition forces in Iraq and Afghanistan
- Dimensions: 44" x 44" (112 cm x 112 cm)

330005 | CT, OD | NSN# 8440-01-529-6427 (CT), NSN# 8440-01-529-6429 (OD) | \$19.99



A.C.E. Tactical Goggles

Using the highest quality anti-scratch and anti-fog treatments available, these tactical goggles deliver 180-degree peripheral vision, unrivaled impact resistance and exceptional optical clarity.

Frame:

- Includes cloth carrying case and soft case/cleaning bag (open on both ends and can be positioned over goggles for protection when worn up on helmet)
- Flexible Santoprene™ frame
- Low-profile, close-fitting frame fits comfortably under helmet (ACH, MCH, PASGT)
- Removable nose guard constructed of durable nylon
- 35 mm non-slip, silicone-backed elastic head strap angled upwards for even pull against face
- Excellent wind and dust protection via foam dust filters over ventilation areas

Lens:

- Exceeds ANSI Z87.1 & MCEPS standards for impact resistance
- Meets or exceeds all ANSI & EN optical clarity standards
- 3.15 mm in center and 3.0 mm thick to side for perfect optics throughout entire curvature of lens
- Lens exterior has highest quality proprietary anti-scratch treatment
- Lens interior has highest quality anti-fog treatment
- Includes clear lens
- Also available in Gray/Smoke lens (sold separately, see right)

85AC00 | BK, CT, FG | \$99.99



Foliage Green

Coyote Tan

A.C.E. Replacement Lens

- Available in Clear (CL) or Gray/Smoke (GY)

85RL00 | CL, GY | \$24.99



Special Operations Tactical Goggles

These robust goggles are designed for extreme comfort thanks to micro-cellular face foam, upper and lower ventilation slots and a lean, ergonomic design that won't interfere with helmets or other headgear.

- Constructed of extremely durable, flexible, soft urethane
- Meets worldwide safety standards for optical purity (ANSI Z80.3, AS1067 and EN1836)
- Dual-pane lens and anti-fog-impregnated acetate inner lens for maximum anti-fog protection
- Shatterproof polycarbonate outer lens
- 99.9% UVA, UVB, and infrared protection
- Includes clear lens (included)
- Available in Yellow or Orange lens (sold separately, see below)

8118 | Black | \$69.99



Spec Ops Replacement Lens WHILE SuPPLIES LAST

- 8119 | Clear | \$22.99
- 8120 | Yellow | \$22.99
- 8121 | Orange | \$22.99



Knee/Elbow Pads

Neoprene Elbow Pads

Keep noise levels down and comfort levels up with the Neoprene Elbow Pads. Featuring layered construction and closed-cell foam padding, these pads provide excellent shock resistance and little or no moisture retention.

- Textured outer contact patch for durability and secure grip
- Contoured inner section cradles elbow and prevents slippage and lateral movement
- Easy slip-on design

809200 | BK | \$14.99



Neoprene Knee Pads

Combining closed-cell foam padding with layered construction, the Neoprene Knee Pads are designed to keep you comfortable while effectively reducing noise.

- Closed-cell foam padding provides excellent shock resistance and little or no moisture retention
- Textured outer contact patch for durability and secure grip
- Internal grip patch and contoured ledge prevent pad slippage
- Dual-secure hook & loop straps keep pad in place

809100 | BK, CT, OD | \$33.99



Advanced Tactical Elbow Pads V.2

The Advanced Tactical Elbow Pads V.2 deliver substantial protection and flexibility in a lightweight yet rugged package. Closed-cell foam padding provides excellent shock resistance and little or no moisture retention.

- 600 denier nylon shell
- Non-slip, flexible, molded polyurethane cap
- Contoured interior ledge prevent pad slippage
- Hook & loop elastic straps keep pad in place

802600 | BK, CT, OD, FG | NSN# 8315-01-517-7046 (BK), NSN# 4240-01-527-4736 (OD) | \$17.99



Advanced Tactical Knee Pads V.2

These lightweight, hardwearing knee pads incorporate closed-cell foam padding for shock resistance and little or no moisture retention while contoured interior ledges prevent pads from slipping downward.

- 600 denier nylon shell
- Injection-molded flex cap design
- Minimizes gap between bottom of cap and nylon carrier when flexed
- Padded side extensions for additional comfort and improved strap positioning
- Hook & loop elastic straps keep pad in place

808300 | BK, CT, OD, FG | NSN# 4240-01-517-8650 (BK), NSN# 4240-01-527-4431 (OD) | \$24.99



Tactical Knee Pads (Pair)

- Patented

87KP00 | CT | \$19.99



Tactical Elbow Pads (Pair)

- Patented

87EP00 | CT | \$15.99



Slip-in Neoprene Knee Pads (Pair)

- Constructed of 5 mm neoprene
- Smooth nylon backing for comfort and easy insertion
- Contoured ergonomic cut for full range of motion

86KP00 | BK | \$9.99



Sportster™

When we created our Sportster product line, our goal was to outfit novice and casual shooters with quality gear at a price that fits any budget. From weapon cases and bags to pouches and pistol rugs, Sportster delivers affordability without sacrificing the quality you expect from BLACKHAWK!. So whether you make frequent trips to the range or are new to the world of sport shooting, our Sportster gear is definitely within range.

Sportster™ Titan™ FXS – Rifle Rest **NEW!**

Featuring a strong industrial design, the Sportster Titan FXS gives shooters a solid shooting platform, holding the gun firmly on target. It allows for quick elevation and windage adjustment to accommodate a variety of rifle configurations.

- Premium-grade rest for long-range accuracy
- Durable cast aluminum and steel tube construction
- Compatible with magazine-fed rifles
- Ambidextrous design
- Three inches of adjustable length for custom fit
- Rapid elevation (2.25 inches) and windage (1.375 inches) adjustment
- Removable steel weight tray
- Ergonomic, rapid-adjust elevation wheel
- Adjustable steel feet with removable polymer covers
- Padded rear rest cover
- Quality pre-filled front shooting bag

71RR00 | BK | \$179.99



Sportster™ Titan™ FX – Rifle Rest **NEW!**

This high-grade rifle rest is designed to perform time after time, shot after shot. Featuring durable cast aluminum and steel tube construction, the Sportster Titan FX offers precise elevation adjustment and gives shooters a stable, level platform.

- High-grade rest for steady, repeatable performance
- Durable cast aluminum and steel tube construction
- Compatible with most magazine-fed rifles
- Ambidextrous design
- Rapid elevation adjustment (2.25 inches)
- Ergonomic, rapid-adjust elevation wheel
- Adjustable steel feet with removable polymer covers
- Quality pre-filled front shooting bag

71RR01 | BK | \$149.99





Sportster™ Titan™ III – Rifle Rest **NEW!**

Shoot true and get maximum stability with the Sportster Titan III. Featuring durable cast aluminum and steel construction, this quality three-legged rifle rest gives shooters 2.25 inches of rapid elevation adjustment in a solid, ergonomic configuration.

- Unique industrial design and appearance
- Durable cast aluminum and steel construction
- Integrated stock stop
- Rapid elevation adjustment (2.25 inches)
- Ergonomic, rapid-adjust elevation wheel
- Adjustable steel feet with removable polymer covers
- Quality pre-filled front shooting bag
- Includes polymer-filled rear shooting bag

71RR02 | BK | \$99.99



Sportster™ Titan™ R2 – Rifle Rest **NEW!**

Featuring durable molded polymer and steel tube construction, the Sportster Titan R2 holds a rifle securely, delivering long-range accuracy while in the field or on the hunt. This rugged rest allows shooters to quickly modify the elevation with 2.25 inches of adjustment.

- Unique industrial design and appearance
- Durable molded polymer and steel tube construction
- Compatible with magazine-fed rifles
- Removable steel weight tray
- Ambidextrous design
- Rapid elevation adjustment (2.25 inches)
- Ergonomic, rapid-adjust elevation wheel
- Adjustable steel feet with removable polymer covers
- Quality pre-filled front shooting bag

71RR03 | BK | \$119.99



Sportster™ Titan™ VR – Rifle Rest **NEW!**

With 7.5 inches of height adjustment and 360-degree rotation, the Sportster Titan VR is versatility and convenience at its finest. Its solid steel tube construction and adjustable design make it a must-have shooting accessory for a day at the range or in the field.

- Durable steel tube construction
- Rapid elevation adjustment (7.5 inches)
- Fine adjustment twist knob
- Rotational center pivot for 360-degree rotation
- Non-marring vinyl-coated firearm yoke
- Adjustable front and rear yoke
- Rubber feet

71RR04 | BK | \$69.99

Sportster™ Shooting Rest Weight Bags **NEW!**

Secure your favorite shooting rest with the convenient Sportster Shooting Rest Weight Bags. The small version is designed to hold a 25-lb. lead shot bag or 7 lbs. of sand while the large model holds approximately 20 lbs. of desired media.

- Unfilled shooting rest weight bag
- Constructed of durable 600 denier polyester
- Compatible with BLACKHAWK!® Sportster™ and other shooting rest trays
- Convenient carry handles for easy transport
- Heavyweight zipper
- Small model (74SB02) holds 25-lb. lead shot bag or approximately 7 lbs. of sand or other designed media
- Large model (74SB03) holds approximately 20 lbs. of sand or other desired media
- Dimensions: 9.5”L x 6”W x 2.5”H (74SB02), 12.75”L x 8”W x 2.5”H (74SB03)

Small | 74SB02 | BK | \$16.99
 Large | 74SB03 | BK | \$18.99



74SB02BK



74SB03BK

Sportster™ Multi-Level Sandbag

For a steady aim on the go, the new Multi-Level Sandbag is a highly portable, sub-compact shooting rest offering a variety of configurations. Ideal for fence posts, shooting benches or other various setups, this versatile sandbag guarantees a convenient and stable rest for any situation.

- Easily transforms into different configurations
- Pre-filled sandbag
- Dimensions: 6.5”L x 5.5”W x 4.5”H (stacked), 12.5”L x 5.5”W x 2.25”H (flat)
- Weight: 5.76 lbs.

74SB00 | BK | \$26.99



Sportster™ TraverseTrack™ Bipod **NEW SIZE!**

Combining pivot and traverse functions with a time-tested bipod design, the Traverse Pivot Bipod is an industry first. The new horizontal traverse feature allows you to steadily track a moving target or change from target to target without repositioning the firearm. And when you're shooting on an uneven surface, the pivot action lets you swivel the firearm to either side, giving you a level shooting platform.

- Durable all-metal construction with robust tubular legs
- Horizontal traverse for smooth target acquisition and tracking
- Pivot action for level shooting on uneven terrain
- Rapid-adjust lever lock
- Spring-return telescoping legs
- Easily attaches to sling swivel stud

6” – 9” | 71BP09 | BK | \$69.99
 9” – 13” | 71BP10 | BK | \$69.99
 13.5” – 23” | 71BP11 | BK | \$71.99
 14.5” – 29.25” | 71BP16 | BK | \$74.99 **NEW!**





Sportster™ Bipod

- Compact and lightweight design
- No-rust anodized legs with increased spring tension
- Spring-return telescoping legs
- Unshakable prone and bench shooting
- Easily attaches to sling swivel

6" – 9" | 71BP03 | BK | \$45.99
 9" – 13" | 71BP02 | BK | \$48.99
 13.5" – 23" | 71BP01 | BK | \$51.99
 14.5" – 29.25" | 71BP04 | BK | \$54.99



Sportster™ Pivot Bipod

- Compact and lightweight design
- Pivot eliminates rifle canting on uneven terrain
- Rapid-adjust pivot lever
- No-rust anodized legs with increased spring tension
- Spring-return telescoping legs
- Unshakable prone and bench shooting
- Easily attaches to sling swivel

6" – 9" | 71BP05 | BK | \$54.99
 9" – 13" | 71BP06 | BK | \$57.99
 13.5" – 23" | 71BP07 | BK | \$60.99
 14.5" – 29.25" | 71BP08 | BK | \$63.99



Sportster™ Bipod Picatinny Rail Adapter

Mount your favorite bipod to any MIL-STD 1913 Picatinny rail with this easy-to-use adapter. It provides maximum versatility for bipod placement options.

- Attach a bipod to any firearm with a Picatinny rail
- Easy to attach and detach

71RA01 | BK | \$15.99



Weapon Cases and Bags

Store and transport your long guns, pistols and magazines securely in your choice of quality weapon cases, range bags or pistol rugs. Each comes fully equipped with the following standard features:

- Constructed of tight-weave, heavyweight 600 denier polyester with thick PVC laminate for stability
- Dual-density foam with internal open-cell foam for weapon protection and external closed-cell foam for impact protection
- Internal soft fabric protects firearm finish
- Wraparound tactical web handles for superior weight support
- Rugged tactical webbing on shoulder straps and contact points
- Heavy seam binding with two rows of locked stitching for durability
- Self-healing, heavy-duty, oversized coil zippers
- Lockable closure design (weapon cases only)



74SG36BK

Sportster® Tactical Carbine Case **NEW!**

- Includes all standard weapon case and bag features (see top of page)
- Holds carbines up to 36" long
- Four external mag pockets and two large accessory pockets for gear
- Dimensions: 36"L x 11.5"W x 3"D

74SG36 | BK | \$39.99



74SG02BK

Sportster® Tactical Rifle Case

- Includes all standard weapon case and bag features (see top of page)
- Holds rifles up to 42.5" long (74SG02) or 44" long (74SG03)
- Five external mag pockets and two large accessory pockets for gear
- Dimensions: 42.5"L x 11.5"W x 3"D (74SG02), 44"L x 12.5"W x 3"D (74SG03)

Small | 74SG02 | BK | \$40.99
Large | 74SG03 | BK | \$43.99



74SG02BK



74SG03BK



74SG44BK



Sportster® Scoped Rifle Case

- Includes all standard weapon case and bag features (see page 230)
- Holds scoped rifles up to 44" long (74SG44) or 48" long (74SG48)
- Multiple rows of S.T.R.I.K.E.® webbing for attaching pouches or accessories
- Dimensions: 45"L x 10"W x 2"D (74SG44), 51.5"L x 10"W x 2"D (74SG48)

74SG48BK



44" Scoped Rifle Case | 74SG44 | BK | \$26.99
 48" Scoped Rifle Case | 74SG48 | BK | \$27.99

74SG01BK



Sportster® Shotgun Case

- Includes all standard weapon case and bag features (see page 230)
- Holds shotguns up to 52" long
- Multiple rows of S.T.R.I.K.E.® webbing for attaching pouches or accessories
- Dimensions: 53"L x 8"W x 2"D

74SG01 | BK | \$24.99

74SR55BK



Sportster® 55" Heavy Barrel Rifle Case

- Includes all standard weapon case and bag features (see page 230)
- Oversized case for full-size PSRs inside tactical hard case
- Holds scoped rifles up to 55" long
- Dimensions: 55"L x 12.75"W x 1.5"D

74SR55 | BK | \$49.99



Sportster® Modular Weapons Case

- Includes all standard weapon case and bag features (see page 230)
- Modular discreet case with removable, padded divider to separate two firearms or one firearm and full set of pouches
- Internal S.T.R.I.K.E.® webbing for attaching pouches or accessories
- Includes Muzzle Retainer and Weapon Retainer (see page 234)
- Can also accommodate accessories such as the Barrel Bag (Small/Large), Accessory Pouch (Large), Wrench Pouch and Large Optics Pouch (all sold separately, see page 234 – 235)
- Dimensions: 36"L x 13"W x 5"D



74SG04 | BK | \$59.99



Includes Muzzle Retainer and Weapon Retainer. Other pouches not included.

- | | |
|--------------------------------------|---------------------------------|
| 1 Accessory Pouch (Large) – 74AP01BK | 5 Weapon Retainer – 74WR00BK |
| 2 Barrel Bag (Large) – 74BB01BK | 6 Barrel Bag (Small) – 74BB00BK |
| 3 Large Optics Pouch – 74OP01BK | 7 Muzzle Retainer – 74MR00BK |
| 4 Wrench Pouch – 74WP00BK | |



Sportster® Pistol Rug

- Includes all standard weapon case and bag features (see page 230)
- Classic pistol rug design protects firearm and provides easy transport
- Fits most pistols and revolvers
- Dimensions: 12.5"L x 8" W x 1.25"D (74PR01), 15"L x 8" W x 1.25"D (74PR02)

Medium | 74PR01 | BK | \$9.99

Large | 74PR02 | BK | \$10.99



Sportster™ Pistol Range Bag

- Includes all standard weapon case and bag features (see page 230)
- Main internal pocket with dual-slider opening for easy access to contents
- Two external slash pockets hold magazines and other small items
- Includes two flannel-lined rugs to protect handgun inside main compartment
- Multiple rows of S.T.R.I.K.E.® webbing for attaching pouches or accessories
- Dimensions: 16"L x 9"W x 8"D

74RB02 | BK | \$31.99



Sportster™ Deluxe Range Bag

- Includes all standard weapon case and bag features (see page 230)
- Three large dual-zippered compartments and one slash pocket
- Two internal pockets hold two handguns
- Eight internal mag pockets hold magazines securely
- One internal pocket with dual-slider opening for easy access to contents
- Multiple rows of S.T.R.I.K.E.® webbing for attaching pouches or accessories
- Dimensions: 15"L x 11"W x 10"D

74RB01 | BK | \$57.99



Sportster™ Shooter's Bag

- Includes all standard weapon case and bag features (see page 230)
- Two large dual-zippered compartments and one slash pocket
- Two internal pockets hold two handguns
- Eight internal mag pockets hold magazines securely
- Multiple rows of S.T.R.I.K.E.® webbing for attaching pouches or accessories
- Dimensions: 13"L x 9"W x 4.5"D

73SB00 | BK | \$29.99



Sportster™ Accessory Pouch

- Constructed of durable 600 denier polyester
- Perfect for wrenches, cleaning or range supplies, glasses, earplugs, earmuffs, etc.
- Small model (74AP00) includes two #5 Speed Clips™ (see page 214)
- Large model (74AP01) includes two #7 Speed Clips™ (see page 214)
- Dimensions: 7"L x 3.5"W x 2.25"D (74AP00), 9"L x 3.25"W x 2.25"D (74AP01)

Small | 74AP00 | BK | \$12.99

Large | 74AP01 | BK | \$12.99



74AP00BK

74AP01BK

Sportster™ Wrench Pouch

- Constructed of durable 600 denier polyester
- Perfect for cleaning supplies and tools such as torque and allen wrenches (not included)
- Dimensions: 7.5"L x 1.75"W x 1.25"D

74WP00 | BK | \$9.99



Perfect for storing cleaning supplies or tools (not included)



Sportster™ Muzzle Retainer

- Constructed of durable 600 denier polyester
- Holds muzzle securely in place
- Includes two #5 Speed Clips™ (see page 214)
- Dimensions: 5"L x 1.375"W (tapering to .75"W)

74MR00 | BK | \$9.99



Sportster™ Weapon Retainer (Set of 2)

- Constructed of durable 600 denier polyester
- Hook & loop closure
- Holds weapon securely in place
- Dimensions: 12.5"L x 2"W

74WR00 | BK | \$9.99

Sportster™ Utility Pouch

- Constructed of tight-weave, heavyweight 600 denier polyester with thick PVC laminate for stability
- Heavy-duty tactical webbing for superior weight support
- Integral foam design using closed-cell foam for protection
- Rugged tactical webbing on shoulder straps and contact points
- Heavy seam binding with two rows of locked stitching for durability
- Self-healing, heavy-duty, oversized coil zippers
- Dimensions: 7"L x 4.75"W x 1.5"D

74UP01 | BK | \$12.99





Sportster™ Small Optics Pouch

- Constructed of durable 600 denier polyester
- Padded for optics protection
- Perfect for red dots or small binoculars
- Hook & loop closure
- Includes two #5 Speed Clips™ (see page 214)
- Dimensions: 7"L x 3.5" W x 2.75"W

74OP00 | BK | \$14.99



B990232BK



B990230BK

Sportster™ Large Optics Pouch

- Constructed of durable 600 denier polyester
- Padded for optics protection
- Fits most variable power scopes with rings
- Includes three #5 Speed Clips™ (see page 214)
- Dimensions: 14"L x 4.25" W x 3.25"W

74OP01 | BK | \$14.99

Sportster® Universal Mag Case

- Constructed of durable 600 denier polyester
- Holds most pistol magazines and folding knives
- Fits belts up to 2.25" wide
- Hook & loop flaps for easy adjustment

Single Mag Case | B990232 | BK | \$12.99
Double Mag Case | B990230 | BK | \$14.99



Sportster® 20-Round Cartridge Pouches

- Constructed of durable 600 denier polyester
- Large enough for popular .338 Lapua magnum cartridges (74CC04)
- Tough elastic loops hold 20 rounds quietly while protecting contents
- Heavy-duty 2" belt loop webbing
- Large external zippered pocket holds additional items
- Heavy seam binding with two rows of locked stitching for durability
- Includes two Speed Clips™ (see page 214)

Standard (Fits .30-06 and .308) | 74CC03 | BK | \$19.99
Magnum (Fits .338 Lapua and .300 Winchester) | 74CC04 | BK | \$19.99



Sportster™ Barrel Bag **WHILE SUPPLIES LAST**

- Fits accessory barrels up to 22" long
- Padded barrel bag
- Dimensions: 19"L x 1.625" W x 1.75"W (74BB00), 23.25"L x 1.75"W x 1.75"W (74BB01)

Small | 74BB00 | BK | \$14.99
Large | 74BB01 | BK | \$19.99



74BB01BK





Sportster® Standard Holster **NEW FITS!**

The Sportster Standard Holster features a pressure adjustable detent retention system that allows the shooter to customize the amount of retention on the handgun. This system grabs onto the pistol's trigger guard and holds tight for reliable and secure weapon carry.

- Available in Matte Finish only
- Includes belt loop and paddle platform

415600 | BK-R, BK-L | Size 00 | Glock 17/22/31 | \$21.99
 415601 | BK-R, BK-L | Size 01 | Glock 26/27/33 | \$21.99
 415602 | BK-R, BK-L | Size 02 | Glock 19/23/32/36 | \$21.99
 415603 | BK-R | Size 03 | 911 Gov't and Clones without rail | \$21.99
 415604 | BK-R | Size 04 | Beretta 92/96/M9 STD or A1 with rail (not Elite/Brig) | \$21.99
 415605 | BK-R | Size 05 | Sig 228/229 with or without rail | \$21.99
 415606 | BK-R | Size 06 | Sig 220/225/226 with or without rail | \$21.99
 415607 | BK-R | Size 07 | Springfield XD 4" and XDM 3.8" | \$21.99
 415609 | BK-R | Size 09 | H&K USP Compact | \$21.99
 415613 | BK-R | Size 13 | Glock 21, S&W M&P .45 and 9/.40 Pro | \$21.99 **NEW!**
 415625 | BK-R | Size 25 | S&W M&P 9/.40, SD 9/.40 and Sigma | \$21.99 **NEW!**
 415630 | BK-R | Size 30 | Glock 29/30/39 | \$21.99 **NEW!**
 415641 | BK-R | Size 41 | Ruger SR9 | \$21.99 **NEW!**
 415642 | BK-R | Size 42 | Colt 1911 Commander | \$21.99 **NEW!**
 415649 | BK-R | Size 49 | Ruger LC9 | \$21.99 **NEW!**



Sportster® Bandolier Scoped Handgun Holster **NEW!**

The Sportster Bandolier Scoped Handgun Holster is the perfect solution for carrying a scoped handgun into the field—whether you're left-handed or right-handed.

- Designed for handgun hunters or sport shooters
- Constructed of durable 600 denier polyester laminate
- Nylon web sight channel
- Ambidextrous shoulder and belt carry
- Removable flap holds firearm in place
- Fits medium- and large-frame autos and revolvers
- Small model (74BH03) fits barrels up to 6" long
- Medium model (74BH04) fits barrels up to 8.5" long
- Large model (74BH13) fits barrels up to 10.5" long

Small | 74BH03 | BK, R3 | \$29.99 (R3 = \$34.99)
 Medium | 74BH04 | BK, R3 | \$29.99 (R3 = \$34.99)
 Large | 74BH13 | BK, R3 | \$29.99 (R3 = \$34.99)

Sportster® Inside-the-Pocket Holster

- Constructed of suede-like laminate to keep holster in pocket
- Smooth nylon lining for easy draw
- Protects gun from debris and breaks up outline in pocket

B990222 | BK | Size 03 | 2" 5-Shot Revolvers (Ruger, Kel-Tec, Kahr and Taurus .380) | \$10.99
 B990223 | BK | Size 04 | Most Sub-Compact 9/.40 Autos (Glock 26/27, Kahr PM9) | \$10.99



Sportster® Right-Handed Hip Holster

- Constructed of durable 600 denier polyester
- Classic medium high-ride design
- Molded belt loop fits belts up to 2" wide
- Robust retention strap
- Nylon web sight channel

B990216 | BK | Size 02 | 3" – 4" Barrel Medium/Large Double-Action Revolvers (S&W 64/66, Taurus 66/Judge, Ruger GP-100) | \$13.99
 B990217 | BK | Size 03 | 5" – 6.5" Barrel Medium/Large Double-Action Revolvers (S&W 66 with 6" Barrel, Colt Python with 6" Barrel) | \$13.99
 B990218 | BK | Size 04 | 4.5" – 5" Barrel Large Autos, Open End (Beretta 92/96, Colt 1911) | \$13.99
 B990219 | BK | Size 07 | 3.75" – 4.5" Barrel Large Autos, Open End (Glock 17/22, S&W M&P, Ruger SR9) | \$13.99
 B990220 | BK | Size 08 | 3.25" – 3.75" Barrel Medium/Large Autos (Sig 229, Springfield XD, Glock 19/23) | \$13.99
 B990221 | BK | Size 09 | 2" Small Frame 5-Shot Revolvers with Hammer Spur (S&W Model 36/60, Taurus 85, Ruger SP-101) | \$13.99



Sportster® Compact Belt Slide Holster

- Ambidextrous design
- Fits most autos and revolvers
- Reversible thumb break
- Nylon web belt loops on both sides
- Fits belts up to 1.5" wide

B990260 | BK | \$19.99



Sportster® Ambidextrous Holster with Mag Pouch

- Constructed of durable 600 denier polyester
- Wear inside pants or on belt
- Reversible thumb break and dual belt loops for right- or left-handed use
- Removable spring-steel clip secures holster to waistband for inside-the-pants wear
- Includes built-in spare mag pouch (B990262 does not include mag pouch)

B990262 | BK | Size 02 | 4" Barrel Med/Inter Double Action Revolver (S&W 64/66, Taurus 66/Judge, Ruger GP-100) | \$21.99
 B990263 | BK | Size 03 | 4.5" – 5" Barrel Large Auto (Beretta 92/96, Colt 1911) | \$21.99
 B990234 | BK | Size 05 | 3.75" – 4.5" Barrel Large Autos (Glock 17/22, Ruger SR9, Smith M&P) | \$21.99
 B990259 | BK | Size 06 | 3.25" – 3.75" Barrel Medium/Large Autos (Sig 229, Springfield XD, Glock 19/23) | \$21.99



Sportster® 3-Slot Pancake Holster

- Ambidextrous design with reversible/adjustable retention strap and thumb break
- Three-slot design for strong-side, kidney or cross-draw mount options
- Belt slots pull holster body close for better concealment
- Lined with a smooth, snag-resistant material
- Fits belts up to 1.75" wide

B990261 | BK | Size 05 | 3.75" – 4.5" Barrel Large Autos (Glock 17/22, Smith M&P, Ruger SR9, Sig 229) | \$22.99

Sportster® Leather Ambidextrous Belt Slide Holster

- Ambidextrous design
- Constructed of top-quality Italian leather with spring-steel clip
- Belt clip for inside-the-pants wear and belt loops for outside carry
- Two sizes fit most common carry guns

Small | 74LH00 | BK | Small Frame 22/25/380 Autos | \$39.99
Medium/Large | 74LH01 | BK | Medium and Most Large-Frame 9/40/45
Autos | \$39.99



Sportster™ Single-Point Sling with Nylon Mount

- Constructed of durable 1.25" nylon webbing
- Robust bar tacking and box stitching for maximum strength
- Simple single-point sling design for use with rifles and shotguns
- Ambidextrous design for easy left- or right-hand use
- Strong latch hook for quick, positive firearm attachment
- Adjustable length to fit a variety of body sizes
- Integrated side-release buckle for quick sling removal
- Includes universal mount to accommodate sling use with wide variety of firearms (not shown)

74GS19 | BK | \$24.99





Knox® Technology

If you're a hunter, sport shooter or law enforcement officer, you're probably well-acquainted with the many bruises, welts and aches associated with shoulder-pounding recoil. But thanks to our Knox recoil-reducing technology, you'll never look at large-caliber rifles or shotguns the same way. This patented technology integrates a powerful extension spring system into the stock to significantly cut muzzle rise for faster target reacquisition and to help reduce felt recoil of even the most potent loads. It effectively eliminates shoulder fatigue, harsh recoil and related injuries, giving you confidence to make the shot.

Knox stocks with dual recoil-compensation systems incorporate two springs inside the stock while models with a single recoil-compensation system incorporate one spring into the design. Each stock is carefully crafted to give you just the right amount of recoil reduction, depending on its intended application.





Shotgun Stocks

Whether you're looking for an economical recoil solution for the job or planning to take down a trophy buck, we have plenty of options for our shotgun-toting customers. Each Knoxx® shotgun stock comes equipped with the following standard features:

for more: **You Tube**
youtube.com/bpggear

- Ambidextrous design
- Durable, lightweight polymer and alloy construction
- Includes matching composite forend (except SpecOps Folder™ and BreachersGrip™)
- Multiple Integrated ambidextrous sling mounting locations
- Quick and easy single-bolt installation
- All-weather performance



Adjustable seven-position stock

Integrated rubber grip inserts



Next G-1 camo pattern

Knoxx® SpecOps Stock Gen II™

The SpecOps Stock Gen II takes the original SpecOps Stock to an even higher level of effectiveness, performance and reliability. Whether you're a hunter or sport shooter, law enforcement or military personnel, you'll get much-needed relief from painful kickback.

- Includes all standard Knoxx® shotgun stock features (see above)
- Dual recoil-compensation systems reduce harsh recoil
- Ergonomic pistol grip with interchangeable rubber grip inserts
- Rapid-adjust, seven-position stock to fit all shooters (11.25" to 15" length-of-pull)

K07100-C | Black | Remington® 870 12 Gauge (All Varieties) | \$134.99
 K07200-C | Black | Mossberg® 12 Gauge (Models 500, 535, 590, 835, 88) | \$134.99
 K07101-C | Next G-1 | Remington® 870 12 Gauge (All Varieties) | \$159.99
 K07201-C | Next G-1 | Mossberg® 12 Gauge (Models 500, 535, 590, 835, 88) | \$159.99





Knox® SpecOps NRS™ Gen II

The SpecOps NRS Gen II gives law enforcement officers, hunters and general shooting enthusiasts a performance-packed shotgun stock in a non-recoil-suppressing package. It's ideal for shooters seeking to improve firearm control, ensure proper fit and increase overall shotgun effectiveness.

- Includes all standard Knox® shotgun stock features (see page 240)
- No recoil-compensation systems
- Ergonomic pistol grip with integrated rubber grip inserts
- Rapid-adjust, seven-position stock to fit all shooters (11.25" to 15" length-of-pull)

K30100-C | Black | Remington® 870 12 Gauge (All Varieties) | \$74.99
 K30200-C | Black | Mossberg® 12 Gauge (Models 500, 535, 590, 835, 88) | \$74.99
 K30501-C | Less Lethal Orange | Remington® 870 12 Gauge (All Varieties) | \$74.99



Knox® PowerPak System™

The innovative PowerPak System brings a new level of versatility and performance to our Knox SpecOps models. This four-piece modular system is designed for rigid and stable use in the toughest of environments.

- Ambidextrous design
- High cheek piece for use with raised optics
- Low cheek piece for use with low-rise sights
- Shell holder carries five 12-gauge shells for quick reloads
- Watertight storage compartment for spare CR123A batteries or similar-sized items
- Designed specifically for use with all versions of the SpecOps Stock™, SpecOps Stock Gen II™, and SpecOps NRS™ Gen II (sold separately, see page 240 – 241)

K04009-C | Black | \$39.99
 K04019-C | Next G-1 | \$69.99

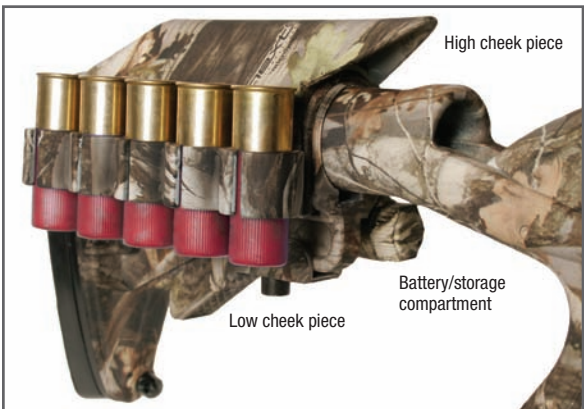

for more: **You Tube**
[youtube.com/bpgegear](https://www.youtube.com/bpgegear)

Knoxx® Talon Thumbhole Stock

The Talon Thumbhole Stock is the engineered fusion of our patented Knoxx recoil-reducing technology, ergonomic control of a pistol grip and time-tested elements of a traditional thumbhole stock. Reliable and built to last, this stock will help improve accuracy, target reacquisition times and firearm control.

- Includes all standard Knoxx® shotgun stock features (see page 240)
- Dual recoil-compensation systems reduce harsh recoil
- Ergonomic pistol grip with integrated rubber grip inserts
- Comfortable 13.75" length-of-pull
- Traditional comb design for comfort and consistent target acquisition

K06100-C | Black | Remington® 870 12 Gauge (All Varieties) | \$144.99
 K06200-C | Black | Mossberg® 12 Gauge (Models 500, 535, 590, 835, 88) | \$144.99
 K06101-C | Next G-1 | Remington® 870 12 Gauge (All Varieties) | \$169.99
 K06201-C | Next G-1 | Mossberg® 12 Gauge (Models 500, 535, 590, 835, 88) | \$169.99



Integrated rubber grip inserts



Convenient rear storage compartment (14 cu. in.)



Dual recoil-compensation systems

Knoxx® Replacement Shotgun Forend

Need a quality replacement forend to complement your Knoxx or existing shotgun stock? Look no further. This forend provides a secure gripping surface in a rugged design.

- Durable, lightweight composite construction with polymer reinforcement
- Ergonomic grip with integrated textured grooves

K18100-C | Black | Remington® 870 12 Gauge Black | \$19.99
 K18200-C | Black | Mossberg® Pump Action 12 Gauge (Fits 7 5/8" Slide Tube) | \$19.99
 K18220-C | Black | Mossberg® Pump Action 12 Gauge (Fits 6 3/4" Slide Tube) | \$19.99
 K18101-C | Less Lethal Orange | Remington® 870 12 Gauge | \$21.99
 K18221-C | Next G-1 | Mossberg® Pump Action 12 Gauge (Fits 6 3/4" Slide Tube) | \$28.99





Variable ratio
cam recoil system

Knox® BreachersGrip™

The BreachersGrip is the perfect recoil-reducing stock for one-handed operation in close-quarter combat or home defense. It makes firing breaching rounds or heavy-hitting shotgun loads virtually painless.

- Includes all standard Knox® shotgun stock features (see page 240)
- Single recoil-compensation system reduces felt recoil
- Ergonomic pistol grip with integrated non-slip texturing
- Comfortable one-handed operation
- Compact design for easy storage

K02100-C | Black | Remington® 870 12 Gauge (All Varieties) | \$89.99
 K02200-C | Black | Mossberg® 12 Gauge (Models 500, 535, 590, 835, 88) | \$89.99
 K02300-C | Black | Winchester® 1200 & 1300 12 Gauge | \$89.99
 K02400-C | Black | Remington® 20 Gauge & Select Pump/Semi Rifles (Models 870 20 Gauge & 7400, 7600, 7615, 740, 760, 750) | \$89.99

for more: 
youtube.com/bpggear



Knox® SpeOps Folder™

The sleek SpecOps Folder takes the pain out of shooting magnum buckshot and slug loads even when the stock is folded. A sturdy folding wire-frame stock with integral rubber butt pad collapses easily over the receiver for convenient storage and mobility in tight spaces such as vehicles, motorcycles, hallways and entryways.

- Includes all standard Knox® shotgun stock features (see page 240)
- Single recoil-compensation system reduces felt recoil
- Ergonomic pistol grip with integrated non-slip texturing
- Quick-to-operate, rubber-coated, folding wire-frame stock

K01100-C | Black | Remington® 870 12 Gauge (All Varieties) | \$129.99
 K01200-C | Black | Mossberg® 12 Gauge (Models 500, 535, 590, 835, 88) | \$129.99
 K01300-C | Black | Winchester® 1200 & 1300 12 Gauge | \$129.99
 K01400-C | Black | Remington® 20 Gauge & Select Pump/Semi Rifles (Models 870 20 Gauge & 7400, 7600, 7615, 740, 760, 750) | \$129.99



Variable ratio cam recoil system

Knox® CompStock™

Combining modern technology with a traditional design, the shotgun CompStock has been received with enthusiasm for its ability to reduce recoil with both light and heavy loads. Law enforcement officers, who are required to qualify with a shotgun, will find that the CompStock is the secret to higher scores and better field results while hunters and competitive shooters will see improvements in their hit ratios and scores.

- Includes all standard Knox® shotgun stock features (see page 240)
- Single recoil-compensation system reduces felt recoil
- Ergonomic design with integrated grip texture

K05100-C | Black | Remington® 870 12 Gauge (All Varieties) | \$119.99

K05200-C | Black | Mossberg® 12 & 20 Gauge (Models 500, 535, 590, 835, 88) | \$119.99

K05300-C | Black | Winchester® 1200 & 1300 12 Gauge | \$119.99

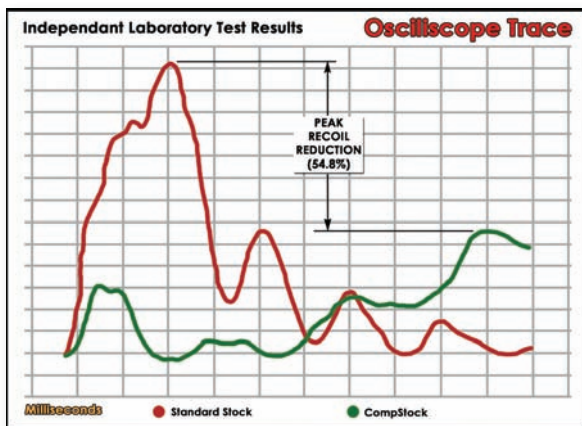

for more: [YouTube](https://www.youtube.com/bpggear)
youtube.com/bpggear



Horizontal variable ratio cam recoil system

Knox® Performance Shotgun Stock

With all the high-performance features of a non-recoil-suppressing Knox stock, this standard shotgun stock meets the upgrade or replacement needs of law enforcement, military and general sport shooting.

- Includes all standard Knox® shotgun stock features (see page 240)
- No recoil-compensation systems
- Ergonomic design with integrated grip texture
- Comfortable 13.75" length-of-pull
- Short Tactical Length model (K09120-C) has 12.5" length-of-pull

K09100-C | Black | Remington® 870 12 Gauge (All Varieties) | \$64.99

K09110-C | Black | Remington® 1100/1187 12 Gauge | \$64.99

K09120-C | Black | Remington® 870 12 Gauge (All Varieties) Short Tactical Length | \$64.99

K09150-C | Less Lethal Orange | Remington® 870 12 Gauge (All Varieties) | \$64.99

K09200-C | Black | Mossberg® All Pump Varieties (Forend Fits 7-5/8" Slide Tube) | \$64.99



Rifle Stocks

Knox® rifle stocks give hunters, shooting enthusiasts and law enforcement personnel the same recoil-absorbing Knox technology but in a package that's especially designed to accommodate your prized rifle. Each Knox rifle stock comes equipped with the following standard features:

- Ambidextrous design
- Durable, lightweight fiberglass-reinforced polymer and alloy construction with aluminum pillars
- Ergonomic pistol grip with integrated rubber grip inserts (except Rifle CompStock™)
- Multiple Integrated ambidextrous sling mounting locations
- Completely free-floated barrel channel fits all barrel diameters
- Quick and easy drop-in installation
- All-weather performance
- Precision receiver fit

Knox® Axiom™ Ultra-Light Rifle Stock

Weighing in at only 2 lbs. 9 oz., this stock delivers remarkable comfort while shooting bolt-action rifles and draws out your rifle's full accuracy potential without the punishing recoil found with most large calibers.

- Includes all standard Knox® rifle stock features (see above)
- Dual recoil-compensation systems reduce harsh recoil
- Rapid-adjust, five-position stock to fit all shooters (11.25" to 15.25" length-of-pull)

K97000-C | Black | Remington® 700 BDL Short Action | \$249.99

K97001-C | Black | Remington® 700 BDL Long Action | \$249.99

K97500-C | Black | Weatherby® Vanguard/Howa 1500 Short Action | \$249.99

K97501-C | Black | Weatherby® Vanguard/Howa 1500 Long Action | \$249.99

K97010-C | King's Desert Shadow® | Remington® 700 BDL Short Action | \$299.99

K97011-C | King's Desert Shadow® | Remington® 700 BDL Long Action | \$299.99

K97510-C | King's Desert Shadow® | Weatherby® Vanguard/Howa 1500 BDL Short Action | \$299.99

K97511-C | King's Desert Shadow® | Weatherby® Vanguard/Howa 1500 BDL Long Action | \$299.99



Adjustable rear stock



Free-floated barrel channel

Knox® Axiom™ Ultra-Light Raised Cheek Piece

- Designed for medium or high mounted scopes and optics

K99900-C | Black | \$16.99

Note: All Knox® Axiom™ Ultra-Light Stock images shown with optional Ultra-Light Raised Cheek Piece accessory.





Knox® Axiom™ II UL™ Rifle Stock

Take your shooting experience to a dominant level with faster target reacquisition, increased accuracy and improved shooter confidence with the Axiom II UL Rifle Stock. It gives law enforcement personnel, hunters and shooting enthusiasts alike the ability to reduce felt recoil.

- Includes all standard Knox® rifle stock features (see page 245)
- Dual recoil-compensation systems reduce harsh recoil
- Ergonomic pistol grip and forend with interchangeable rubber grip inserts
- Rapid-adjust, seven-position stock to fit all shooters (11.25" to 15" length-of-pull)

K94000-C | Black | Remington® 700 BDL Short Action (All Varieties) | \$189.99
 K94001-C | Black | Remington® 700 BDL Long Action (All Varieties) | \$189.99
 K94010-C | King's Desert Shadow® | Remington® 700 BDL Short Action (All Varieties) | \$219.99
 K94011-C | King's Desert Shadow® | Remington® 700 BDL Long Action (All Varieties) | \$219.99



Dual recoil-compensation systems



King's Desert Shadow® camo shown

Knox® Axiom™ TH Thumbhole Rifle Stock

Whether you're firing hard-hitting big-game ammunition or shoulder-pounding magnum loads, this thumbhole stock lets you comfortably use rifles in a variety of shooting positions and makes all rifle calibers easy for any shooter to handle.

- Includes all standard Knox® rifle stock features (see page 245)
- Dual recoil-compensation systems reduce harsh recoil
- Comfortable 13.75" length-of-pull
- Traditional comb design for comfort and consistent target acquisition
- Convenient rear storage compartment (14 cu. in.)
- Compatible with bipods (sold separately, see page 228 – 229)

K92000-C | Black | Remington® 700 BDL Short Action | \$259.99
 K92001-C | Black | Remington® 700 BDL Long Action | \$259.99
 K92500-C | Black | Weatherby® Vanguard/Howa 1500 BDL Short Action | \$259.99
 K92501-C | Black | Weatherby® Vanguard/Howa 1500 BDL Long Action | \$259.99
 K92010-C | King's Desert Shadow® | Remington® 700 BDL Short Action | \$299.99
 K92011-C | King's Desert Shadow® | Remington® 700 BDL Long Action | \$299.99
 K92510-C | King's Desert Shadow® | Weatherby® Vanguard/Howa 1500 BDL Short Action | \$299.99
 K92511-C | King's Desert Shadow® | Weatherby® Vanguard/Howa 1500 BDL Long Action | \$299.99



Convenient rear storage compartment (14 cu. in.)



King's Desert Shadow® camo shown

Knox® Axiom™ II TH™ Rifle Stock

Incorporating a traditional-style rifle forend, ambidextrous thumbhole pistol grip and dual recoil-compensation systems, the Axiom II TH promises to elevate overall rifle and shooter performance while significantly slashing recoil.

- Includes all standard Knox® rifle stock features (see page 245)
- Dual recoil-compensation systems reduce harsh recoil
- Ergonomic thumbhole pistol grip and forend with interchangeable rubber grip inserts
- Traditional comb and forend design for comfort and consistent target acquisition
- Comfortable 13.75" length-of-pull
- Convenient rear storage compartment (14 cu. in.)
- Compatible with bipods (sold separately, see page 228 – 229)

K93000-C | Black | Remington® 700 BDL Short Action | \$189.99
 K93001-C | Black | Remington® 700 BDL Long Action | \$189.99
 K93010-C | King's Desert Shadow® | Remington® 700 BDL Short Action | \$219.99
 K93011-C | King's Desert Shadow® | Remington® 700 BDL Long Action | \$219.99



Dual recoil-compensation systems



Convenient rear storage compartment (14 cu. in.)



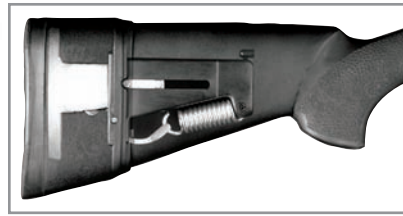

Horizontal variable ratio cam recoil system

for more: **You Tube**
youtube.com/bpggear

Knox® Rifle CompStock™

The high-performance Rifle CompStock offers maximum recoil reduction for large-caliber bolt-action rifles and is ideal for field or range use. This traditional stock eliminates the pain of punishing recoil—perfect for experienced and novice shooters alike.

- Includes all standard Knox® rifle stock features (see page 245)
- Single recoil-compensation system reduces felt recoil
- Hogue® overmolded composite stocks

Remington® 700 BDL & Sendero (ADL requires BDL conversion kit)
 K70000-C | Black | Short Pillar Bed Standard Barrel | \$249.99
 K70001-C | Black | Short Pillar Bed Heavy Barrel | \$249.99
 K70010-C | Black | Long Pillar Bed Standard Barrel | \$249.99
 K70011-C | Black | Long Pillar Bed Heavy Barrel | \$249.99

Ruger® 77 MKII (Only fits MKII models)

K70200-C | Black | Short Pillar Bed Standard Barrel | \$249.99
 K70201-C | Black | Short Pillar Bed Heavy Barrel | \$249.99
 K70210-C | Black | Long Pillar Bed Standard Barrel | \$249.99
 K70211-C | Black | Long Pillar Bed Heavy Barrel | \$249.99

Weatherby® Vanguard/Howa 1500 BDL

K70500-C | Black | Short Pillar Bed Standard Barrel | \$249.99
 K70501-C | Black | Short Pillar Bed Heavy Barrel | \$249.99
 K70510-C | Black | Long Pillar Bed Standard Barrel | \$249.99
 K70511-C | Black | 1500 Long Pillar Bed Heavy Barrel | \$249.99

Winchester® Model 70 (Not available for pre-1964 models)

K70100-C | Black | Short Pillar Bed Standard Barrel | \$249.99
 K70101-C | Black | Short Pillar Bed Heavy Barrel | \$249.99
 K70110-C | Black | Long Pillar Bed Standard Barrel | \$249.99
 K70111-C | Black | Long Pillar Bed Heavy Barrel | \$249.99
 K70140-C | Black | WSM Pillar Bed | \$249.99

Mauser® 98 & Most Variants

K70310-C | Black | Long Pillar Bed Standard Barrel | \$249.99



Knox® Replacement Adjustable Carbine Rifle Buttstock

This durable, high-impact polymer carbine buttstock is designed for quick and easy adjustment with multiple sling attachment options.

- Reinforced polymer construction
- Precision fit for quick and smooth length adjustment
- Designed for comfortable cheek weld
- Ambidextrous sling mounting locations with preinstalled 1" quick-detach sling swivel
- Different models available to fit commercial or military-sized carbine tubes
- Measure rear tube diameter to determine fit (Commercial = 1.170" or MIL = 1.146")

K11001-C | Black | Commercial Size Tube AR/M4 | \$49.99
 K11011-C | Olive Drab | Commercial Size Tube AR/M4 | \$49.99
 K11021-C | Desert Tan | Commercial Size Tube AR/M4 | \$49.99
 K11000-C | Black | Military Size Tube AR/M4 | \$49.99
 K11010-C | Olive Drab | Military Size Tube AR/M4 | \$49.99
 K11020-C | Desert Tan | Military Size Tube AR/M4 | \$49.99



The Replacement Adjustable Carbine Rifle Buttstock is color matched to our on-gun accessories (see page 187 – 190).



Knox® Axiom™ R/F Ruger® 10/22® Rifle Stock

This lightweight stock takes Ruger 10/22 rifles to the next level of performance, functionality and accuracy by incorporating rugged polymer-reinforced construction, adjustable length-of-pull and non-slip pistol grip.

- Includes all standard Knox® rifle stock features (see page 245)
- No recoil-compensation systems
- Rapid-adjust, six-position stock to fit all shooters (9.75" to 13.5" length-of-pull)
- Compatible with bipods (sold separately, see page 228 – 229)
- Weighs 1 lb. 2 oz.

K98200-C | Black | \$89.99

K98201-C | Foliage Green | \$89.99

K98202-C | Coyote Tan | \$89.99



Adjustable rear stock

Comfortable pistol grip



Knox® Axiom™ R/F Ruger® 22 Charger Stock

Designed to accommodate your Ruger 22 Charger, this stock is the perfect replacement stock for recreational shooting, giving you all the durability and performance you expect from the Knox product line.

- Includes all standard Knox® rifle stock features (see page 245)
- No recoil-compensation systems
- Pre-installed, quick-detach 1" sling swivel
- Compatible with bipods (sold separately, see page 228 – 229) and single-point slings (sold separately, see page 178 – 184)

K98300-C | Black | \$49.99



Free-floated barrel channel

Thigh Rigs

Materials and Workmanship

Effectively and efficiently transfer some of your tactical load from your upper body to your hips and legs with our tactical thigh rigs (patent #D500807). Many of these proven designs come equipped with the following standard features:

- Constructed of abrasion- and mildew-resistant 500 or 1000 denier nylon with closed-cell foam
- IVS™ (Intercooler Venting System) back panel for ventilation
- Drainage grommets in bottom of pouches
- ALICE clip configuration for attaching to vests, packs, etc.
- Belt-mounted configuration
- High-ride drop-leg configuration with one rubberized leg strap
- Low-ride drop-leg configuration with two rubberized leg straps



All pouches and mag cases sold separately

Modular Drop-Leg Platform

Build your own tactical thigh rig platform with the Modular Drop-Leg Platform and Duty Accessory Mounting Screw Kit (each sold separately).

- Constructed of high-density polymer for comfort and flexibility
- Y-harness configuration with heavy-duty hanger straps and quick-release buckles
- Dual non-slip BTS™ belt loops
- Removable 1.5" non-slip upper leg strap and 2" non-slip lower leg strap for maximum stability
- Ventilated for increased airflow
- Replacement Leg Straps available for 1.5" upper leg strap (45BW001) and 2" lower leg strap (45BW002)
- Four adjustable accessory rails hold four BLACKHAWK!® pouches (sold separately, see page 196 – 214), mag/light carriers (sold separately, see page 147 – 149) or duty gear accessories (sold separately, see page 89 – 93)

432300P | BK, CT, OD, FG | \$69.99

Duty Accessory Mounting Screw Kit

- Required for mounting BLACKHAWK!® duty gear accessories onto Modular Drop-Leg Platform (sold separately, see left) or SERPA® Tactical Holster Platform (sold separately, see page 128)

44AK0001 | \$4.99

Contact Customer Service at 800.694.5263 to order Replacement Leg Straps.



S.T.R.I.K.E.® Compact Drop-Leg Platform **NEW!**

- Constructed of 500 denier nylon
- Modular drop-leg platform with reduced footprint
- 1.5" wide elastic rubberized leg strap for stability and comfort
- Y-harness configuration and heavy-duty hanger straps with quick-detach swivel buckles
- Tapered, foam-padded platform
- Three rows of S.T.R.I.K.E.® webbing for attaching pouches or accessories
- Dimensions: 5.5"L x 9"W (main comp.)
- Weight: 0.60 lbs.

37CL125 | BK, CT, OD, MC | \$34.99 (MC = \$42.99)



**Omega Elite™ Triple Pistol/
Double Cuff Pouch**

- Includes all standard thigh rig features (see page 250)
- Fully adjustable triple pistol mag pouches for tall or short mags
- Cuff pouch holds two sets of standard cuffs
- Divider for quick, silent access
- Triple pistol mag pouches and double cuff pouch

56TPDC | BK | \$64.99



**Omega Elite™ Double Pistol/
Single Cuff Pouch**

- Includes all standard thigh rig features (see page 250)
- Fully adjustable double pistol mag pouches for tall or short mags
- Cuff pouch holds standard cuffs (one set)

56PMCP | BK | \$49.99



Omega Elite™ Drop-Leg Extender

- Extends gear below belt by five inches
- Attaches to drop-leg holsters, pouches and rigs

56DLE2 | BK | \$10.99



Securely mount to thigh and belt



Quick access to critical medical supplies (not included)



Add Red Cross Medic ID Patch (sold separately, see page 195)

Omega Elite™ Modular Drop-Leg Medical Pouch

- Includes all standard thigh rig features (see page 250)
- Securely mounts to thigh, belt or vest

56MP00 | BK, OD, AU | NSN# 6545-01-504-3085 (BK), NSN# 6545-01-533-5369 (AU) | \$64.99



Omega Elite™ SMG Mag Pouch

- Includes all standard thigh rig features (see page 250)
- Flaps secured by silent side-release buckles
- Holds three 9mm SMG (56SMG3) magazines or 9mm/40 cal or UMP 45 magazines (56SM40)

9mm SMG | 56SMG3 | BK | \$64.99

9mm/40 Cal/UMP 45 | 56SM40 | BK | \$64.99



M16 "Y" Thigh Rig

- Drop-leg configuration holds four M16 magazines
- Constructed of lightweight yet durable 500 denier ripstop
- Two mag pouches on front hold two M16 magazines each
- Y-configuration with heavy-duty hanger straps and quick-detach swivel buckles
- Elastic rubberized leg straps for stability and comfort
- Fully adjustable lid height
- Dimensions: 2.75"L x 2"W (pouches)

561604 | BK, CT | \$64.99



Omega Elite™ Enhanced Dual M16/Pistol Mag Pouch

- Includes all standard thigh rig features (see page 250)
- Carries two M16/M4 30-round magazines and two pistol magazines
- Pouch dividers prevent magazine clatter and enhance noise discipline
- Fully adjustable pistol mag pouch lids for tall or extended magazines

5616PM | BK | \$64.99



Omega Elite™ M16/Flashbang Pouch

- Includes all standard thigh rig features (see page 250)
- Holds two 30-round .223 cal. mags and two flashbangs
- Flaps secured by silent side-release buckles
- Fits dual MP5 9mm with H-Clip

56M6FB | BK | \$64.99



Omega Elite™ M16 Mag Pouch

- Includes all standard thigh rig features (see page 250)
- Carries two M16/M4 30-round magazines

561601 | BK | \$64.99



Omega Elite™ Enhanced M16 Drop-Leg Mag Pouch

- Includes all standard thigh rig features (see page 250)
- Pouch dividers prevent mag clatter and enhance noise discipline
- Carries four M16/M4 30-round mags

561602 | BK, DE | \$64.99



S.T.R.I.K.E.® Drop-Leg Platform

- Constructed of 1000 denier nylon
- Multiple rows of S.T.R.I.K.E.® webbing for attaching pouches or accessories
- Elastic rubberized leg straps for stability and comfort

37CL39 | BK, CT, OD | \$59.99

WHILE SUPPLIES LAST (OD)



Ultralight Omega Elite™ Gas Mask Pouch

- Constructed of lightweight 500 denier ripstop nylon
- Adjustable, removable shoulder strap and non-slip leg straps
- Y-harness configuration with heavy-duty hanger straps and quick-release swivel buckles
- Side-release buckles and hook & loop closure
- Dual non-slip BTS™ belt loops
- 1/8" padded back
- Weight: 1 lb. 6 oz.

56GM03 | BK | \$74.99



Omega Elite™ Dump Pouch

- Includes all standard thigh rig features (see page 250)
- Designed to carry loose ordinance, empty magazines, evidence or contraband
- High-quality YKK® zippers
- Top hook & loop flap with heavy-duty elastic for quick loading and secure carry
- Heavy-duty D-rings for should strap attachment
- 3" x 6" front accessory pouch with side-release buckle and hook & loop closure

56DP00 | BK, OD, DE | \$64.99



Omega Elite™ Gas Mask Pouch

- Includes all standard thigh rig features (see page 250)
- Adjustable, removable shoulder strap
- Heavy-duty drop-leg hanger with BTS™ belt loops
- Side-release buckles and hook & loop closure

56GM00 | BK | NSN# 4210-01-504-3082 | \$64.99



Escape and Evasion H/V Drop Pouch **WHILE SUPPLIES LAST**

- Can be worn horizontally or vertically, high or low on belt
- Two compartments secured by #9 YKK® zippers and silent zipper pulls
- Dimensions: 5"L x 7.5"W x 3"D = 135 cu. in.

50EE01 | BK | \$33.99



Workmanship

Through continued R&D efforts and with input from operators in the field, we've designed the most tactically advanced load-bearing vests available. Many of these combat-proven designs come equipped with the following standard features:

- Adjustable for length and girth (up to 6" length and 32" girth)
- Heavy-duty YKK® zipper and side-release buckles for rapid donning and doffing
- Belt loops secure vest to web belt (sold separately, see page 81 – 85) for stability when accessing gear and security during operations
- Reinforced drag handle for operator evacuation if injured
- S.T.R.I.K.E.® webbing for attaching pouches or accessories (except Urban Assault Vest)



Did you know? S.T.R.I.K.E.® webbing—our version of popular PALS/MOLLE webbing—is used to attach smaller pouches or accessories onto load-bearing platforms. See our full line of modular pouches on page 196 – 214.

Cutaway Omega™ Vest

- Includes all standard vest features (see page 254)
- Constructed of durable nylon mesh for maximum breathability
- Simple cutaway technology with secure release strap and rounded handle under protective nylon band on front shoulder
- Padded non-slip sniper shoulders for fully ambidextrous vest
- Large internal zippered accessory pockets (8.5”L x 10”W) on both front panels
- Does not include pouches (see page 196 – 214)



30CV01 | BK, CT, MC | \$199.99
(MC = \$234.99)

S.T.R.I.K.E.® Omega™ Vest

- Includes all standard vest features (see page 254)
- Constructed of durable nylon mesh for maximum breathability
- Padded non-slip sniper shoulders for fully ambidextrous vest
- Lace-style girth adjustment
- Two large internal zippered map pouches
- Shoulder D-rings for accessory attachment
- Does not include pouches (see page 196 – 214)



37CL36 | BK, CT, OD | \$139.99

S.T.R.I.K.E.® Elite Vest

- Includes all standard vest features (see page 254)
- Constructed of durable nylon mesh for maximum breathability
- Padded non-slip sniper shoulders for fully ambidextrous vest
- Side-release buckle and web-style girth adjustment
- Shoulder D-rings for accessory attachment
- Two large internal zippered map pouches
- Does not include pouches (see page 196 – 214)



37CL66 | BK, CT, OD, AU | \$164.99

Quick Tip: Customize your BLACKHAWK!® tactical vest with our expansive selection of nylon pouches (see page 196 – 214).



All pouches sewn on



Omega Elite™ Tactical Vest #1

- Includes all standard vest features (see page 254)
- Constructed of durable nylon mesh for maximum breathability
- Padded non-slip sniper shoulders for fully ambidextrous vest
- Two large internal zippered map pouches
- Mag pouches with adjustable flaps for tall or short magazines
- Two horizontal accessory pouches
- Six M16/M4 mag pouches hold 12 magazines total
- Includes removable shotshell strip

30EV03 | BK, OD, DE | NSN# 8415-01-529-7472 (OD), NSN# 8415-01-529-7471 (DE) | \$179.99



All pouches sewn on



Omega Elite™ Tactical Vest EOD

- Includes all standard vest features (see page 254)
- Constructed of durable nylon mesh for maximum breathability
- Padded non-slip sniper shoulders for fully ambidextrous vest
- Shoulder D-rings for accessory attachment
- Two large internal zippered map pouches
- Hook & loop strip for ID patch
- Mag pouches with adjustable flaps for tall or short magazines
- Four horizontal accessory pouches
- Three M16/M4 mag pouches hold six magazines total
- Pistol mag/flashlight pouch
- Includes removable shotshell strip

30EV05 | BK, OD, DE | NSN# 8415-01-529-7475 (BK), NSN# 8415-01-529-7473 (DE) | \$179.99



All pouches sewn on



Omega™ Tac Shotgun/Rifle Vest

- Includes all standard vest features (see page 254)
- Constructed of durable nylon mesh for maximum breathability
- Padded non-slip sniper shoulders for fully ambidextrous vest
- Two large internal zippered map pouches
- Hook & loop strip for ID patch
- Mag pouches with adjustable flaps for tall or short magazines
- One horizontal accessory pouch
- Three M16/M4 pouches hold six magazines total
- Holds 28 shotshells in two pouches

30EV31 | BK | \$179.99



All pouches sewn on

Omega™ Phalanx Homeland Security Vest

- Includes all standard vest features (see page 254)
- Constructed of durable nylon mesh for maximum breathability
- Padded non-slip sniper shoulders for fully ambidextrous vest
- Two large internal zippered map pouches
- Two M16/M4 pouches hold four magazines total (one has a securing cord for radio)
- Mag pouches with adjustable flaps for tall or short magazines
- Pouches for flashbangs, handcuffs, O.C. spray and tactical light
- 14-round shotshell pouch
- Includes removable shotshell strip

30EV35 | BK | \$179.99



All pouches sewn on



Omega™ Tactical Vest Medic/Utility

- Includes all standard vest features (see page 254)
- Constructed of durable nylon mesh for maximum breathability
- Padded non-slip sniper shoulders for fully ambidextrous vest
- Two large internal zippered map pouches
- Hook & loop strip for ID patch
- Eight utility pouches for medical supplies and gear

30EV08 | BK | \$179.99

Omega Elite™ Cross Draw/EOD Vest

- Includes all standard vest features (see page 254)
- Constructed of durable nylon mesh for maximum breathability
- Padded non-slip sniper shoulders for fully ambidextrous vest
- Two large internal zippered map pouches
- Two hook & loop strips for ID patch
- Cross-draw holster secured by adjustable side-release buckle
- One horizontal pistol mag/light/knife pouch
- Four large utility pouches

30EV25 | BK | \$179.99



All pouches sewn on

Omega Elite™ Cross Draw/Pistol Mag Vest

- Includes all standard vest features (see page 254)
- Constructed of durable nylon mesh for maximum breathability
- Padded non-slip sniper shoulders for fully ambidextrous vest
- Two large internal zippered map pouches
- Cross-draw holster secured by adjustable side-release buckle
- Mag pouches with adjustable flaps for tall or short magazines
- Three M16/M4 pouches hold six magazines total
- Four pistol magazine pouches
- One horizontal accessory pouch

30EV26 | BK, BK-Left, DE, DE-Left, OD | NSN# 8415-01-517-6322
(BK), NSN# 8470-01-520-5936 (DE) | \$179.99



All pouches sewn on

Omega Elite™ Operator Vest – 40mm/Rifle

- Includes all standard vest features (see page 254)
- Constructed of durable nylon mesh for maximum breathability
- Padded non-slip sniper shoulders for fully ambidextrous vest
- Two large internal zippered map pouches
- Mag pouches with adjustable flaps for tall or short magazines
- Three M16/M4 pouches hold six magazines total
- One horizontal accessory pouch with hook & loop strip for ID patch
- Eight 40mm pouches

30EV29 | OD | \$179.99



All pouches sewn on

D.O.A.V. Assault Vest System

- Includes all standard vest features (see page 254)
- Constructed of durable nylon mesh for maximum breathability
- Padded non-slip sniper shoulders for fully ambidextrous vest
- Shoulder D-rings for accessory attachment
- Two large internal zippered map pouches
- Four M16/M4 pouches with internal securing straps and dividers hold three magazines each
- Three utility/flashbang pouches
- Five internal elastic keepers for pens, chem-lights, etc.
- Side light/utility/flashbang pouch
- Two large daypacks on back for gear, helmets, radio, etc.

30DV00 | BK | \$199.99



All pouches sewn on

Urban Assault Vest

- Includes all standard vest features (see page 254)
- Constructed of durable nylon mesh for maximum breathability
- Padded non-slip sniper shoulders for fully ambidextrous vest
- Shoulder D-rings for accessory attachment
- Two large internal zippered map pouches
- Mag pouches with adjustable flaps for tall or short magazines
- Radio pouch with cover flap and wire routing
- Four M16/M4 pouches hold eight magazines total
- Hook & loop strips on front and back for ID patch

33UA00 | BK | \$139.99



All pouches sewn on

Tactical Float Vest II

- Includes all standard vest features (see page 254)
- Constructed of heavy-duty 1000 denier nylon for maximum strength and durability
- U.S. Coast Guard-approved foam
- Non-slip right shoulder for proper stock-weld
- Shoulder D-rings for accessory attachment
- Mag pouches with adjustable flaps for tall or short magazines
- Two large internal map pockets
- Two M16/M4 ammo pouches on front hold six magazines total
- Pouches secured with side-release buckles and hook & loop
- Cargo pocket with elastic weave for small items
- Strobe/compass pouch secured by hook & loop flap
- Cargo pocket for medical kit (not included) on right-front panel
- Pouch for Mark 13 day/night flare
- Pocket for several pencil flares and chem-lights
- Small pocket for crotch straps on back secure to front of vest
- Weight: 4 lbs. 3 oz.

30TFV2 | BK | NSN 8415-01-522-1019 (BK) | \$199.99



All pouches sewn on





All pouches sewn on

Enhanced Soldier Load Bearing Vest

- Includes all standard vest features (see page 254)
- Panels constructed of durable nylon mesh for maximum breathability
- Pouches constructed of dual-layer 1000 denier nylon
- Contoured shoulder lined with .5" closed-cell foam
- Metal D-rings for buttpack attachment
- Internal panels with YKK® zippered mesh compartments
- Four mag pouches with dividers hold eight M16/M4 magazines total
- Two grenade pouches
- Stealth snap and hook & loop closures on all pouches

31SF03 | DE | \$139.99



All pouches sewn on



First Responder's Vest

- Includes all standard vest features (see page 254)
- Constructed of durable nylon mesh for maximum breathability
- Two large internal zippered map pouches
- Eight utility pouches for medical supplies and gear
- Hook & loop strip for ID patch
- Reflective gray piping

30RV08 | BK, RD | \$189.99



Initial Response Vest

- Reinforced drag handle
- Adjustable for length and girth
- S.T.R.I.K.E.® webbing for attaching pouches or accessories
- Accommodates 100-oz. hydration reservoir (sold separately, see page 80)
- Reflective gray piping and zipper pulls
- Can be worn alone or with other Initial Response items (sold separately, see page 72, 77, 85 and 172)

31RV01 | BK | \$199.99

Watches

These precision timepieces have been crafted using the finest materials and state-of-the-art technology to ensure years of reliable service. Each watch is fully equipped with the following standard features:

- Constructed of highly corrosion-resistant 316L stainless steel
- Case is precision milled for maximum waterproofness
- Scratch-resistant crystal
- PVD finish is electrochemically bonded to stainless surface
- Precision Miyota quartz movements for extreme accuracy
- Screw-down crowns protect inside from moisture and other elements
- Standard lug design for easy strap replacement
- Billet screw-off case back for simple battery change
- Standard two-year warranty against manufacturing defects

Field Operator™ Watch **NEW!**

The Field Operator Watch is a tool, pure and simple. It's the perfect balance between a blunt instrument and precision timepiece, giving the tactical operative or outdoor enthusiast a quality device that gets the job done. Featuring a straightforward design, it allows for quick modifications when crossing multiple time zones—a must-have function for frequent travelers.

- Includes all standard watch features (see above)
- Case: 316L stainless billet with PVD finish
- Movement: Miyota 2315
- Bezel: Fixed, 24-hour ring
- Waterproof: 100 m
- Strap: Zulu style nylon
- Crystal: Scratch resistant with anti-glare coating
- Case back: Screw down stainless
- Date: No date feature
- Battery: 3 year
- Black (BK) model features black case/strap, orange hands and gray numbers
- Gray (GY) model features black numbers/case/strap and orange hands
- Dimensions: 42.0x50.0 mm (case), 33.0 mm (opening), 9.0 mm (crown), 20.0 mm (strap)

91FW000 | BK, GY | \$159.99





Advanced Field Operator™ Watch **NEW!**

Strong, accurate and lightning fast, the Advanced Field Operator Watch is designed to be read in any physical setting or lighting condition. It marks time under extreme stress to help give you the confidence you need to complete any mission—anywhere, anytime.

- Includes all standard watch features (see page 261)
- Silicone strap resists sweat and chemicals for years
- Case: 316L stainless billet with PVD finish
- Movement: Miyota 2415
- Bezel: Fixed, 24-hour ring
- Waterproof: 100 m
- Strap: Molded silicone
- Crystal: Scratch resistant with anti-glare coating
- Case back: Screw down stainless
- Date: At 4:30 position
- Battery: 3 year
- Black (BK) model features black case/strap, orange hands and luminous hands/numbers
- Stainless (SS) model features stainless case, black strap, orange hands and luminous hands/numbers
- Dimensions: 46.0x54.0 mm (case), 34.0 mm (opening), 9.0 mm (crown), 22.0 mm (strap)

91TW000 | BK, SS | \$199.99



Race Operator™ Watch NEW!

Chronographs are created to record a race win, not second place. And with the Race Operator Watch, victory is the only goal. Featuring unbeatable staying power and precision, this chronographic timepiece is built to perform, come hell or high water.

- Includes all standard watch features (see page 261)
- Chronograph design
- Silicone strap resists sweat and chemicals for years
- Case: 316L stainless billet with PVD finish
- Movement: Miyota OS20, 24-hour full race
- Bezel: Fixed, tachymeter 60-400
- Waterproof: 100 m
- Strap: Molded silicone
- Crystal: Scratch resistant with anti-glare coating
- Case back: Screw down stainless
- Date: At 4:30 position
- Battery: 3 year
- Orange (OR) model features black case/strap, orange hands/numbers and luminous hands/numbers
- Gray (GY) model features gray numbers, black case/strap, orange hands and luminous hands/numbers
- Dimensions: 48.0x55.0 mm (case), 38.0 mm (opening), 9.0 mm (crown)

91CW000 | OR, GY | \$249.99





Deep Sea Operator™ Watch **NEW!**

Diving watches must be built to the highest precision requirements to withstand the forces of pressure, and the diver needs a device that can be viewed clearly in low-light conditions. With these factors in mind, we designed the Deep Sea Operator Watch, giving you everything you need in a quality timepiece—durability, precision and performance.

- Includes all standard watch features (see page 261)
- Meets ISO 6425 water-resistant standards (withstands depths of 300 m)
- Silicone strap resists sweat and chemicals for years
- Case: 316L stainless billet with PVD finish
- Movement: Miyota 2415
- Bezel: Unidirectional diving timer
- Waterproof: 300 m
- Strap: Molded silicone
- Crystal: Scratch resistant with anti-glare coating
- Case back: Screw down stainless
- Date: At 4:30 position
- Battery: 3 year
- Black (BK) model features black case/strap, orange hands and luminous hands/numbers
- Stainless (SS) model features black strap, stainless case, orange hands and luminous hands/numbers
- Dimensions: 48.0x56.0 mm (case), 35.0 mm (opening), 9.0 mm (crown), 24.0 mm (strap)

91DW000 | BK, SS | \$299.99





WOMEN HAVE FIT INTO THE UNIFORM FOR YEARS. IT'S TIME THE UNIFORM FIT THEM.

Introducing the new BLACKHAWK!® women's apparel line, featuring duty/tactical, off-duty and athletic wear that's uniquely tailored for the tactical woman. We've thoughtfully combined the quality of our men's wear with the fit and function you need to perform at your best.



WWW.BLACKHAWK.COM

BLACKHAWK!

HONOR. AS A WAY OF LIFE.®

SCAN HERE TO
LEARN MORE

BLACKHAWK.COM



BLACKHAWK!

6160 COMMANDER PKWY
NORFOLK, VA 23502 USA
BLACKHAWK.com
P - 800.694.5263
F - 888.830.2013

BLACKHAWK!

CELEBRATING 20 YEARS

1993-2013



ATK Sporting features a unique collection of brands that give shooting, tactical and outdoor enthusiasts everything they need in one place. From ammunition, optics and reloading equipment to gun care, hunting and tactical gear, we offer advanced, high-performance products. Look for these leading brands.

A M M U N I T I O N & R E L O A D I N G

O P T I C S & A C C E S S O R I E S



federalpremium.com
1-800-322-2342



cci-ammunition.com
1-800-256-8685



speer-ammo.com
1-800-256-8685



weaveroptics.com
1-800-831-0850



blackhawk.com
1-800-694-5263



championtarget.com
1-800-831-0850



speer-bullets.com
1-800-256-8685



rcbs.com
1-800-533-5000



alliantpowder.com
1-800-276-9337



buckcommander.com
1-800-831-0850



outers-guncare.com
1-800-831-0850



gunslickpro.com
1-800-831-0850



6 48018 19895 3

90BC2013

2013 BLACKHAWK! Catalog